

Ecophon Solo™ Baffle Wave

Solo Baffle Wave is vertically installed unframed baffles. The wave-shaped baffle gives the room a special design and possibility to express design in shape and colour. Baffles are used primarily when natural light is brought into the room via skylight.



Kunika Campus, Kunika, Finland

SYSTEM RANGE



Size, mm	1800x300	1800x600
Special Fixing	•	•
Thickness	40	40
Inst. Diagr.	M495, M419	M495, M419

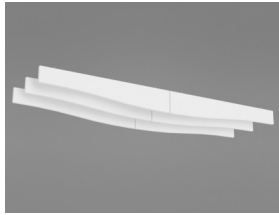

Solo Baffle Wave

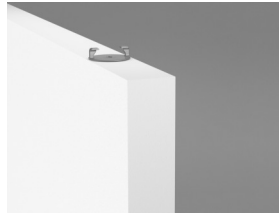

Solo Baffle/Anchor



Solo Baffle/Anchor installation



Solo Baffle/Hook

Acoustic



Sound Absorption:

Test results according to EN ISO 354:2003 NOTE: Results shown are not comparable with results according to older versions of this standard due to discrepancies in test method. Classification according to EN ISO 11654, and the single value ratings for Noise Reduction Coefficient, NRC and Sound Absorption Average, SAA according to ASTM C 423.

α_p , Practical sound absorption coefficient

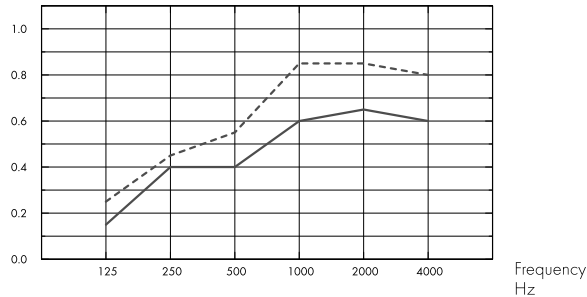

- Solo Baffle Wave 1800x300/200, spacing 600, direct mounting
 - Solo Baffle Wave 1800x600/300, spacing 600, direct mounting
- o.d.s = overall depth of system

A_{eq} , Equivalent absorption area per unit (m^2 sabin)

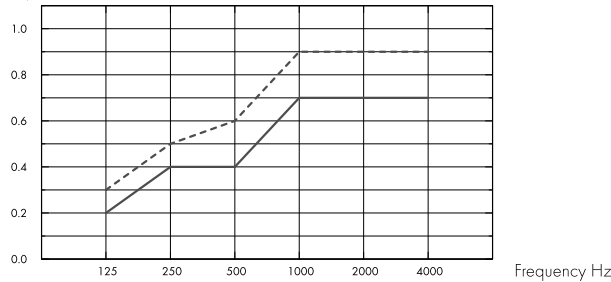

- Solo Baffle Wave 1800x300/200
 - Solo Baffle Wave 1800x600/300
- o.d.s = overall depth of system

	THK mm	o.d.s. mm	α_p , Practical sound absorption coefficient						α_w
			125 Hz	250 Hz	500 Hz	1000 Hz	2000 Hz	4000 Hz	
c600	40	300	0.15	0.40	0.40	0.60	0.65	0.60	0.50
c600	40	600	0.25	0.45	0.55	0.85	0.85	0.80	0.65

	THK mm	o.d.s. mm	A_{eq} , Equivalent absorption area per unit (m^2 sabin)					
			125 Hz	250 Hz	500 Hz	1000 Hz	2000 Hz	4000 Hz
c600	40	300	0.2	0.4	0.4	0.7	0.7	0.7
c600	40	600	0.3	0.5	0.6	0.9	0.9	0.9

THK mm	o.d.s. mm	NRC	SAA
40	300	0.50	0.52
40	600	0.70	0.68



Indoor Air Quality

Certificate / Label	
Eurofins Indoor Air Comfort®	IAC
French VOC	A
Finnish M1	•



Environmental Footprint

	kg CO ₂ equiv./m ²
Solo Baffle Wave	11,07

Life-cycle stages A1 to C4 from EPD, in conformity with ISO 14025 / EN 15804



Circularity

Minimum post-consumer recycled content	57%
Recyclability	Fully recyclable



Fire safety

Country	Standard	Class
Europe	EN 13501-1	A2-s1,d0

The glass wool core of the tiles is tested and classified as non-combustible according to EN ISO 1182.



Humidity Resistance

Class C, relative humidity 95% and 30°C, according to EN 13964:2014



Visual appearance

White Frost, nearest NCS colour sample S 0500-N, 85% light reflectance. Gloss < 1.



Cleanability

Daily dusting and vacuum cleaning. Weekly wet wiping.



Accessibility

The tiles are demountable.



Installation

Installed according to installation diagrams, installation guides and drawing aid. For information regarding minimum overall depth of system see quantity specification.



System weight

Approximate weight of system 2-4 kg/m



Mechanical properties

Additional live load has to be fixed to the soffit.



CE

Ecophon ceiling systems are CE marked according to the European harmonized standard EN 13964:2014. CE marked construction products are covered by a Declaration of Performance (DOP) which enables customers and users to easily compare performance of products available on the European market.

INSTALLATION DIAGRAM (M495) FOR ECOPHON SOLO BAFFLE WAVE/HOOK

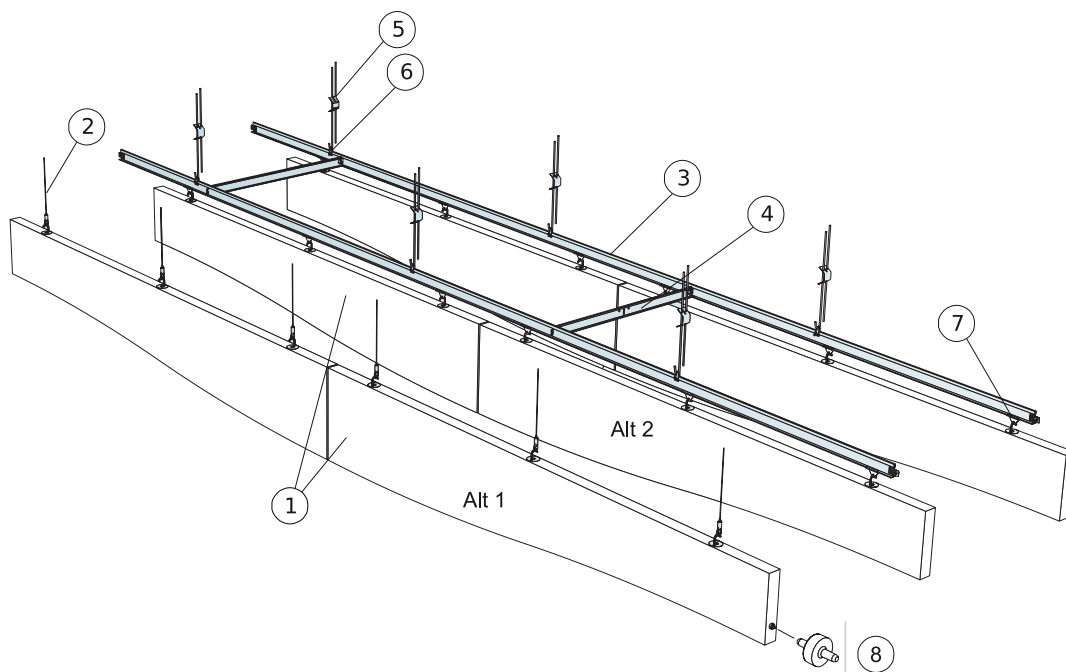

© Ecophon Group

QUANTITY SPECIFICATION (EXCL. WASTAGE)

	Size, mm	
	1800x300	1800x600
1 Solo Baffle/Hook	0,9/m ²	0,9/m ²
2 Connect Adjustable wire hanger (Alt 1)	3/panel	3/panel
3 Connect T24 Main runner, installed at 600 mm centres	1,7m/m ²	1,7m/m ²
4 Connect T24 Cross tee, L=600 mm, installed at 1800 mm centres	0,6m/m ²	0,6m/m ²
5 Connect Adjustable hanger (Alt 2)	1,4/m ²	1,4/m ²
6 Connect Hanger clip (Alt 2)	1,4/m ²	1,4/m ²
7 Connect Baffle clip C3 (Alt 2)	2,8/m ²	2,8/m ²
8 Connect Guiding pin, installed at 1200 mm centres	0,9/m ²	0,9/m ²

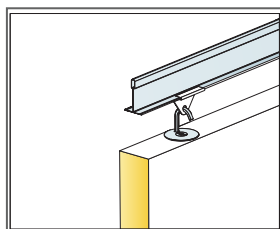

Detail of suspension

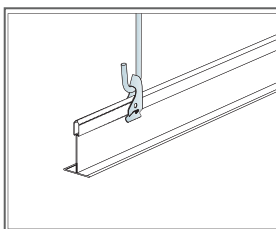

Suspension with adjustable hanger and clip

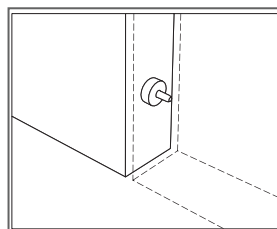

Connect Guiding pin, used to fix distance and level between panels

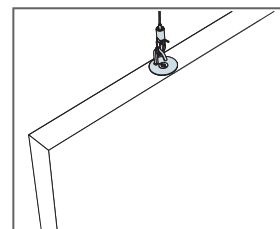

Suspension with Connect Adjustable wire hanger

INSTALLATION DIAGRAM (M419) FOR ECOPHON SOLO BAFFLE WAVE/ANCHOR

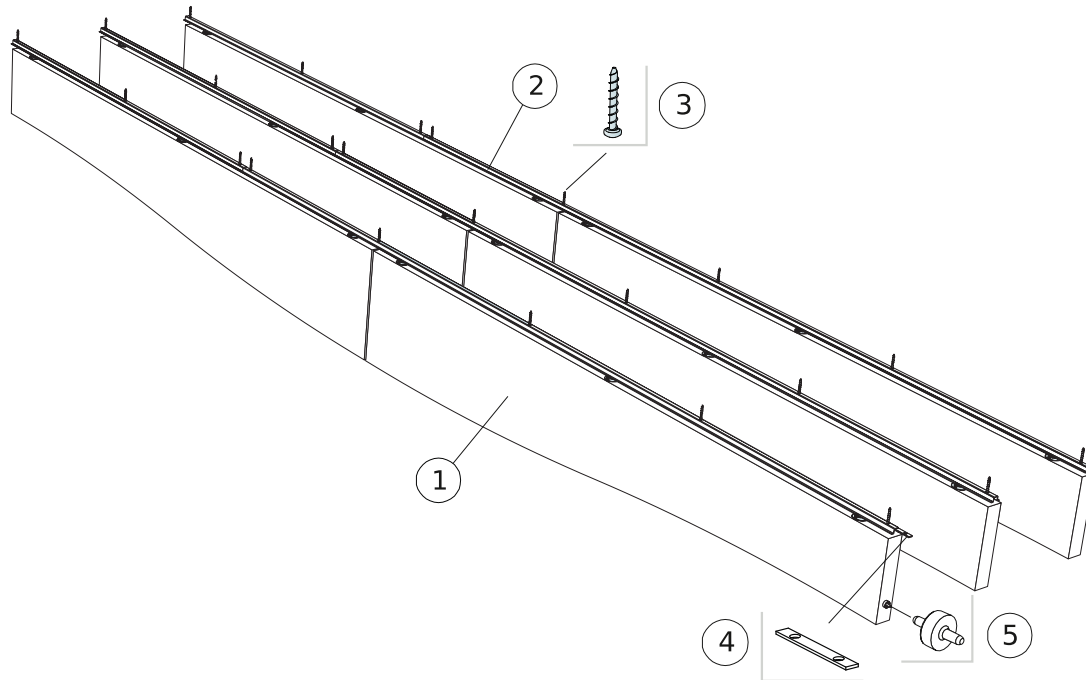

© Ecophon Group

QUANTITY SPECIFICATION (EXCL. WASTAGE)

	Size, mm	
	1800x300	1800x600
1 Solo Baffle/Anchor	1,9/m ²	1,9/m ²
2 Connect Baffle Profile, installed at 300 mm centres	3,3m/m ²	3,3m/m ²
3 Connect Anchor Screw, fixed at 1200 mm centres	2,8/m ²	2,8/m ²
4 Connect Profile connector, installed at 2400 mm centres	1,4/m ²	1,4/m ²
5 Connect Guiding pin, installed at 1800 mm centres	1,9/m ²	1,9/m ²

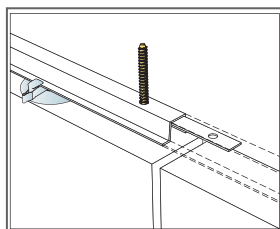

Fixing of Connect Profile connector

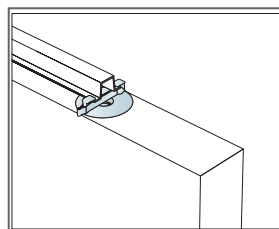

The baffles are secured with clips

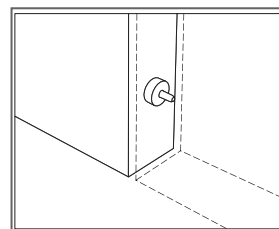

Connect Guiding pin, used to fix distance and level between panels

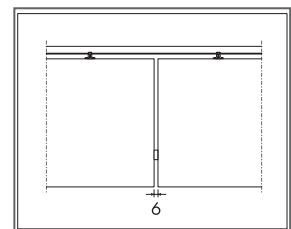

Distinct gap of 6 mm between baffles with Connect Guiding pin