

# SATK22

heat interface unit



Installation Operation & Maintenance Instructions

## SATK22



### Function

The SATK22 HIU allows independent control of heat regulation and domestic hot water production within centralised heating systems or systems served by district heating networks.

The heat interface unit features exceptional flexibility of installation and remote controllable smart electronic functions designed to enhance efficiency of the system.

**NOTE:** Due to the specification ordered, or the country of destination, the actual unit may differ from those shown.

### Product Range

**SATK22103** Direct wall-mounted HIU for **LOW** temperature heating. Domestic hot water capacity 50 kW<sup>1</sup>

**SATK22105** Direct wall-mounted HIU for **LOW** temperature heating. Domestic hot water capacity 60 kW<sup>1</sup>

**SATK22203** Direct wall-mounted HIU for **MEDIUM** temperature heating. Domestic hot water capacity 50 kW<sup>1</sup>

**SATK22205** Direct wall-mounted HIU for **MEDIUM** temperature heating. Domestic hot water capacity 60 kW<sup>1</sup>

**SATK22305** Direct wall-mounted HIU for **HIGH** temperature heating. Domestic hot water capacity 60 kW<sup>1</sup>

**SATK22403** Direct wall-mounted HIU for **HIGH** temperature heating. Domestic hot water capacity 50 kW<sup>1</sup> with primary pump

**SATK22405** Direct wall-mounted HIU for **HIGH** temperature heating. Domestic hot water capacity 60 kW<sup>1</sup> with primary pump

<sup>1</sup> Primary side head > 50 kPa, primary flow temperature 70°C, DHW 10 to 50°C.

### Content

Function	1
Safety instructions	1
Dimensions and connections	3
Technical specification	3
Components & schematic SATK2210 & SATK2220	4
Components & schematic SATK2230 & SATK2240	5
Installation	6
Heat meter installation	8
Electrical connections	8
Remote user interface	11
Commissioning	10
Remote user interface - quick guide	12
Heating functions	13
DHW functions	15
Primary flow rate limitations	17
Circulator - curves and settings	18
Auxiliary microswitch	19
Modbus	20
Safety and alarms	21
Electric circuit board and connections	22
Maintenance	23
Fault finding	26
Check List	27

### Safety Instructions

**WARNING** These instructions must be read and understood before installing and maintaining the HIU.



**CAUTION! FAILURE TO FOLLOW THESE INSTRUCTIONS COULD RESULT IN A SAFETY HAZARD!**

- 1 The device must be installed, commissioned and maintained by qualified technical personnel in accordance with national regulations and/or relevant local requirements.
- 2 If the device is not installed, commissioned and maintained correctly in accordance with the instructions provided in this manual, it may not work correctly and may endanger the user.
- 3 Flush the pipework thoroughly before installing the HIU to remove any particles, rust, incrustations, limescale, welding slag and any other contaminants. The water circuits must be clean and free from debris.
- 4 Make sure that all connection fittings are watertight.
- 5 When connecting water pipes, make sure that threaded connections are not mechanically overstressed. Over time this may result in breakage, causing water damage and/or personal injury.
- 6 Water temperatures higher than 50°C may cause severe burns. When installing, commissioning and maintaining the device, take the necessary precautions so that these temperatures will not be hazardous for people.

## Safety Instructions

- 7 In the case of particularly hard or impure water, there must be suitable provision for filtering and treating the water before it enters the device, in accordance with current legislation. Failure to do so may result in the HIU becoming damaged or working incorrectly.
- 8 Any use of the HIU other than its intended use is prohibited.
- 9 Any coupling of the device with other system components must be made while taking the operational characteristics of both units into consideration.
- 10 An incorrect coupling could compromise the operation of the device and/or system.

**NOTE: Risk of electric shock. Live parts. Shut off the electric supply before opening the HIU cover.**

- 1 During installation and maintenance operations, always avoid direct contact with live or potentially hazardous parts.
- 2 The device must not be exposed to dripping water or humidity, direct sunlight, the elements, heat sources or high intensity electromagnetic fields.  
**This device cannot be used in areas at risk of explosion or fire.**
- 3 The device must be connected to an independent bipolar switch. If work has to be done on the device, switch off the electric supply first. Do not use devices with automatic or time reset, or which may be reset accidentally.
- 4 Use suitable automatic protection devices in compliance with current legislation.
- 5 The device must always be earthed before it is connected to the electric supply. If the device has to be removed, always disconnect the earth connection after disconnecting the electric supply. Check that the earth connection has been made to the highest of standards under current legislation.
- 6 Electrical installation must only be carried out by a qualified technician, in accordance with current requirements.
- 7 The HIU does not contain asbestos or mercury.
- 8 The HIU should only be used by an authorised adult.

## NOTES:

- 1 Install water hammer arresters to compensate for any overpressure in the domestic water circuit.
- 2 In the presence of hot water re-circulation or if a check valve is fitted into the domestic cold water inlet, suitable devices must be used to accommodate the expansion of the medium contained within the system and the heat interface unit.
- 3 All hydraulic connections must be visually checked while pressurising the system. Vibration during transport may cause the connections to become loose. If a fitting needs to be tightened apply an appropriate tightening torque, otherwise the components may become damaged.

## Key to Symbols

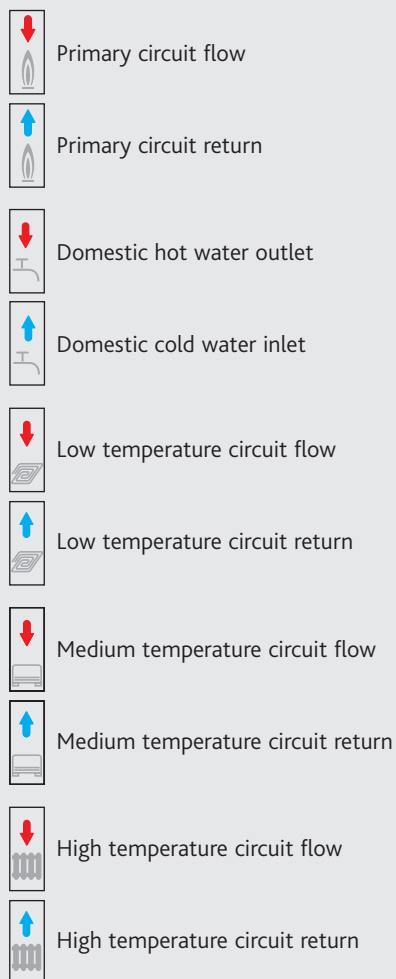

## General Information

- Please leave the manual as a reference guide for the user.
- Dispose of any packaging in an appropriate manner, most of which can be recycled.
- In this Installation, Operation and Maintenance guide we have endeavoured to make the information as accurate as possible.

We cannot accept any responsibility should it be found that in any respect the information is inaccurate or incomplete or becomes so as a result of further developments or changes to the products.

## Material

Components:	brass BS EN 12165 CW617N
Pipes:	stainless steel
Frame:	RAL 9010 sprayed steel
Exchanger:	brazed stainless steel

## Insulation

Protective shell cover:	EPP
Density:	45 kg/m <sup>3</sup>
Working temperature range:	3 to 90°C
Thermal conductivity:	0.04 W/mK

# SATK22 heat interface unit

## Dimensions

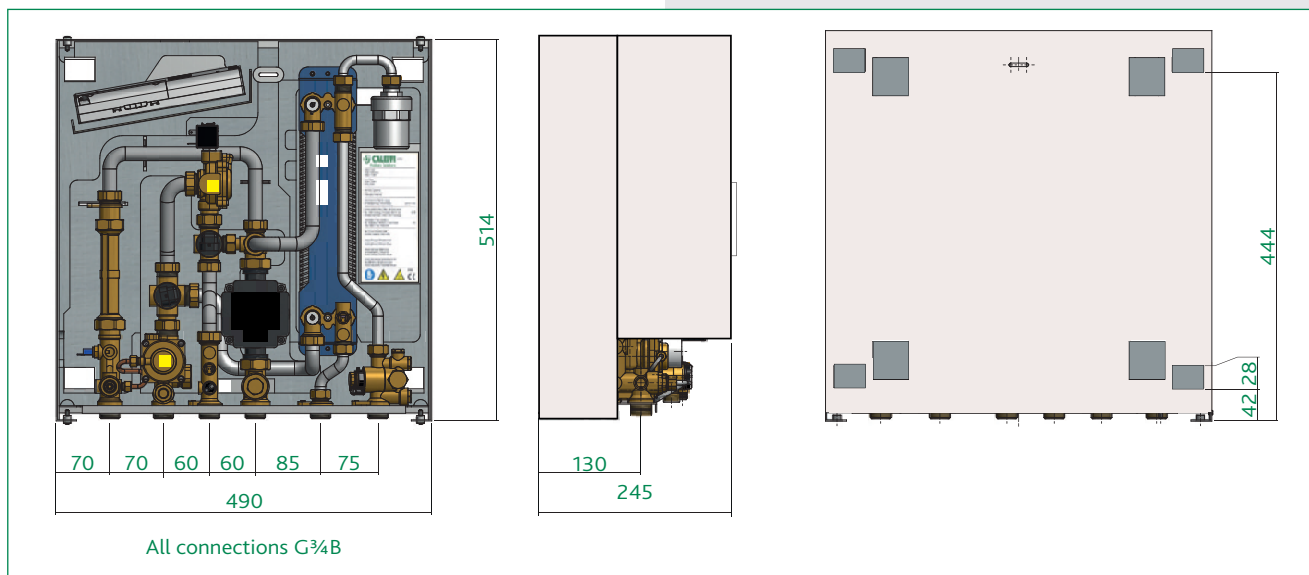

## Connections

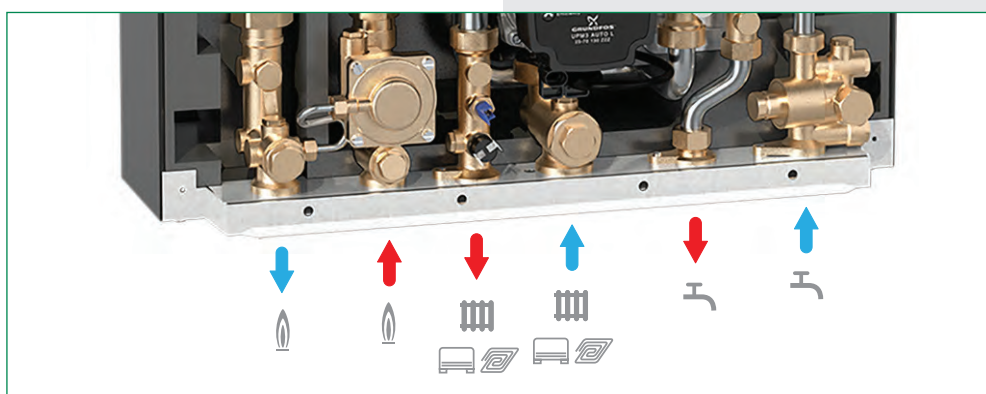

## Technical Specification

Medium:	Water
Max. percentage of glycol:	30%
Max. temperature:	90°C
Max. static working pressure:	Primary: 10 bar
	Secondary: 10 bar
	Domestic hot water: 10 bar
Primary circuit Nominal flow rate:	1.2 m <sup>3</sup> /h
Nominal pressure loss on primary circuit:	0.5 bar
Max. differential pressure:	6 bar
Domestic water circuit max. flow rate:	24 l/min (0.4 l/s)
Min. flow rate to activate domestic flow sensor:	2.0 l/min $\pm$ 0.3
Power supply:	230 V (ac) $\pm$ 10% 50 Hz
Max. power consumption:	80 W
	SATK2230 20W
Protection class:	IP 40
Pump:	UPM3 15-70
Actuator:	stepper 24 V
Probes:	NTC 10 k $\Omega$
Safety relief valve setting:	3 bar
Safety thermostat - STK2210:	55°C $\pm$ 3

# SATK22 heat interface unit

## Components - SATK2210 (LOW temperature)

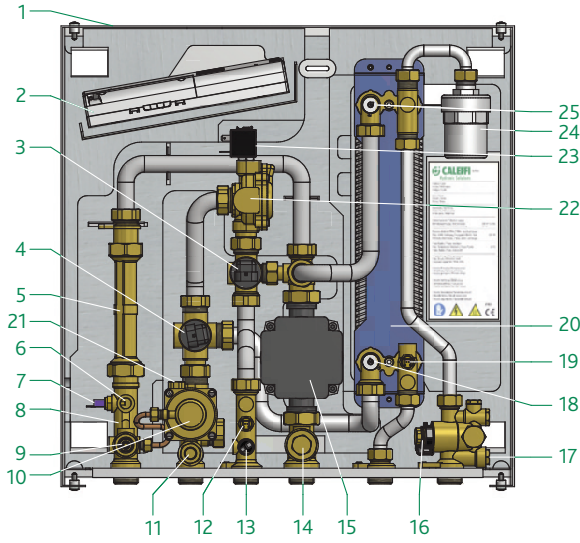

## Components - SATK2220 (MEDIUM temperature)

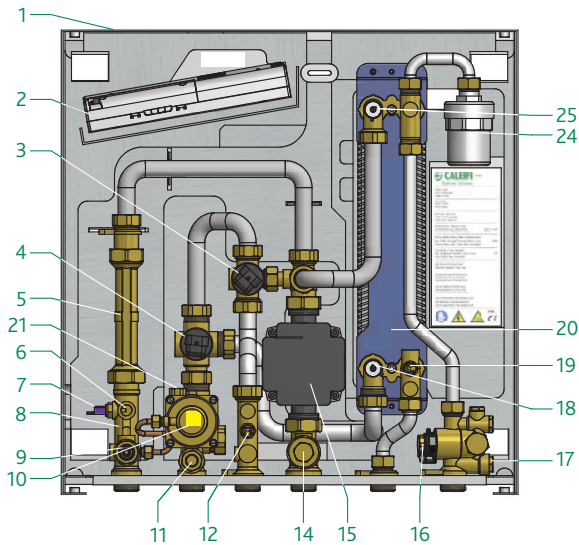

## Components - SATK2210 & SATK2220

Item	Component
1	Frame
2	Electronic regulator
3	2-way modulating valve - heating
4	2-way modulating valve - DHW
5	130 mm space for heat meter
6	¼" F pressure port
7	Return temperature probe
8	Connection for M10 x 1 heat meter return probe
9	Primary drain cock
10	Differential pressure control valve
11	Mesh strainer + ¼" F pressure port
12	Heating flow temperature probe
13*	Safety thermostat
14	Secondary drain cock + mesh strainer
15	Pump
16	Flow meter (turbine + sensor)
17	Mesh strainer
18	Heating exchanger primary drain
19	DHW temperature probe
20	DHW heat exchanger
21	Connection for M10 x 1 heat meter flow probe
22*	Thermal safety solenoid valve (normally closed)
23*	Thermal safety valve actuator
24	Water hammer arrester
25	Heat exchanger primary circuit air vent

\*only included in SATK2210

## Schematic Diagram SATK2210 and SATK2220

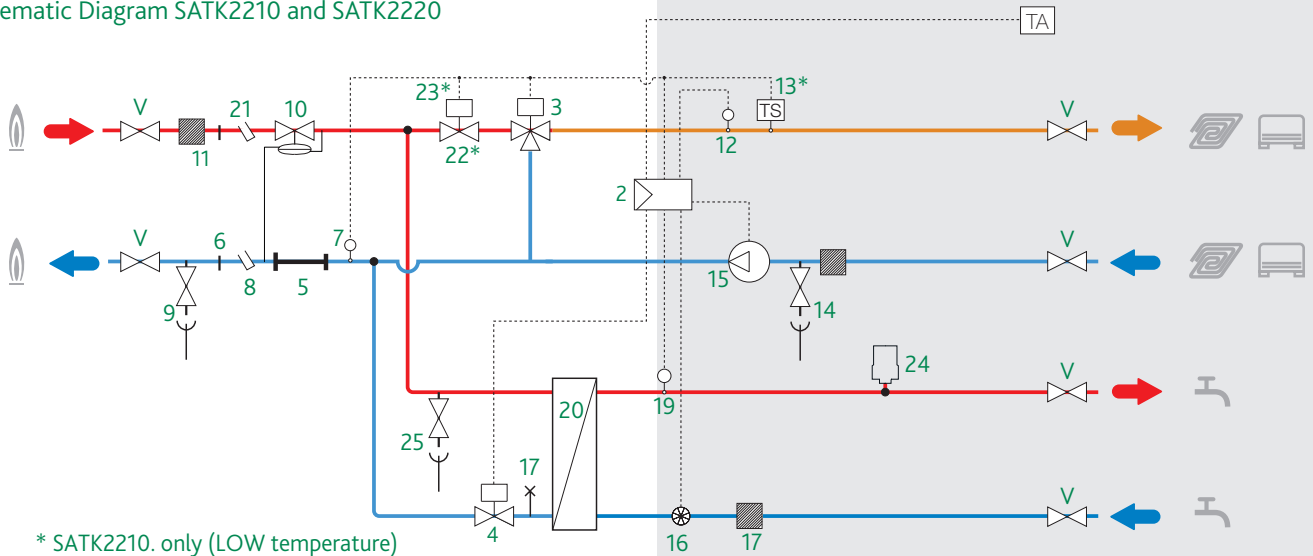

\* SATK2210. only (LOW temperature)

# SATK22 heat interface unit

## Components - SATK2230 (HIGH temperature)

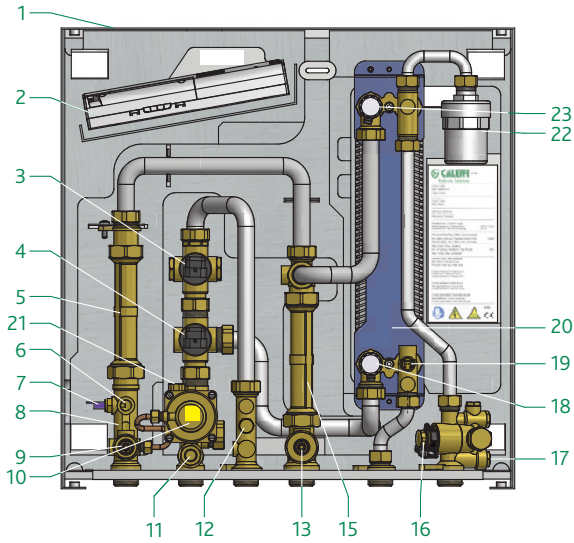

## Components - SATK2240 (HIGH temperature with pump)

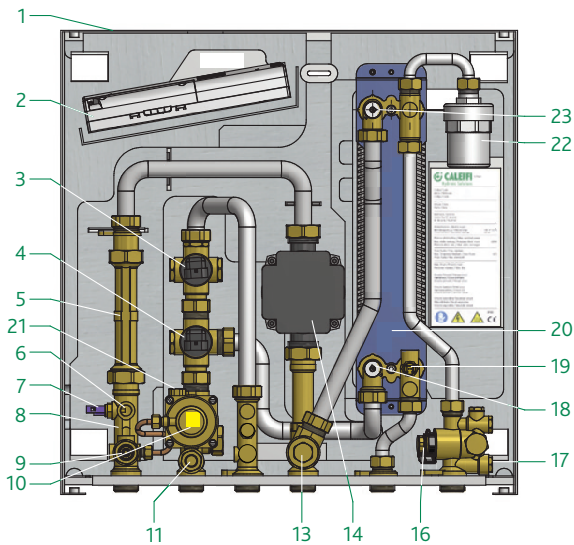

## Components - SATK2230 & SATK2240

Item	Component
1	Frame
2	Electronic regulator
3	2-way modulating valve - heating
4	2-way modulating valve - DHW
5	130 mm space for heat meter
6	1/4" F pressure port
7	Return temperature probe
8	Connection for M10 x 1 heat meter return probe
9	Primary drain cock
10	Differential pressure control valve
11	Mesh strainer + 1/4" F pressure port
12*	1/8" connection for DPCV code 789122
13	Secondary drain cock + mesh strainer
14#	Pump
15*	Spool piece
16	Flow meter (turbine + sensor)
17	Mesh strainer
18	Heating exchanger primary drain
19	DHW temperature probe
20	DHW heat exchanger
21	Connection for M10 x 1 heat meter flow probe
22	Water hammer arrester
23	Heat exchanger primary circuit air vent

\*only included in SATK2230

#only included in SATK2240

## Schematic Diagram SATK2230 and SATK2240

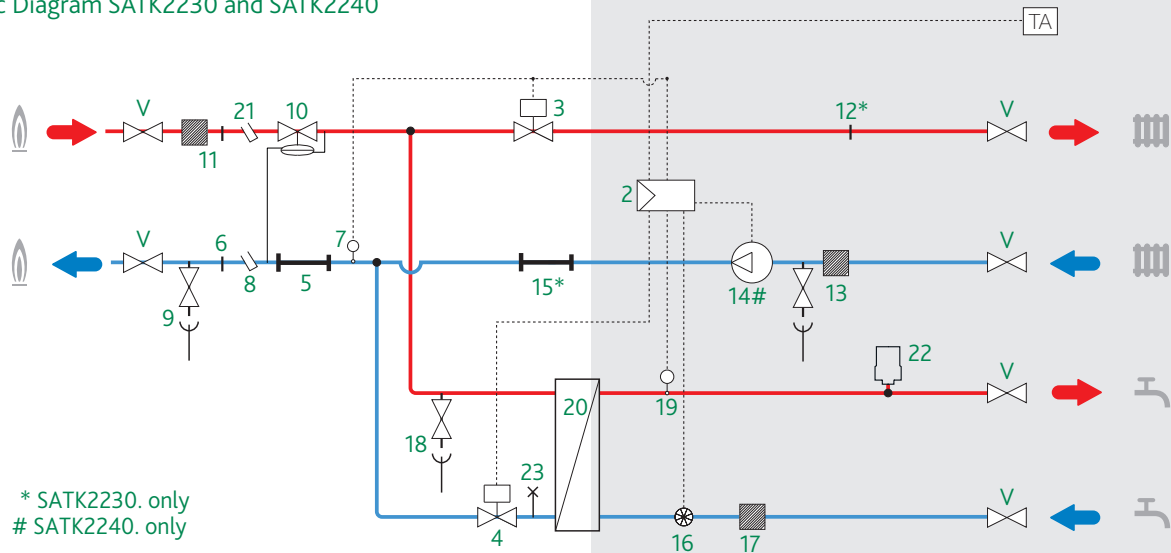

\* SATK2230. only  
# SATK2240. only

# SATK22 heat interface unit

## Installation

The SATK22 HIU is designed for installation in a sheltered domestic environment (or similar), therefore it cannot be installed or used outdoors, i.e. in areas directly exposed to the weather. Outdoor installation may cause malfunctioning and hazards.

If the appliance is enclosed inside or between cabinets, sufficient space must be provided for routine maintenance procedures.

It is **NOT** recommended to place electrical devices underneath the HIU, as they may become damaged in the event of leaks occurring at the hydraulic fittings. If this advice is not heeded, the manufacturer cannot be held responsible for any resulting damage.

In the event of a malfunction, fault or incorrect operation, the appliance should be de-activated; contact a qualified technician for assistance.

Before installation, it is recommended to carry out a thorough flushing of all the pipe work in order to remove any debris or impurities that could prevent the correct operation of the HIU.

In order to facilitate these operations a manual bypass flushing valve is available (Code 789110).

### NOTE:

When the first fix bracket is not used we recommend installing manual shut-off valves, especially on the connections to the primary line, thus allowing any necessary maintenance work to be carried out without having to empty the centralised system.

## Hydraulic connections - reversibility

Installation of the SATK22 heat interface unit is reversible (top down) **with the exception of the LOW temperature Unit SATK2210**. Installation in the two positions is possible with or without the first fix bracket Code 789023.

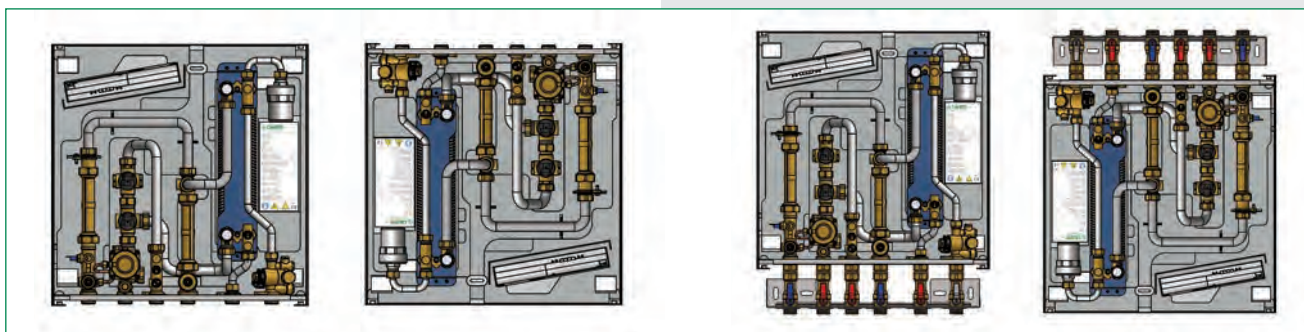

## Installation with Mounting Bracket

Ensure the wall is structurally suitable for mounting the HIU, follow the instruction below.

- Using the mounting bracket as a template mark the position of the holes required to secure the HIU to the wall. Ensure the mounting bracket is horizontal.
- Hang the HIU onto the wall bracket and secure to the wall using the fixing holes provided.
- Mark the position of the hydraulic connections

Check the measurements again and based on the above connection diagram and the dimensions shown on page 3, proceed with the installation of the following lines:

- 1 connection to the central system line
- 2 heating circuit connection
- 3 domestic water circuit connection

### NOTE:

We recommend installing manual shut-off valves, especially on the connections to the primary lines, thus allowing any necessary maintenance work to be carried out without having to empty the centralised system.

Before installation, it is recommended to carry out thorough flushing of all the pipes of the system in order to remove any residue or debris that could endanger correct operation of the HIU.

In order to facilitate these operations a manual bypass flushing valve is available (code 789110).

# SATK22 heat interface unit

## Installation with mounting bracket

### Connections at the bottom

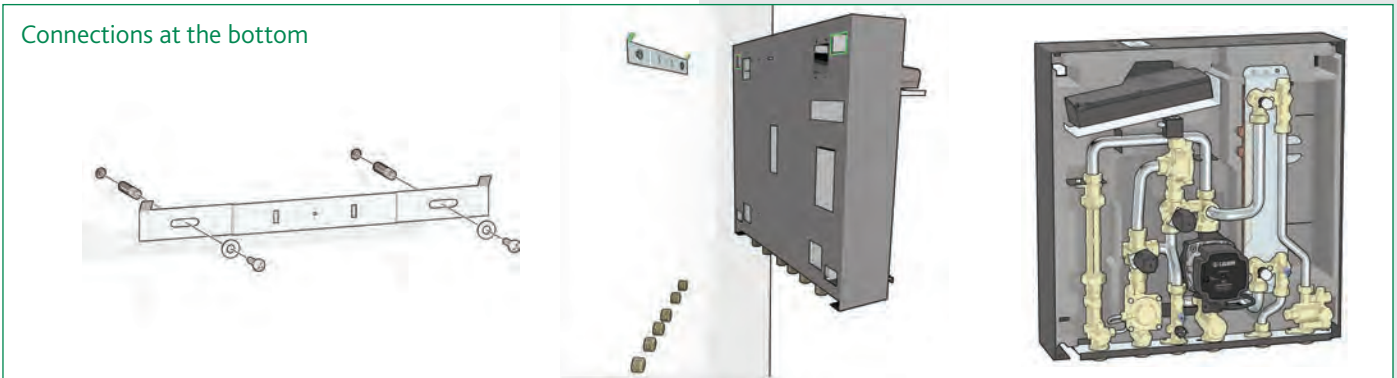

### Connections at the top

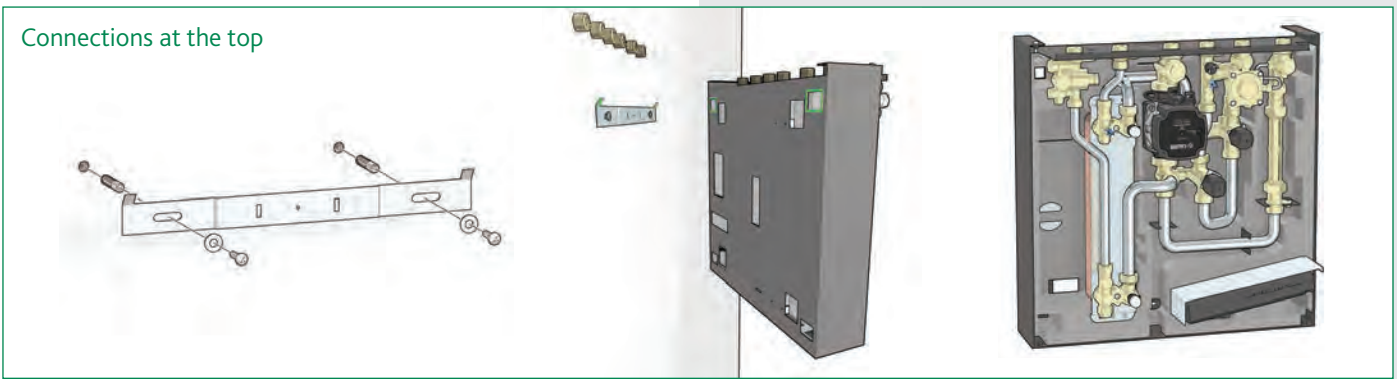

## Installation with mounting bracket and first fix bracket

Ensure the wall is structurally suitable for mounting the HIU, follow this instruction below.

- Using the mounting bracket as a template mark the position of the holes required to secure the HIU to the wall. Ensure the mounting bracket is horizontal.

In order to facilitate these operations a manual bypass flushing valve is available (code 789110).

### Connections at the bottom

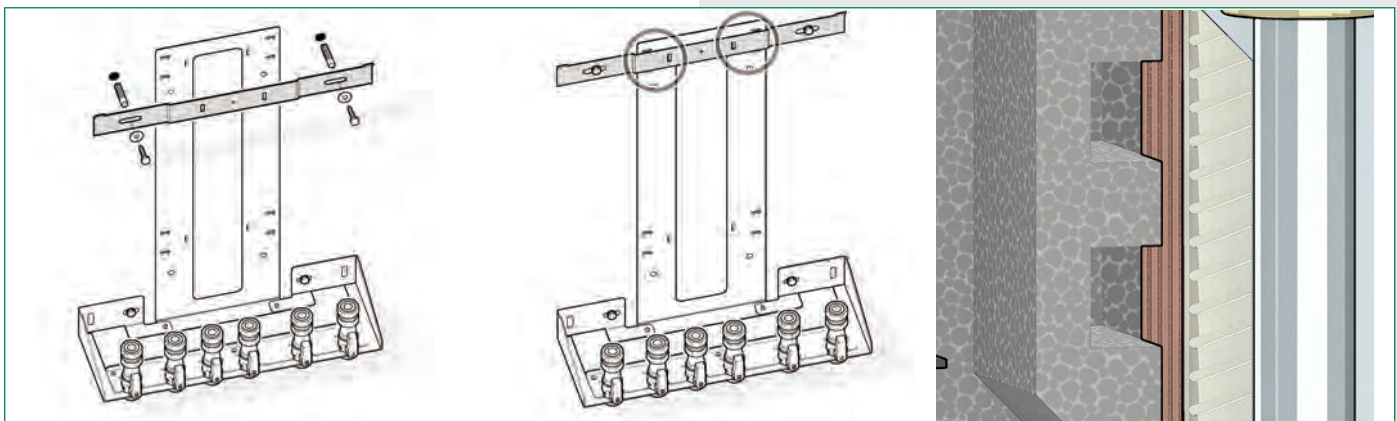



# SATK22 heat interface unit

## Connections at the top

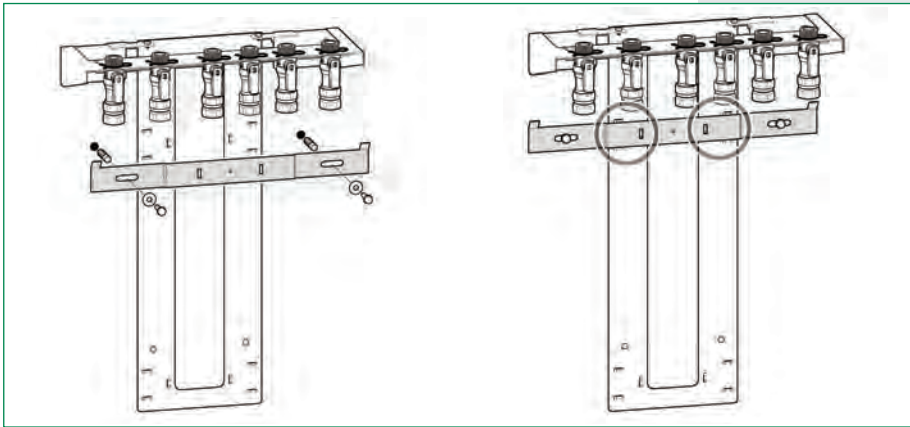

### NOTE:

When installing with the connections at the bottom secure with safety screws as shown.

Install the SATK22 as shown and using sealing washers connect the HIU to the valves on the first fix bracket.

## Hydraulic connections

Based on the dimensions and connection diagram on page 3.

- Connection to the central primary heating system.
- Connect to the apartment heating system.
- Connect to the domestic hot water system (DHW).

## Heat meter installation

The HIU is designed to house a compact heat meter (with incorporated return probe) with 1" threaded connections and length of 130 mm.

Before carrying out any maintenance, repair or part replacement work, proceed as follows:

- Switch off the electric supply
- Remove the cover
- Close the shut-off valves
- Drain the HIU using the drain cocks provided
- Remove the spool piece (A)
- Remove the cap (B)
- Install the flow meter on the return pipe. To tighten the nuts apply maximum tightening torque of 25 Nm, taking account of the recommendations of the heat meter manufacturer.
- Install the flow probe in the M10 pocket (B).

Please refer to the heat meter technical data sheets for further information.

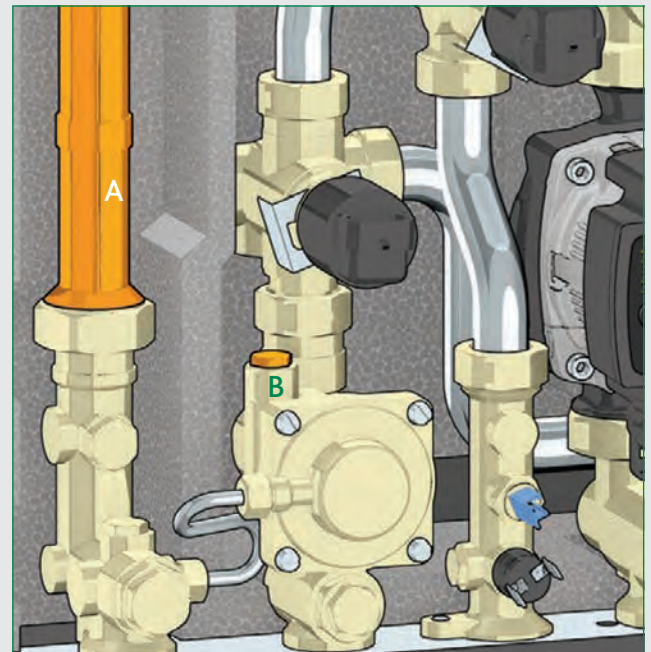

## Electrical Installation

### Connecting to the electricity supply

The HIU is supplied with an electric supply cable which is not fitted with a plug.

The appliance should be electrically connected to a 230 V (ac) single-phase + earth mains supply using the three-wire cable marked with the label as specified below, observing the LIVE (L) - NEUTRAL (N) polarities and the earth connection. This line must be connected to an On/OFF switch.

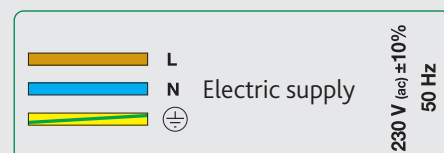

## Electrical Installation Continued

### Connecting to the electricity supply

To extend the cable if necessary, use a flexible cable suitable for kitchen and heating appliances and for home, kitchen and office installations, also in humid environments subject to medium levels of mechanical stress (e.g. H05V2V2-F: Uo/U 300/500 V). Cable minimum cross-section 3 x 0.75 mm<sup>2</sup>.

Make sure that the electrical system can withstand the maximum power consumption of the HIU, with particular emphasis on the cross-section of the wires.

If you have any doubts, contact a qualified technician to request a thorough check of the electrical system.

Electrical safety of the appliance is only achieved when it is correctly connected to an effective earthing system, constructed as specified in current safety regulations. This is a compulsory safety requirement. Observe the applicable regulations in force in the country of installation.

Use the cable pathway provided, as shown in figure 1.

### Optional electrical connections

The electronic circuit board has a door on the front providing access to terminal boards for optional wiring (see chapter "Electronic Circuit Board" on page 22).

The connections in question are all low voltage or potential-free.

Any wiring must be directed toward the exterior of the HIU, using the pathways provided in the insulation and on the frame (the one that is not used for routing the electric supply cable, see figure 2).

All these lines can be routed through a single dedicated raceway, separate from the 230 V electric cable one and anyway separate from any other live cables.

### Remote user interface connection

The HIU user interface has the dual function of control device and room thermostat.

The remote user interface can be installed on cover of the HIU or in the room in a position where the temperature measurements will be of significance for control of the heating function (in a heated room in a position where the temperature read by the thermostat is not affected by any nearby heat sources).

### Installation on the cover of the HIU

If the remote user interface is fitted in the dedicated location on the cover of the HIU, the thermostat function must be disabled (in this case an external thermostat must be used, as described in the next section).

The adjacent figures show how to install the remote control unit:

- Feed the cable from the regulator through the hole in the cover (3).
- Feed the cable from the regulator through the rear of the interface (4).
- Connect the two wires to the terminals on the electronic circuit board (the cable is not polarised) (5).

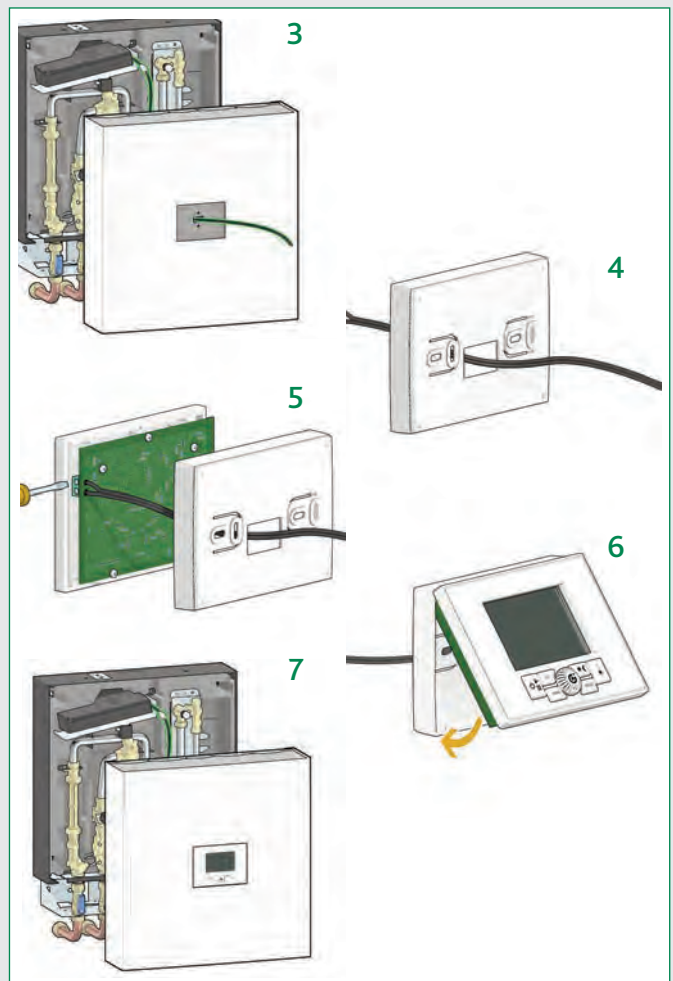
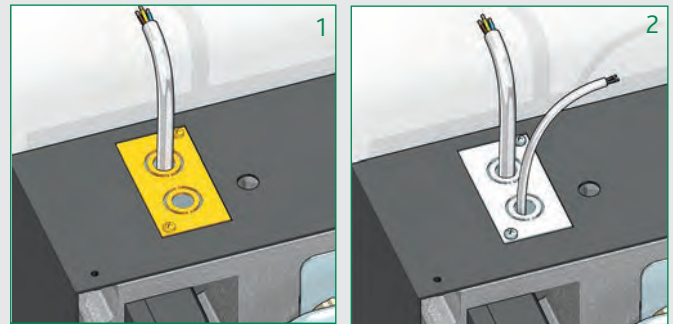

- Close the remote user interface and position it in its housing on the cover (6), (7); if necessary, secure the user interface from inside the cover by means of self tapping screws and washers.
- Plug in the connector (8).

The thermostat function is enabled by default (refer to the remote control user manual for disabling it).

# SATK22 heat interface unit

## Installation in the room

Use the cable outlet provided for connecting the remote user interface to the electronic circuit board.

The chrono-thermostat function has to be enabled through the remote control.

Refer to the dedicated user manual for the procedure.

## Use of an external room thermostat

An external room thermostat, if installed, must be with potential-free contact.

The external thermostat has to be connected to the terminals "RT" shown in the adjacent figure.

The terminals can be accessed by removing the door on the HIU electronic regulator (see page 22).

In case the thermostat function of the remote user interface is enabled, any external thermostat will work in parallel (management of different temperature zones).

Alternatively, when the thermostat function of the remote user interface is disabled, the interface can be used to define the hourly programming of the space heating function for all thermostats connected to the terminal "RT".

Refer to the user interface dedicated manual.

## Commissioning

### Filling the central heating system

Open the shut-off valves on the connections to the primary heating system and the central heating system, proceed with charging the system to the design pressure.

Once these procedures are complete, vent the system and check the pressure again (repeat the filling process if necessary)

**N.B.** during the procedures for venting/draining the system use suitable measures to avoid the risk of any liquid dripping onto the electronic components.

Once these procedures are complete, vent the system and check its pressure again (repeat the filling process if necessary)

**N.B.** during the procedures for venting/draining the system use suitable measures to avoid the risk of any liquid dripping onto the electronic components.

### System start-up

Before starting the HIU, visually check the hydraulic connections for any signs of leakage and all the electric connections.

After finishing the check, switch-on the electric supply to the HIU and check for the presence of any error signal.

If there are any, eliminate the fault indicated (see page 26) and proceed with setting the set point of the domestic water and heating cycles, programming the remote user interface according to the desired temperatures and times, and checking the operating cycles.

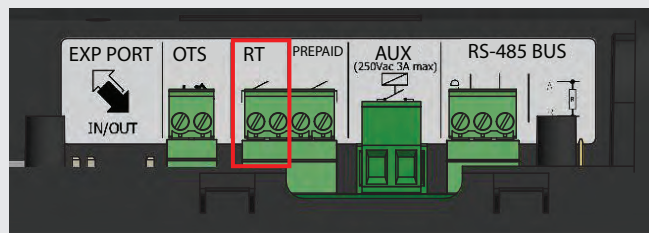

## Commissioning Continued

### Fitting the cover

Fit the cover on the HIU by inserting the pins (A) in the locations provided (B).

Secure the cover by tightening the 4 screws provided (C).

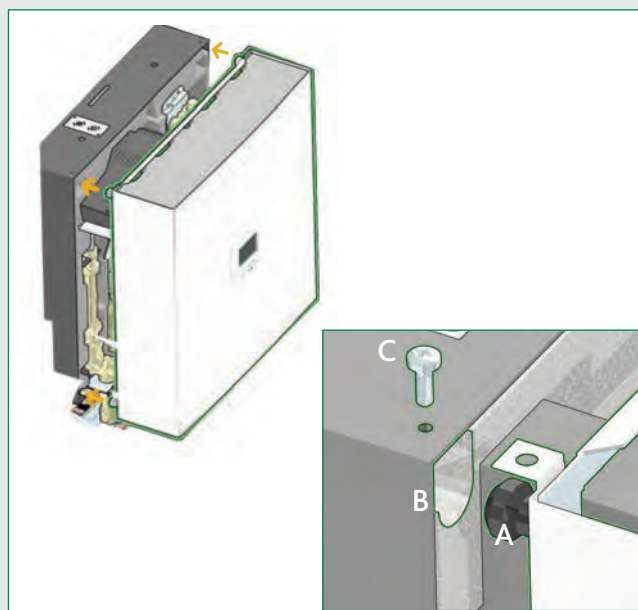

## Remote User Interface Quick Guide

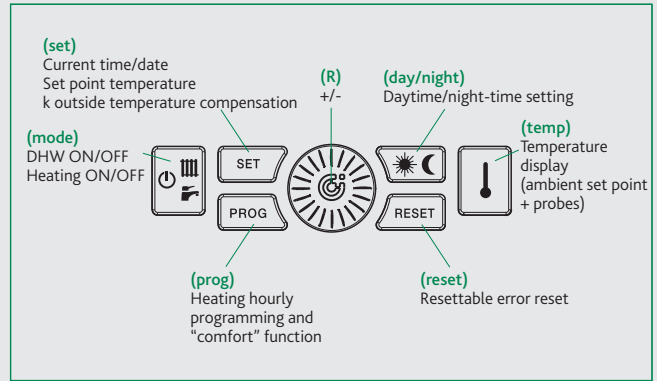
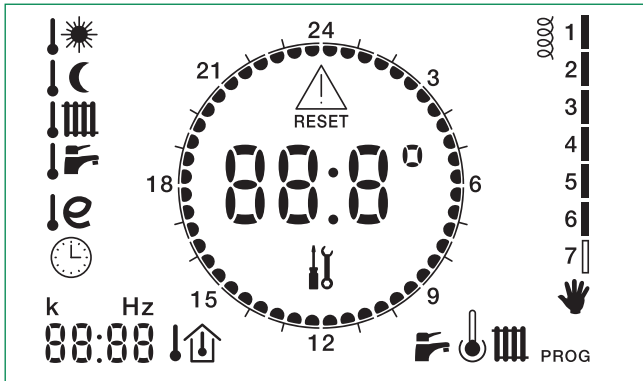

The digits in the centre of the display show the current ambient temperature, if the thermostat function is enabled.

In case the latter is disabled, the digits show DHW temperature and heating flow temperature when the HIU is in operation, "--." when in stand-by.

### Selecting the active services

(DHW/heating) Press the <mode> key repeatedly to scroll through the various available operating modes.

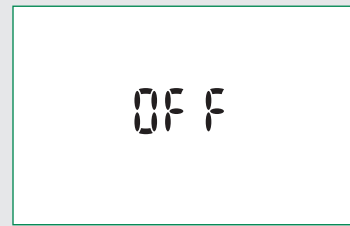

OFF

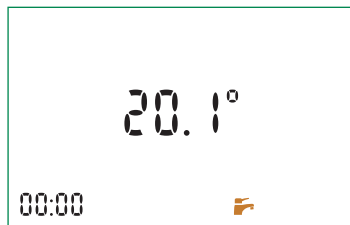

DHW only ("summer mode")



Heating + DHW ("winter mode")

### Selecting set points, current time and comfort function

Press the <set> key repeatedly to set the current time, set point temperatures and comfort function. The value can be modified by turning knob <R>.

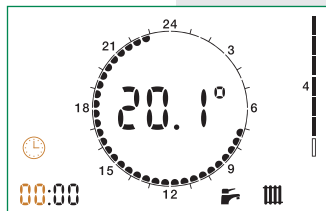

Current hours, minutes and day

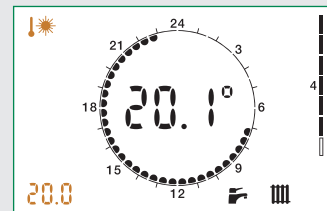

Daytime ambient temperature (\*)

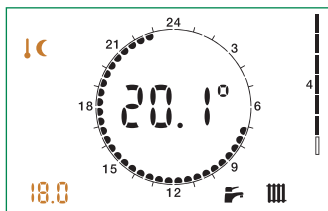

Night-time ambient temperature (\*)

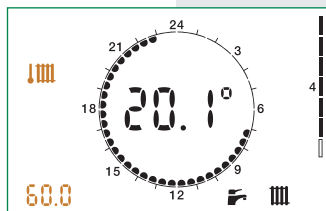

Heating flow temperature (SATK2210 & SATK2220)

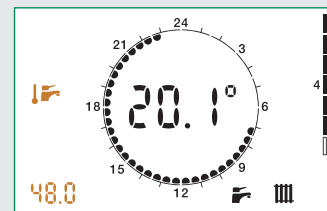

DHW temperature

## Remote User Interface Quick Guide



Primary limit/set return temperature in Heating mode (\*\*)

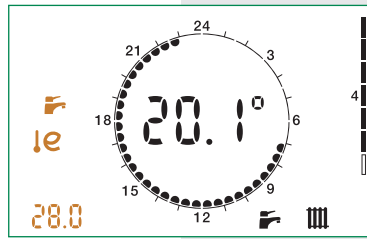

Primary limit/set return temperature in DHW mode (\*\*)

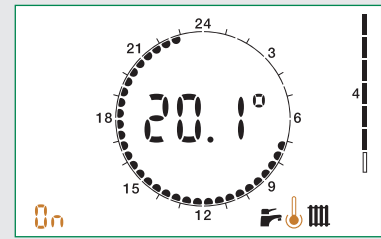

Comfort function (ON/OFF or according to weekly program)

(\*) if the thermostat function of the remote user interface is enabled.

(\*\*) if these set points cannot be changed you must set parameter t07 to value 0 in the technical menu (see "access to technical menu" below). Parameter t07= 1 "freezes" the operating set points to prevent inadvertent modifications by the user.

### Temperature display

Press the <temp> key repeatedly to display the current ambient temperature set point and the temperature values read by the three probes of the HIU.

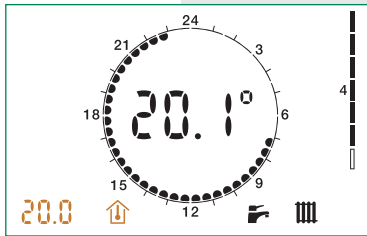

Current ambient temperature set point (\*)

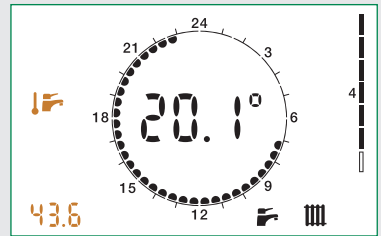

DHW probe temperature

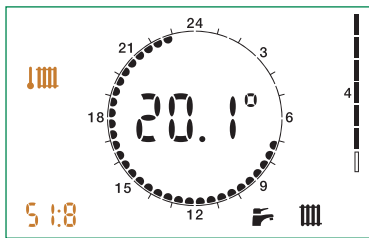

Heating flow probe temperature #

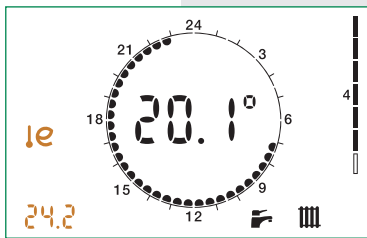

Primary return probe temperature

# SATK2210 & SATK2220

(\*) if the thermostat function of the remote user interface is enabled.

### Access to technical menu

Press the <mode> key repeatedly to set the HIU to OFF status.

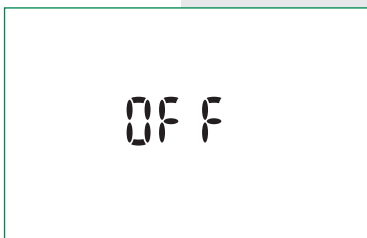

Heat interface unit in OFF mode

Hold the <set>, <day/night> and <temp> keys pressed together for 10 seconds.

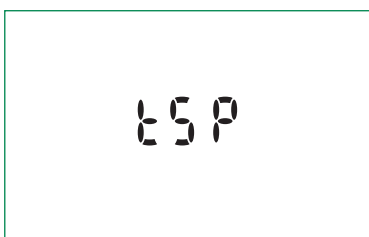

Access to the technical parameters

Once "TSP" appears on the display, confirm access by pressing the central knob <R>. By rotating knob <R> it is possible to scroll through the various parameters, which can then be edited, pressing and rotating knob <R>.

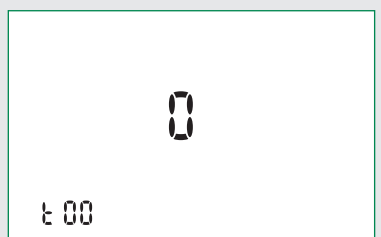

Technical parameter t00

To exit the menu, wait a few seconds or press the <reset> key. Re-enable the required services using the <mode> key.

Refer to the remote control user manual for the hourly programming of space heating and DHW comfort function.

## Heating Function

### Heating flow temperature setting (SATK2210. and SATK2220.)

To set the flow temperature press the <SET> key until the symbol in the red circle appears. Use the <R> knob to change the value.

The flow temperature range is:

25–45°C for SATK2210. (LOW temperature)

45–75°C for SATK22203. (MEDIUM temperature)

### Default Setting: set point regulation

(technical parameter t01 = 0)

When heating cycle activation is requested by the room thermostat, the circulation pump is powered while the mixing valve is opened gradually until the set point temperature is reached. |

In the high temperature models (SATK2230 - SATK2240) the valve is opened up to the maximum allowed (see Primary Flow Rate Limitation on page 17)."

The circulation pump is stopped and the modulating valve is closed at the end of the heating cycle. The heating cycle ON condition is indicated by the blinking |||| symbol.

### OPTIONAL SETTING: primary return temperature limit (technical parameter t01 = 1)

When heating cycle activation is requested by the room thermostat, the circulation pump is powered while the mixing valve is opened gradually until the set point temperature is reached (in SATK2230 and SATK2240 the valve is open fully, up to the maximum allowed), if the return temperature is lower than or equal to the set limit value.

In case this condition is not met, in HIUs with control of the flow temp. (SATK2210 and SATK2220) the flow temperature is reduced (by a maximum of 15°C in SATK2220, and maximum 3°C in SATK2210, in order to bring return temperature within the limit values.

In SATK2230 and SATK2204 a reduction of the heating flow rate is operated. When the flow temperature/flow rate must be reduced in order to limit return, the e icon appears on the display.

To set the flow temperature press the <SET> button until the symbol in the green circle appears. Use the <R> knob to change the value (\*). The primary return limit temperature range is:

15–42°C for SATK2210 - LOW temperature

30–70°C for SATK2220 - MEDIUM temperature

### Heating flow/ primary return limit temperature setting

To set the flow temperature press the <SET> key until the symbol in the red circle appears; for the return temperature limit press the key until the symbols in the green circle are displayed. Use the <R> knob to change the value (\*).

The flow temperature range is:

25–45°C for SATK2210 - LOW temperature

45–75°C for SATK2220 - in MEDIUM temperature

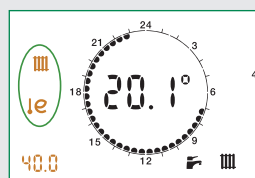
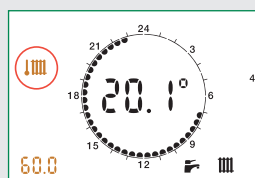
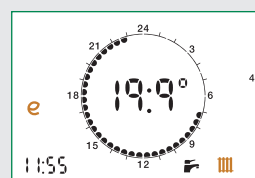

## Heating Function

**OPTIONAL SETTING: modulating temperature regulation with compensated set point (technical parameter t01= 2) (SATK2210 & SATK2220)**

When the function is enabled, the flow temperature is modified ( $\pm 10^{\circ}\text{C}$  with respect to the set point for HIU in HIGH temperature,  $\pm 3^{\circ}\text{C}$  if in LOW temperature) according to the temperature detected by the return probe in order to maintain this latter temperature value constant.

This keeps the actual thermal output of the slab under control, and consequently also the ambient thermal load. The thermal response time of the system is thus minimised.

This feature should not be used in combination with thermostatic radiator valves.

When the function is enabled the display shows the symbol  $\uparrow$

**OPTIONAL SETTING: weather compensation (technical parameter t01 = 3)**

When the function is enabled, the flow temperature is calculated based on the temperature detected by the outside probe (optional), in accordance with the curve shown below.

The “k” coefficient can be changed by pressing <SET> button until the related setting appears.

The display shows the symbol  $\uparrow$  .

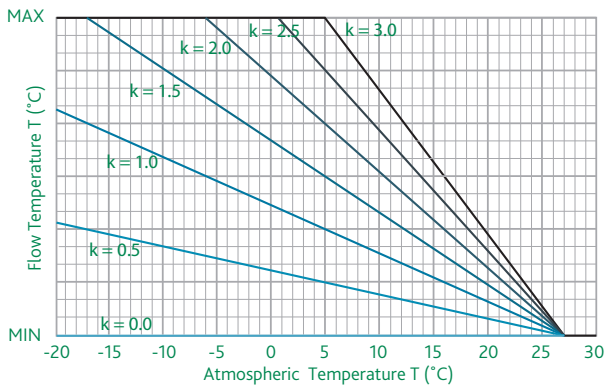

MAX is the set temperature value  
MIN is  $45^{\circ}\text{C}$  for HIGH temp. HIUs,  $25^{\circ}\text{C}$  for LOW temp. ones.

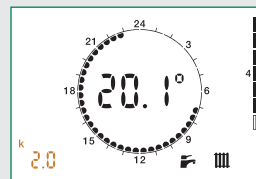
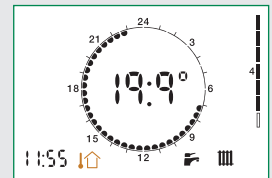
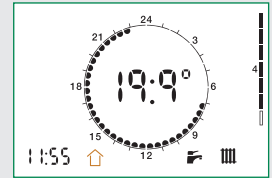

(\* if these set points cannot be changed you must set parameter t07 to value 0 in the technical menu (see “access to technical menu” below). Parameter t07 = 1 “freezes” the operating set points to prevent inadvertent modifications by the user.

## DHW Function

The DHW cycle always takes priority over the heating cycle.

**DEFAULT SETTING: fixed DHW set point (parameter t06=0)**  
When DHW cycle activation is requested, due to DHW tapping by the user (detected by the domestic water flow meter), the regulator modulates the valve opening in order to adjust the temperature detected by the domestic water probe to the selected set point value. When tapping ends, the modulating valve is fully closed.

The DHW cycle ON condition is indicated by the blinking  symbol.

**OPTIONAL SETTING: primary return temperature limit (technical parameter t06 = 1)**

When DHW cycle activation is requested, due to DHW tapping by the user (detected by the domestic water flow meter), the regulator modulates the valve opening in order to adjust the temperature detected by the domestic water probe to the DHW set point value if the return temperature is less than or equal to the set limit. If this condition is not met, the flow temperature is reduced (by a maximum of 7°C down to a temperature that can be no less than 40°C), in order to bring return temperature within the limit values.

Due to the activation of the return temperature limitation function, the DHW temperature can be lower than the set value.

## DHW/primary return limit temperature setting

To set the DHW temperature press the <SET> key until the symbol in the red circle appears; for the return temperature limit press the key until the symbols in the green circle are displayed. Use the <R> knob to change the value (\*).

The range of possible DHW temperatures is 42–60°C, while the range of possible return temperatures is 15–45°C.

(\* if these set points cannot be changed you must set parameter t07 to value 0 in the technical menu (see “access to technical menu” below). Parameter t07 = 1 “freezes” the operating set points to prevent inadvertent modifications by the user.

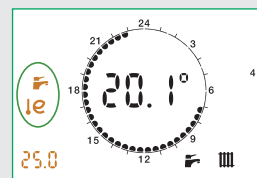
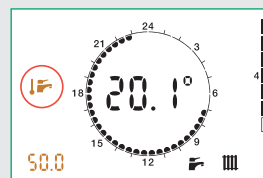
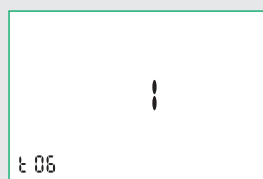
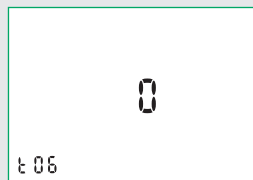



## DHW Comfort Function - Pre-heat, DHW Re-circulation

The comfort function can be, alternatively, preheating of the DHW plate heat exchanger or management of DHW recirculation. They are enabled by setting to ON or PROG the comfort function (see page 12).

**DEFAULT SETTING: DHW exchanger preheating function (parameter t02 = 0)** During periods when the domestic water cycle is not used, if the DHW probe detects a temperature 10°C below the SET value, the regulator partially opens the domestic hot water modulating valve for the time required (max. 5 min.) to bring the exchanger to the condition wherein it can assure rapid DHW production.

The active pre-heating cycle is indicated by the blinking ↓ symbol. This function is of lower priority than any domestic water or heating cycles.

**OPTIONAL SETTING: management of DHW recirculation in the apartment (parameter t02 = 1)**

In alternative to the DHW comfort function it is possible to manage DHW recirculation, using a similar logic. During periods when the domestic water cycle is not used, if the DHW probe detects a temperature 10°C below the SET value, by means of an auxiliary microswitch (see page 17), the regulator closes the circuit supplying the circulation pump (not supplied) generating a DHW cycle lasting for a pre-set amount of time. This amount of time is pre-set to 2 minutes. It can be changed by acting on parameter t09 on the technical menu (1 unit = 10 seconds).

The circulator has to be fed through the auxiliary microswitch so that the control of recirculation is carried out by the heat interface unit. DHW recirculation (t02=1) disables the other functions operating on the auxiliary microswitch described on page 17. Refer to page 17 for the electrical characteristics of the microswitch.

Both comfort functions can be enabled according to user defined weekly time programming. Refer to the remote user interface manual

## Anti-Legionella Function

**DEFAULT SETTING: anti-legionella function OFF (technical parameter t08 = 0)**

Enabling the anti-legionella function by means of technical parameter t08 = 1, in time band 3:00 - 3:30:

- the DHW set point will be temporarily increased to the maximum value (60°C) - the comfort/recirculation function will be forced ON.

As a result of the temperature rise of the set point, at time 3:00 a comfort function (either pre-heating or recirculation) will be triggered, bringing the temperature to a value close to 60°C, such as to rapidly reduce the presence of any bacteria.

During execution of the cycle, the user interface display will show the blinking ▲ symbol (refer to the adjacent figure).

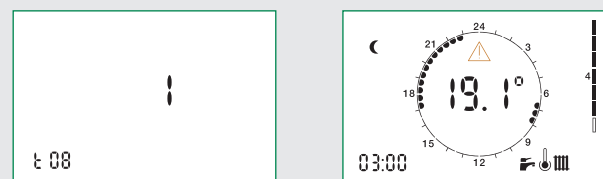
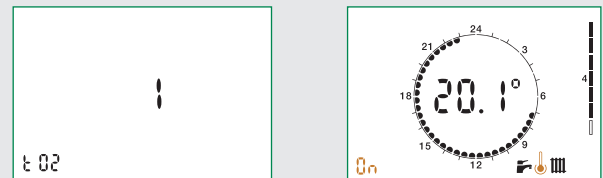
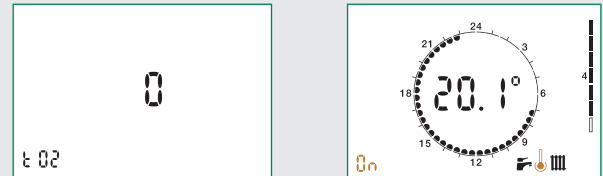

### IMPORTANT!

- Any DHW production that occurs during the time band (3:00 - 3:30) will be at 60°C.
- The cycle execution time band (3:00 - 3:30) is established in accordance with the time set on the remote control unit. Incorrect time setting will result in execution of the anti-legionella function in a different actual time band.

Due to the effect of exchanger thermal inertia, temporary DHW production at high temperature could proceed also beyond the time of 3:30.

If the function is enabled thermostatic mixing valves should be installed on the users level (washbasin/shower, etc.).

## Primary Flow Rate Limitation

Primary flow rate limitation in heating mode.

**DEFAULT SETTING:** no limitation (technical parameter t03 = 100)

During start-up of the heating cycle from cold, e.g. on change over from night-time ambient set point to the daytime set point, the HIU may demand a significantly higher primary flow rate than the design one, because of the low temperatures of the secondary medium.

This effect is far greater with high temperature systems in which, during the transient to the design operating condition, high thermal power values may be transferred from the primary circuit to the secondary circuit. This effect can be restricted by lengthening the transient, setting a limit on the maximum primary flow rate that can be withdrawn in heating mode.

The flow rate limitation is imposed by controlling the maximum opening of the primary circuit modulating valve.

The relationship between the degree of opening (%) and Kv of the circuit that connects the primary flow to the secondary flow is shown in the graphs.

Primary flow rate limitation in DHW mode.

**DEFAULT SETTING:** no limitation (technical parameter t04 = 100)

Likewise, you can establish a limit to the primary flow rate that can be tapped for instantaneous DHW production.

The flow rate limitation is imposed by controlling the maximum opening of the primary circuit modulating valve. Since latter is controlled by a differential pressure limiter, it is possible to supply direct correspondence between the opening position of the valve and the circulating flow rate (\*).

**N.B.** Any limitation must be assessed in accordance with the effective thermal characteristics of the residential unit served.

(\*) The correspondence between valve position and flow rate is indicative. Graphs obtained with pressure head upstream of the HIU = 50 kPa.

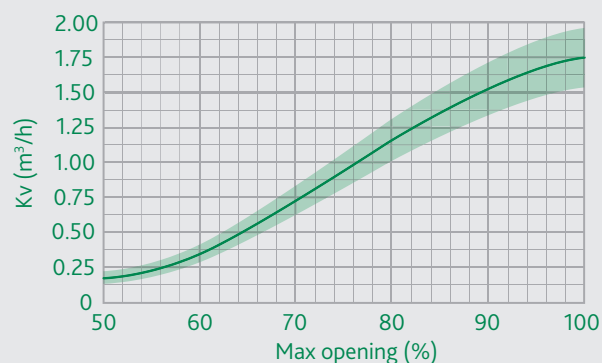

A maximum degree of opening (%) can be set via technical menu parameter t03

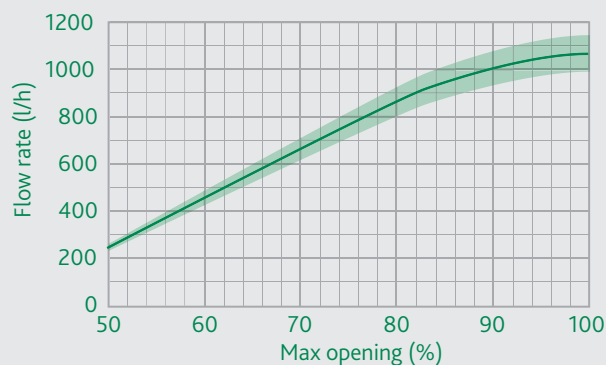

A maximum degree of opening (%) can be set via technical menu parameter t04.

## Circulator - Curves and Settings

The HIU is equipped with a Grundfos circulator model UPM3 AUTO-L 15-70.

By default, the circulator setting is with the maximum proportional head characteristic.

Pressing the front key briefly produces the sequence of LEDs corresponding to the selected hydraulic characteristic. A couple of seconds after pressing the key, the circulator again produces a sequence of LEDs showing the instantaneous power consumption:

- 1 yellow LED lit: power between 0 and 25% of  $P_{max}$ ;
- 2 yellow LEDs lit: power between 25 and 50% of  $P_{max}$ ;
- 3 yellow LEDs lit: power between 50 and 75% of  $P_{max}$ ;
- 4 yellow LEDs lit: power between 75 and 100% of  $P_{max}$ .

To change the characteristic, hold down the front key for more than two seconds and then press the same key repeatedly until reaching the required characteristic (refer to the adjacent figure).

Having identified the required characteristic (head - flow rate chart shown below) wait for about ten seconds for the setting to be accepted by the circulator, which will then revert to the sequence of LEDs showing power consumption.

A long press of the front key (>10 seconds) locks the pump setting, preventing possible incorrect modifications of the curve.

Unlocking can be done in the same way, with a long press (>10 s) of the front key.

The pump also has a self-diagnostics system to reveal any possible operating problems.

Any problem detected is shown by a sequence of LEDs:

ALARM STATUS	
	Blocked
	Supply voltage low
	Electrical error

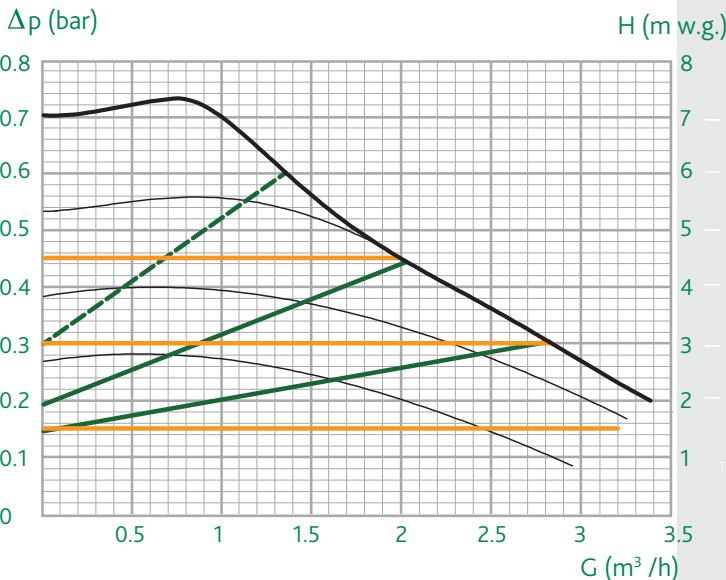
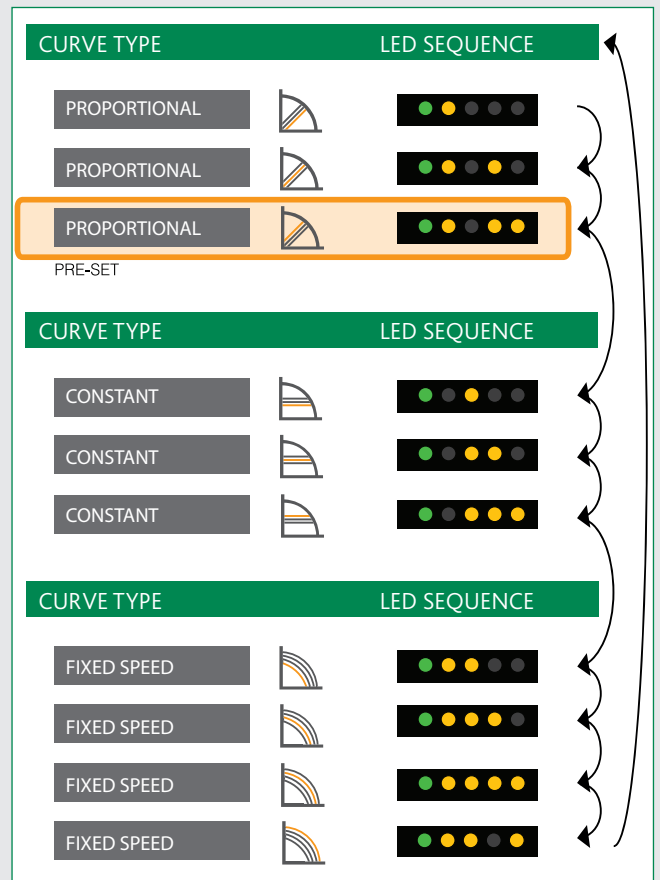
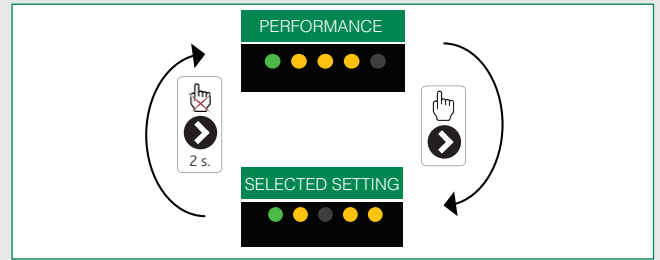

## Auxiliary Microswitch

The HIU is equipped with a contact, driven by a relay incorporated in the circuit board, the intervention logic of which can be programmed in accordance with requirements by setting technical parameter t05.

Each event linked to operation of the HIU is linked to a numerical value, according to the following table:

Events - Conditions	Value
DHW tapping in progress	1
Heating cycle in progress	2
Comfort cycle (pre-heating/recirculation) in progress	4
HIU OFF	8
Error not active	16
Error active	32

Closing of the contact on the occurrence of multiple events conditions is programmed by setting parameter t05 to a value corresponding to the sum of the single events/conditions.

We give some practical examples below:

**example 1 - Driving an external primary flow pump, normally OFF.**

The contact must be closed if any HIU function is active (DHW production, heating, pre-heating)

Parameter t05 must be set to:  $1 + 2 + 4 = 7$

**example 2 - Distinction of consumption for DHW production from total consumption (in combination with heat meter equipped with dedicated function)**

The contact must be closed both if DHW tapping is in progress and if activation of the comfort function is requested (pre-heating or recirculation).

Parameter t05 must be set to  $1 + 4 = 5$ .

Closing of the microswitch is shown on the user interface by the symbols shown alongside.

**N.B. if the DHW recirculation function is enabled with t02 = 1 (see page 16) the auxiliary microswitch intervention logic described above is not operational. In this case, the contact is used to control the recirculation pump.**

## Connection

For information on how to access the dedicated terminals, consult the "Electronic Circuit Board" section on page 22.

**N.B.:** the auxiliary microswitch can be used to drive electric loads directly, taking account of the following operating limits:

Max. voltage: 230 V ac

Max. current: 3 A

If the electric load to be controlled is not included within the parameters indicated an external relay must be interposed.

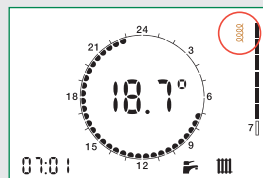
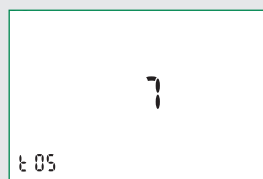

## Modbus

The HIU offers a remote connectivity solution by means an RS-485 wired network and Mod-Bus communication protocol.

On request, Altecnic will supply a map of the Mod-Bus registers and data transmission specifications so the product can be integrated in an existing BMS system.

The RS-485 communication network should be preferably constructed in compliance with the prescriptions of standard EIA RS-485.

Any other configuration of the physical layer is at the discretion of the BMS system operator, which will assume responsibility for checking the implications in terms of transmission quality.

In particular, it is essential to use a two-wire twisted cable. Compliance with this requirement becomes even more significant the more extensive the RS-485 network.

If, alternatively, a shielded wire is used, the shield must be connected solely on the master side.

As a guideline, take account of the following general prescriptions to ensure optimal transmission quality:

- use a BUS cable with impedance of around 120 Ohm;
- connect a terminal resistor, having same impedance as the cable, at each end of the RS-485 cable;
- keep the length of side branches as short as possible.

The device is configured by default to support a communication speed of 9600 baud/s with parity "none".

The communication speed can be changed via Modbus, to the following values: 2400, 4800, 9600, 19200 baud/s.

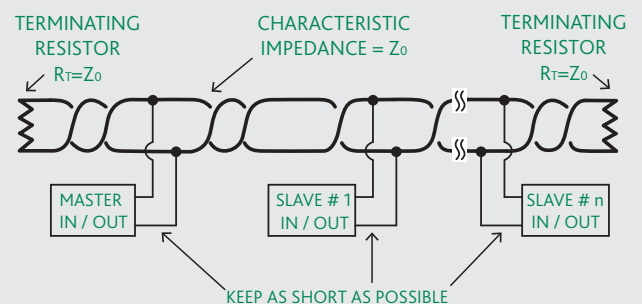
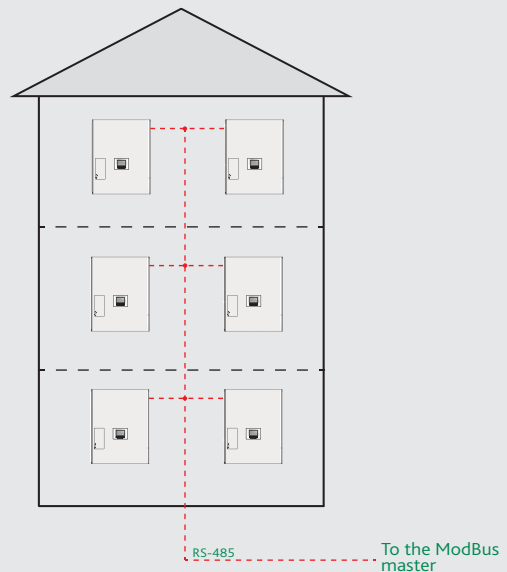

## Safety and Alarms

If the electronic circuit board detects a fault, the display shows the error code concerned and the symbol .

### Heating probe fault (SATK2210 & SATK2220)

Error code: 5



### Domestic water probe fault

Error code: 6



### Return probe fault

Error code: 15



### Return probe fault

Error code: 15



### Corrective action

Normal operating conditions are restored automatically once the faulty probe is working properly again (see page 25 - "Temperature probe replacement").

### Thermal safety solenoid valve (SATK2210)

Error code: 76

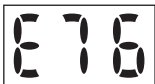

### Corrective action

Normal operating conditions are restored automatically once the faulty safety valve works properly again.

### Safety thermostat cut-out (SATK2210)

Error code: 69



HIUs configured to support low temperature heating continuously monitor the safety thermostat controlling the flow temperature.

If the safety thermostat is activated during a general cycle, the heating circulation pump immediately comes to a stop and the modulating valve is completely closed.

After the user has removed the block imposed by the safety thermostat, operation can only be re-enabled when the modulating valves are completely closed again.

This means that if a domestic water cycle is in progress, the activation of the shut-off valve will be postponed until the end of that domestic water cycle.

### Corrective action

To restore the operating mode press the manual **RESET** button.



### Heat interface unit disabled

Error code: 80

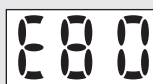

The HIU is disabled due to an incorrect connection on the circuit board front terminals or due to an input from an external device indicating zero credit.

### Corrective action

Check the electrical connections or, in the case of zero credit, top-up the external device/contact the service supplier.

# SATK22 heat interface unit

## Electronic Circuit Board

### Optional connections

The electronic circuit board has a front door (shown in the adjacent figure) that provides access to the connectors related to HIU optional functions.

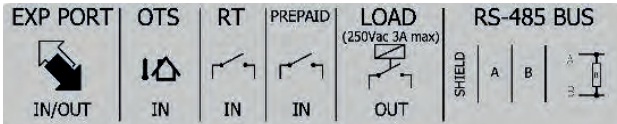

N.B. before working on the circuit board you must disconnect the electric supply to the HIU.

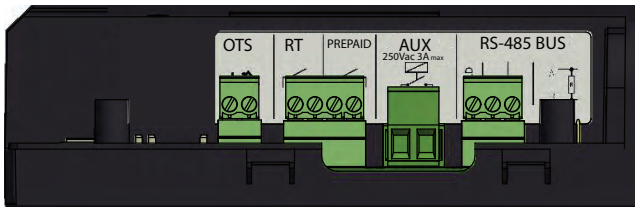

All the terminals are mounted on removable connectors to facilitate wiring operations.

The following services are accessible:

- External probe for outside compensated temperature regulation

Use optional probe code 789833

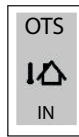

- External room thermostat

**IMPORTANT!** The connection is volt free. Do not connect powered contacts.



- Interface with pre-paid services

In case the HIU has to be interfaced with controllers PREPAID managing the heating and DHW production services by means of "pre-paid" type logic.

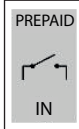

The HIU interprets an open contact as "credit available". Closing the contact disables the heating and DHW production services. When this condition occurs the user interface display shows error "E80".

**IMPORTANT!** The connection is volt free.

Do not connect powered contacts.

If the controller that manages the pre-paid service supplies a powered contact, a relay must be interposed.

### Auxiliary contact

To implement the functions described on page 19 and for the connection of the DHW recirculation pump (see page 16)

**IMPORTANT!** Max. voltage 230 V ac, max. current 3 A.

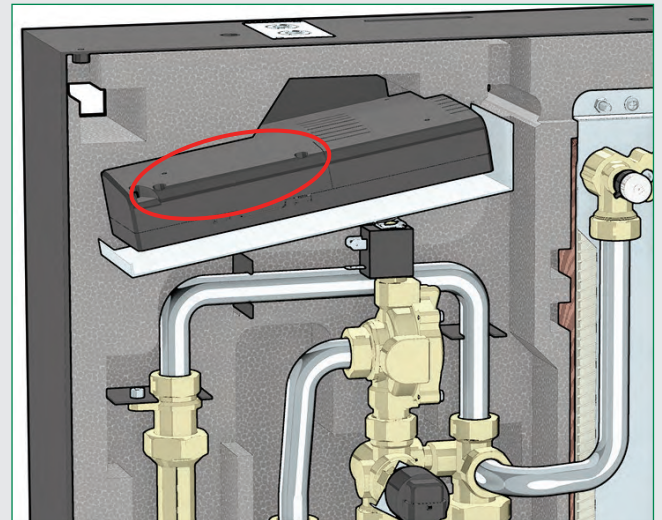

### • Mod-Bus

RS-485 port to connect HIU to a wired network for Mod-Bus communication.

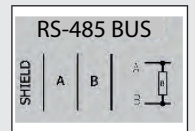

### Connector colours

If the connectors of actuators and temperature probes are disconnected during special maintenance work, comply with the following instructions to reconnect them:

DHW probe:

Return probe:

Heating probe:

Heating valve actuator probe:

DHW valve actuator probe:

Safety thermostat:

### Other electronic regulating functions

- Reset modulating/mixing valve to zero

Immediately after the power supply has been switched on, the position of the modulating valves is reset to zero.

- Pump anti-seizing

When the pump is not in use, it is powered on for a period of 5 seconds every 24 hours.

- Diverter/modulating valve anti-seizing cycle

The anti-seizing cycle for the diverter/modulating valve is run every 24 hours.

## Periodic Maintenance

The following checks must be carried out at least once every 12 months, in accordance with the prescriptions of standard EN 806-5.

Operations to be Performed
Force an actuators reset by switching the HIU power supply OFF and then ON
Visually check for the absence of leaks and/or anomalies
Check for possible active errors shown on the user interface
Test correct operation of the pump by closing the thermostat contact or forcing it to close
Clean the strainers: on the primary flow line, on the secondary return line, upstream of the domestic water flow meter.
Check for the absence of internal leakage through the modulating valves when none of the services are active
Check correct setting of the set points (DHW and heating). Unless explicitly requested by the user or for normative reasons, a DHW temperature set point of 50°C or lower is recommended
With the primary circuit at working temperature, check that the DHW flow rate at the correct temperature is sufficient

## Summary of the technical parameters

Here follows a summary of the meaning and possible settings of the technical parameters:

Parameter	Meaning	Setting
t00	Not used	-
t01	Heating flow temperature control	0 = fixed set point 1 = fixed set point with RTL 2 = compensated on return temperature 3 = weather compensated
t02	DHW comfort mode	0 = pre-heating of the heat exchanger 1 = DHW re-circulation
t03	Maximum % opening of the heating modulating valve	From 50 to 100
t04	Maximum % opening of the DHW modulating valve	From 50 to 100
t05	Configuration of the closing logic of the auxiliary microswitch	See page 19
t06	DWH temperature control	0 = fixed set point 1 = return temperature limits are frozen
t07	Some settings are frozen	0 = all temperature settings can be modified 1 = return temperature limits are frozen
t08	Anti-legionella	0 = disabled 1 = enabled between 3:00 to 3:30 am
t09	Duration of the DHW re-circulation cycle	1 unit = 10 seconds



## Maintenance

All maintenance procedures should be carried out by an authorised technician. Regular maintenance guarantees better efficiency and helps to save energy.

Before carrying out any maintenance, repair or part replacement work, proceed as follows:

- Switch off the electricity supply
- Remove the cover
- Close the shut-off valves
- Empty the heat interface unit using the drain cocks provided.

## Exchanger replacement

- As a preliminary step, remove the flow sensor (refer to "replacing the DHW priority flow meter") and position it where it cannot be reached by any dripping liquid.
- Remove the exchanger, loosening the 2 hex socket head screws fixing it in place (A)
- Replace the exchanger and the 'O' rings.
- Tighten the two fixing screws (A) after having checked that the 'O' rings are correctly positioned. Tightening torque 3 to 3.5 Nm

**N.B.** Make sure to respect the correct orientation of the plate heat exchanger when re-fitting it.

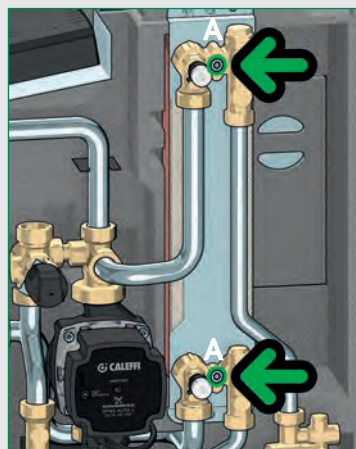

# SATK22 heat interface unit

## Cleaning the HIU primary circuit strainer

All heat interface units have a strainer on the inlet for water from the centralised system.

To clean these strainers, carry out the following maintenance procedure:

- Unscrew the cap (B)
- Remove the strainer mesh and discard any impurities it contains
- Refit the strainer mesh
- Refit the cap and tighten it.

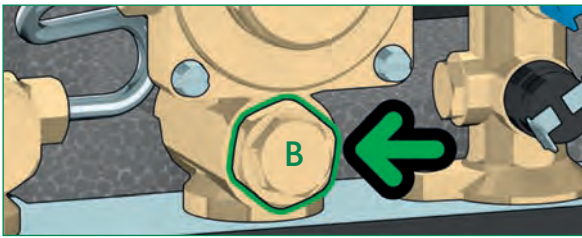

## Temperature probe replacement

- Disconnect the probe cable by bending tab (C) slightly and extracting the connector.
- Unscrew the probe
- Fit the new probe
- Reconnect the connector respecting the only possible way it can be inserted.

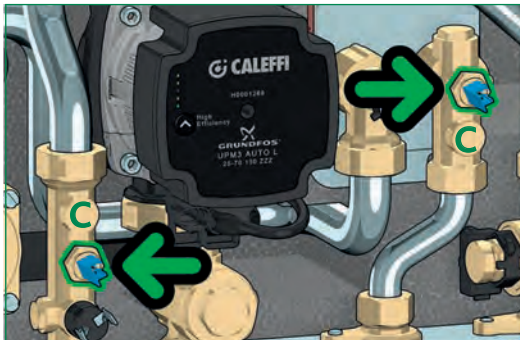

## Replacing the valve obturator

- Extract the fixing clip (D) and then the actuator
- Position the new actuator (E)
- Insert the fixing clip, respecting the correct direction
- Reconnect the connector.

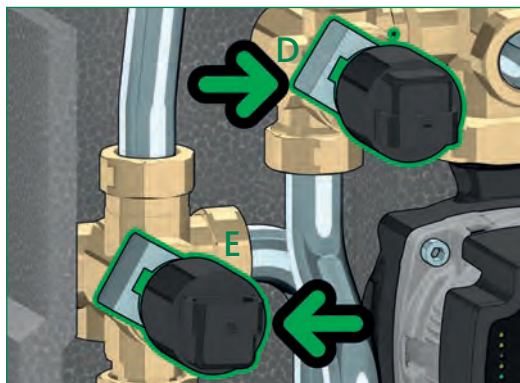

## Replacing the actuator

- Disconnect the valve actuator (see previous paragraph)
- Extract the obturator, unscrewing the locking nut (F)
- Replace the actuator, screw on the locking nut (F) and then fit the actuator
- Insert the fixing clip, respecting the correct direction
- Reconnect the connector.

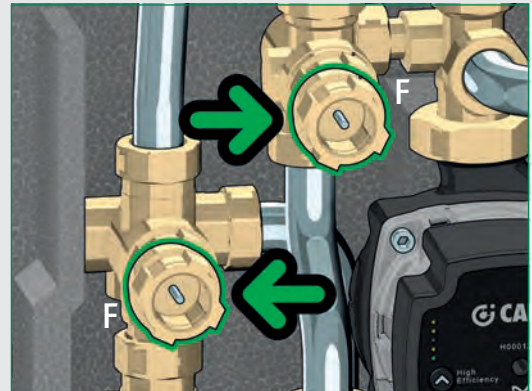

## Replacing the DHW priority flow switch

- Disconnect the flow meter cable acting on the connector
- Extract the flow sensor (G)
- Position the new sensor
- Re-connect the connector respecting the only possible way it can be inserted.



## Replacing or cleaning the DHW priority flow meter turbine

- Extract the flow sensor
- Unscrew and remove the cartridge (H)
- Remove any impurities or change the cartridge if necessary
- Screw the cartridge back in
- Reposition the flow sensor

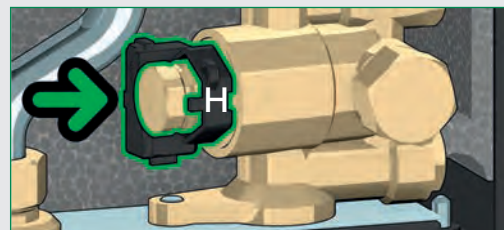







When carrying out maintenance on the electrical part, follow the connectors illustrated on page 20.





After concluding maintenance, proceed with the filling and checking operations described in the chapter "commissioning" (page 9) re-fit the cover.

If you require any information regarding spare parts, please contact Altecnic Limited.

## Fault Finding

Fault	Indications	Possible Cause of Fault	Operations to be Performed
The water is not heating	blinking  icon	primary circuit isolating valve closed	open the isolating valve
		modulating valve actuator disconnected from valve body	re-connect actuator
		modulating valve actuator faulty	call qualified personnel to have it replaced
		DHW temperature probe cable inverted with heating probe	restore correct connection
		presence of air in the system	vent the system
		electronic controller not working	call qualified personnel to have it replaced
		valve obturator blocked in closed position	call qualified personnel to have it replaced
	centralised system not working	contact person in charge of system	
	error code 6 active	DHW temperature probe disconnected	re-connect probe
		DHW temperature probe faulty	call qualified personnel to have it replaced
	error code 80 active	incorrect wiring/no credit	check electrical connections/top-up credit
	constant  icon	DHW priority flow meter disconnected	re-connect flow meter
		DHW priority flow meter faulty	call qualified personnel to have it replaced
Icon  absent	DHW production disabled	enable DHW by means of HIU interface	
display off	electricity power supply switched off	switch on electricity supply	
	protection fuse burnt out	call qualified personnel to have it replaced	
The water is hot but does not reach the desired temperature	blinking  icon	domestic water cycle temperature set point too low	increase set point
		primary return temperature limitation intervention	change the return temperature set point/disable the function
		primary circuit strainer of HIU clogged	call qualified personnel to have it serviced
		exchanger partly clogged	call qualified personnel to have it serviced
		modulating valve actuator faulty	call qualified personnel to have it replaced
		modulating valve actuator connector disconnected	re-connect actuator connector
		DHW temperature probe cable inverted with heating probe	restore correct connection
		excessive demand for DHW	decrease demand
		electronic controller not working	call qualified personnel to have it replaced
		centralised system temperature insufficient	contact person in charge of system
		primary circuit flow rate insufficient	contact person in charge of system
		primary flow rate limit too low	contact person in charge of system
The hot water temperature reached is too high	blinking  icon	domestic water cycle temperature set point too high	decrease set point
		DHW temperature probe cable inverted with heating probe	restore correct connection
		modulating valve actuator faulty	call qualified personnel to have it replaced
		valve obturator blocked in intermediate or open position	call qualified personnel to have it replaced
		electronic controller not working	call qualified personnel to have it replaced
		primary circuit excessive flow rate due to DPCV valve malfunctioning	call qualified personnel to have it replaced
		anti-legionella cycle in progress	contact person in charge of system
Hot water flow rate is insufficient	blinking  icon	HIU strainer clogged	call qualified personnel to have it replaced
		possible domestic water system shut-off valves partly closed	open the valves
		insufficient pressure in central domestic water circuit	call qualified personnel to have it serviced

## Fault Finding

Fault	Indications	Possible Cause of Fault	Operations to be Performed
There is no hot water flow	DHW led off	possible domestic water system shut-off valves closed	open the valves
		no cold water in centralised domestic circuit	call qualified personnel to have it serviced
		HIU strainer completely clogged	call qualified personnel to have it serviced
		heat exchanger completely blocked	call qualified personnel to have it serviced
The room is not reaching the desired temperature	blinking  icon	heating cycle temperature set point too low	increase set point
		chrono-thermostat temperature setting incorrect	check programming of chrono-thermostat
		HIU strainer clogged	call qualified personnel to have it serviced
		primary return temperature limitation intervention (the following icon appears  )	change the return temperature set point/disable the function
		primary flow rate in heating mode set at an excessively low limit	change heating valve open limit
		heating valve actuator faulty	call qualified personnel to have it replaced
		heating valve obturator blocked	call qualified personnel to have it replaced
		modulating valve actuator connector disconnected	restore correct connection
		DHW temperature probe cable inverted with heating probe	restore correct connection
		presence of air in the system	vent the system
		pump not working	call qualified personnel to have it replaced
		pump cable not connected	restore connection
		possible system shut-off valves/terminals closed	open the valves
		centralised system temperature insufficient	contact person in charge of system
		electronic controller not working	call qualified personnel to have it replaced
		primary circuit flow rate insufficient	contact person in charge of system
		centralised system not working	contact person in charge of system
		thermostat function enabled on the remote interface when it should be disabled	contact person in charge of system
		constant  icon	timer/thermostat time setting incorrect
	timer/thermostat not working		check timer/thermostat
	thermostat function disabled on the remote interface		contact person in charge of system
	display off	electric supply switched off	restore HIU electric supply
		protection fuse burnt out	call qualified personnel to have it replaced
	icon  absent	heating not enabled (summer mode)	enable heating by means of heat interface unit
	error code 5 active	heating temperature probe faulty	call qualified personnel to have it replaced
	error code 15 active	compensation temperature probe faulty	call qualified personnel to have it replaced
	error code 38 active	external temperature probe faulty/ not connected	call qualified personnel to have it replaced
	error code 69 active	safety thermostat cut in	call qualified personnel to have it serviced
	error code 76 active	thermal safety solenoid valve faulty	call qualified personnel to have it serviced
error code 80 active	no credit	top-up prepayment system	

## Commissioning Check List

Item	Checks to be Performed	Completed
1	Is the heat interface unit properly secured to the wall?	
2	Has the system flushing been carried out?	
3	Check strainers and clean them if necessary	
4	Is the heat meter (if present) connected?	
5	Is the heat meter (if present) connected to the building data logger (if required)?	
6	Is the DCW line fitted with a pressure reducing valve?	
7	Are the shut-off valves open?	
8	Has the visual inspection of the hydraulic sealing efficiency produced positive results?	
9	Has the system (primary) been filled and vented?	
10	Has the visual inspection of the HIU internal electrical connections given a positive result and are the connections compliant with specifications and made in accordance with best practices?	
11	Is the heat interface unit connected to the 230 V ac electric supply? Is the remote user interface connected?	
12	Have the optional connections (external sensor, prepayment, auxiliary microswitch, Modbus, if required) been carried out?	
13	Has the remote user interface been configured for installation on board (thermostat function disabled)/inside the apartment (with thermostat function enabled)	
14	Have the heating, DHW and comfort functions (if required) been activated?	
15	Have the heating and DHW set points been configured correctly (when applicable)	
16	Have the optional functions (return temperature limitation, return/weather compensation, anti-legionella, primary flow rate limitation) been enabled (if required) and configured?	
17	Have the external room thermostats (if required) been connected?	
18	No error code on heat interface unit remote user interface?	
19	Is the primary circuit at working temperature?	
20	Check that heating starts (blinking icon) by simulating a heating request	
21	Check that the pump functions correctly when the thermostat is activated (check that the secondary flow pipes heat up)	
22	Simulate minimal DHW tapping (approx 3 l/min) and check that "DHW" LED lights and that water is supplied at the required temperature	
23	Simulate abundant DHW tapping and check, by means of the installed heat meter, that the primary circuit flow rate is sufficiently high	

Altecnic Ltd Mustang Drive, Stafford, Staffordshire ST16 1GW

T: +44 (0)1785 218200 E: [sales@altecnic.co.uk](mailto:sales@altecnic.co.uk)

Registered in England No: 2095101

[altecnic.co.uk](http://altecnic.co.uk)

IOM 106 23-02-18

E & O.E

© Altecnic Limited. 2018

ALTECNIC™