



MICROFLEX[®]

Flexibility, all the way.

Catalog

Edition 2016



Flexibility is in our nature

MICROFLEX[®]

Flexibility, all the way.

Watts Water Technologies EMEA B.V. is the European Holding and Division of Watts Water Technologies Inc., a leading multinational listed on the New York Stock Exchange. Watts develops and manufactures products that promote the comfort and safety of people, and the quality and protection of water in residential, commercial and industrial applications.

Over the past 20 years Watts Insulation has built up strong expertise in the development and manufacture of highly flexible pre-insulated PE-Xa pipes for hot and cold potable water, cooling water, wastewater and other fluids.

All our processes are ISO 9001 certified, and every part of the Microflex system is designed with care. Only the best materials are selected for our uniquely high-tech production line. Efficient logistics management guarantees very short delivery terms. We have a team of professionals that are motivated to give you the best possible advice every time.

Watts Insulation, your expert partner in highly flexible energy saving piping systems!

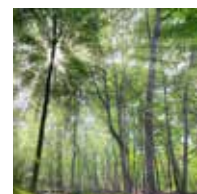

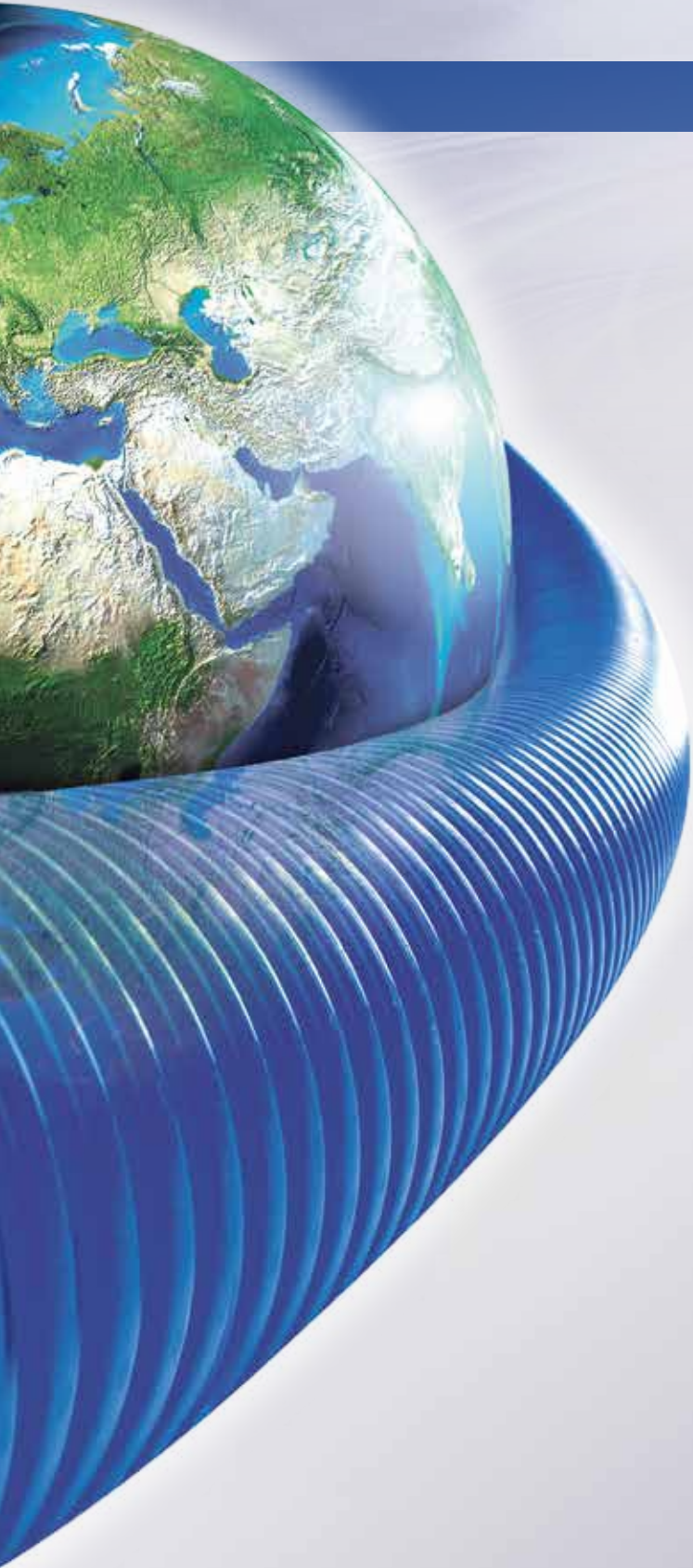

Microflex. Saving energy and preserving the environment

Microflex manufactures products that contribute to a sustainable future. Our products help keep energy consumption and CO₂ emissions to a minimum.

Microflex pipes are durable, contain no pollutants and are non-toxic. All materials used are produced without CFCs (chlorofluorocarbons) that can deplete the ozone layer. During the production process we are highly conscious of energy consumption and there is no pollution of air, water or soil.

Microflex. Ideal for renewable energy applications

Geothermal heat pumps



Heat pumps for air / ground water



Wood and pellet boilers



Biomass and biogas



MICROFLEX®
Flexibility, all the way.

Microflex's unique assets: flexibility, durability and product superiority

Flexibility, all the way

In order & delivery

- 200,000 metres of pipes in stock
- Local stocks at regional distributors close to your site
- All sizes available in full coils of 100 m or per metre
- All couplings and system accessories in stock

In installation

- No couplings or accessories necessary to overcome obstacles
- Faster assembly times
- No skilled welders required to make the connections
- No specific assembly tools required
- No expensive pre-insulated bends required
- Limited weight facilitates easy installation
- Simple and safe modular system of connections, including insulation and finishing kits
- Individual approach to market-specific demands outside of standard solutions



Durable and superior products & system solutions



- Very extensive range of pipes and accessories – complete system
- High quality standards backed up by ISO 9001 certification
- Couplings with the highest performance on the market
- Microflex cross-linked PE-X insulation sheet foam with closed cell structure, delivering significantly superior insulating properties

In a heating network operating at a 80°C/60°C temperature regime, 100 m of our MD20063C pipe limits the temperature drop to only 0.2°C at its maximum capacity (235 kW)

- Outstanding aging resistance of the Microflex insulation material, a lifetime of high insulation performance
- Unique double wall outside casing in PE-HD providing extra protection to the inner part of the tube
- Sophisticated geometry of outside casing ensuring unparalleled flexibility and high resistance to impacts and pressure
- Corrosion-free system and transport pipes with extremely long life and high resistance to external influences such as stress, micro-organisms and temperature swings
- Total project supervision by experienced staff – engineering, planning, calculations, material selection and more

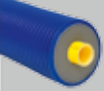
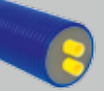
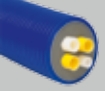
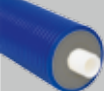
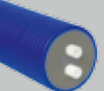
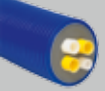
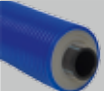
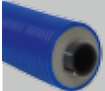
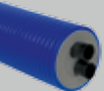

A solution for every application

Product selector	Uno (one pipe)	Uno V (one pipe + cable)	Duo (two pipes)	Quadro (four pipes)
Heating water (PE-Xa)	 > M-C		 > MD-C	 > MQ
Hot (potable) water (PE-Xa)	 > M-S		 > MD-S	 > MQ
Cold (potable) water and cooling water (PE100)	 > M-PE	 > MV-PE	 > MD-PE	
Accessories				



Microflex is the complete and ultra-flexible solution for a network of insulated pipes. These include heating pipes, hot sanitary water pipes, cooling water pipes, conduits to carry other fluids etc.

Medium pipes in PE-Xa of 25 mm (DN20) to 125 mm (DN100) in uno, duo or quadro versions.

Your guarantee of quality



Expert advice tailored to your needs

Got a question about our products or delivery terms?
Need help to calculate your material needs?
Do you have a special requirement?
Our staff will be delighted to help you.

Customer service: Tel +32 (0)16 44 21 37
Fax +32 (0)16 44 03 68
Mail: microflexsales@wattswater.com
Orders: Mail: microflexlogistics@wattswater.com
General information: Tel +32 (0)16 44 21 31



TABLE OF CONTENTS

CENTRAL HEATING

MICROFLEX® UNO	8
MICROFLEX® PRIMO UNO	9
MICROFLEX® DUO	10
MICROFLEX® PRIMO DUO	11

SANITARY

MICROFLEX® UNO	12
MICROFLEX® DUO	13
MICROFLEX® PRIMO DUO	14

CENTRAL HEATING AND SANITARY

MICROFLEX® QUADRO	15
-------------------------	----

COLD AND COOLING WATER

MICROFLEX® COOL	16
MICROFLEX® COOL with self-regulating heating cable	17
MICROFLEX® connection kit for heating cable	18
Heat loss table for MICROFLEX® COOL with self-regulating heating cable	19
Self-regulating heating cable – structure and operation	20
MICROFLEX® PE-X couplings - 6/16 Bar	21
MICROFLEX® PE-X couplings - 10 Bar	23
Accessories	24
Plastic couplings for PE pipes	27
Accessories outside casing	28
Wall feed-throughs	29
Underground insulation kits	30
Certificates	33
Installation guidelines	34
Installation guidelines	35
Heat loss	37
Pressure loss	38
Pressure test	40
Project assistance	41
Service	42
General terms and conditions	43



Sales conditions *(Refer to price list)*

- All our prices are without VAT.
- Our sales and delivery conditions apply to all our products.
- This is the only valid catalog. It replaces all previous editions.
- Technical and substantive changes may be made without prior notice.
- Cut to length tubes are not taken back.
- Our prices are ex works.

CENTRAL HEATING

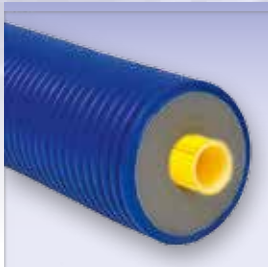

MICROFLEX® UNO

Single flexible, pre-insulated, self-compensating, underground pipe. Especially suitable for heating water, but also for (hot) potable water, wastewater and other fluids.

Corrosion-resistant transport pipe in cross-linked PE-Xa in accordance with EN ISO 15875, with yellow oxygen diffusion barrier in accordance with DIN 4726. Thermal, elastic, CFC-free foam insulation made from cross-linked PE-X with closed microcellular structure. Minimal water absorption capacity of < 1% in accordance with ISO 2896. Corrugated outside casing in HDPE, made in accordance with the closed chamber principle to provide high-grade protection to the piping system.

- Max operating pressure: 6 bar
- Max fluid temperature: + 95°C
- PE-Xa pipes: SDR 11
- Standard full coil length: 100 m

**Specific combinations?
Please contact us.**

WRAS approval

PIPES

Art. No.	PE-Xa d _{out} /s	PE-Xa d _{in}	Outside casing d _{out}	Weight kg/m	Bending radius (1)	Heat emission (2)
Art. No.	mm	DN	mm	kg/m	m	kW
M7525 C	25/2.3	20	75	0.68	0.20	~30
M9032 C	32/2.9	25	90	1.00	0.25	~60
M16040 C	40/3.7	32	160	2.32	0.35	~90
M16050 C	50/4.6	40	160	2.48	0.45	~140
M16063 C	63/5.8	50	160	2.78	0.55	~220
M20075 C	75/6.8	65	200	4.16	0.80	~330
M20090 C	90/8.2	75	200	4.73	1.10	~480
M200110 C	110/10.0	90	200	5.64	1.20	~700
M200125 C	125/11.4	100	200	6.00	1.40	~900

(1) Applicable practical values without risk of pipe distortion or damage.

(2) Average heat emission in kW at T_{water} of 80°C and ΔT of 20°C.

COUPLINGS



Microflex PE-X coupling	Thread
Art. No.	inch
MJ3413425/23	3/4" M
MJ3414432/29	1" M
MJ3415440/37	1 1/4" M
MJ3416450/46	1 1/2" M
MJ341263/58	2" M
MJ34121275/68	2 1/2" M
MJ341390/82	3" M
MJ3414110/100	4" M
MJ3414125/114	4" M

ACCESSORIES

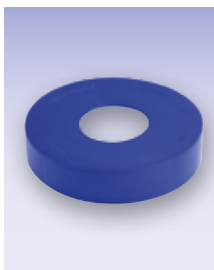

Fix points must be installed to absorb the possible effects of thermal expansion / shrinkage of the PE-Xa transport pipes.



Pipe	Dust cap MS	Shrink cap MK	Rubber End cap EPDM	Fix point MFP	Thread
Art. No.	Art. No.	Art. No.	Art. No.	Art. No.	inch
M7525 C	MS7525	MK2000	MG751832	MFP34	3/4" M
M9032 C	MS9032	MK2100	MG901840	MFP44	1" M
M16040 C	MS16040	MK2340	MG1603250	MFP54	1 1/4" M
M16050 C	MS16050	MK2340	MG1603250	MFP64	1 1/2" M
M16063 C	MS16063	MK2500	MG1603390	MFP2	2" M
M20075 C	MS20075	MK2600	M20075125	MFP212	2 1/2" M
M20090 C	MS20090	MK2600	MG20075125	MFP3	3" M
M200110 C	MS200110	MK2600	MG20075125	MFP4	4" M
M200125 C	MS200125	MK2600	MG20075125	MFP4	4" M

CENTRAL HEATING

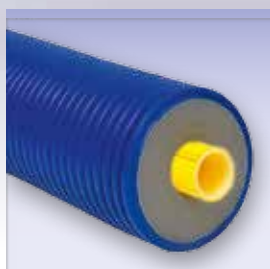

MICROFLEX® PRIMO UNO

Single flexible, pre-insulated, self-compensating, underground pipe. Especially suitable for heating water, but also for (hot) potable water, wastewater and other fluids.

Corrosion-resistant transport pipe in cross-linked PE-Xa in accordance with EN ISO 15875, with yellow oxygen diffusion barrier in accordance with DIN 4726. Thermal, elastic, CFC-free foam insulation made from cross-linked PE-X with closed microcellular structure. Minimal water absorption capacity of < 1% in accordance with ISO 2896. Corrugated outside casing in HDPE, made in accordance with the closed chamber principle to provide high-grade protection to the piping system.

- Max operating pressure: 6 bar
- Max fluid temperature: + 95°C
- PE-Xa pipes: SDR 11
- Standard full coil length: 100 m

Specific combinations?
Please contact us.

WRAS approval
Water Regulations Advisory Scheme

PIPES

Art. No.	PE-Xa d _{out} /s	PE-Xa d _{in}	Outside casing d _{out}	Weight kg/m	Bending radius (1)	Heat emission (2)
Art. No.	mm	DN	mm	kg/m	m	kW
M9040 C	40/3.7	32	90	1.11	0.30	~90
M12540 C	40/3.7	32	125	1.72	0.30	~90
M12550 C	50/4.6	40	125	1.92	0.40	~140
M12563 C	63/5.8	50	125	2.16	0.50	~220
M16075 C	75/6.8	65	160	3.20	0.75	~330
M16090 C	90/8.2	75	160	3.85	1.00	~480

(1) Applicable practical values without risk of pipe distortion or damage.

(2) Average heat emission in kW at T_{water} of 80°C and ΔT of 20°C.

COUPLINGS



Microflex PE-X coupling	Thread
Art. No.	inch
MJ3415440/37	1 1/4" M
MJ3415440/37	1 1/4" M
MJ3416450/46	1 1/2" M
MJ341263/58	2" M
MJ34121275/68	2 1/2" M
MJ341390/82	3" M

ACCESSORIES

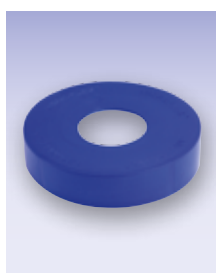

Fix points must be installed to absorb the possible effects of thermal expansion / shrinkage of the PE-Xa transport pipes.



Pipe	Dust cap MS	Shrink cap MK	Rubber End cap EPDM	Fix point MFP	Thread
Art. No.	Art. No.	Art. No.	Art. No.	Art. No.	inch
M9040 C	MS9040	MK2100	MG901840	MFP54	1 1/4" M
M12540 C	MS12540	MK2200	MG1254063	MFP54	1 1/4" M
M12550 C	MS12550	MK2200	MG1254063	MFP64	1 1/2" M
M12563 C	MS12563	MK2400	MG1254063	MFP2	2" M
M16075 C	MS16075	MK2500	MG1606390	MFP212	2 1/2" M
M16090 C	MS16090	MK2500	MG1606390	MFP3	3" M

CENTRAL HEATING

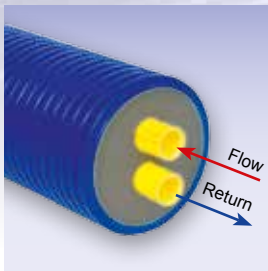

MICROFLEX® DUO

Double flexible, pre-insulated, self-compensating, underground pipe. Especially suitable for heating water, but also for (hot) potable water, wastewater and other fluids.

Corrosion-resistant transport pipe in cross-linked PE-Xa in accordance with EN ISO 15875, with yellow oxygen diffusion barrier in accordance with DIN 4726. Thermal, elastic, CFC-free foam insulation made from cross-linked PE-X with closed microcellular structure. Minimal water absorption capacity of < 1% in accordance with ISO 2896. Insulating PE centrepiece guarantees an effective separation of flow and return pipes. Corrugated outside casing in HDPE, made in accordance with the closed chamber principle to provide high-grade protection to the piping system.

- Max operating pressure: 6 bar
- Max fluid temperature: + 95°C
- PE-Xa pipes: SDR 11
- Standard full coil length: 100 m

Specific combinations?
Please contact us.

WRAS approval

PIPES

Art. No.	PE-Xa d _{out} /s	PE-Xa d _{in}	Outside casing d _{out}	Weight kg/m	Bending radius (1)	Heat emission (2)
Art. No.	mm	DN	mm	kg/m	m	kW
MD16025 C	2 x 25/2.3	20	160	2.21	0.50	~30
MD16032 C	2 x 32/2.9	25	160	2.41	0.50	~60
MD16040 C	2 x 40/3.7	32	160	2.63	0.60	~90
MD20050 C	2 x 50/4.6	40	200	4.03	0.80	~140
MD20063 C	2 x 63/5.8	50	200	4.64	1.20	~220

- (1) Applicable practical values without risk of pipe distortion or damage.
(2) Average heat emission in kW at T_{water} of 80°C and ΔT of 20°C.

COUPLINGS



Microflex PE-X coupling (*)	Thread
Art. No.	inch
MJ3413425/23	3/4" M
MJ3414432/29	1" M
MJ3415440/37	1 1/4" M
MJ3416450/46	1 1/2" M
MJ341263/58	2" M

(*) For Duo pipes, two couplings required.

ACCESSORIES

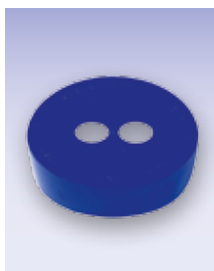

Fix points must be installed to absorb the possible effects of thermal expansion / shrinkage of the PE-Xa transport pipes.



Pipe	Dust cap MSD	Shrink cap MK	Rubber End cap EPDM	Fix point MFP (*)	Thread
Art. No.	Art. No.	Art. No.	Art. No.	Art. No.	inch
MD16025 C	MSD16025	MK3350-01	MGD1602550	MFP34	3/4" M
MD16032 C	MSD16032	MK3350-01	MGD1602550	MFP44	1" M
MD16040 C	MSD16040	MK3350-02	MGD1602550	MFP54	1 1/4" M
MD20050 C	MSD20050	MK3350-03	MGD2004063	MFP64	1 1/2" M
MD20063 C	MSD20063	MK3350-05	MGD2004063	MFP2	2" M

(*) For Duo pipes, two fix points required.

CENTRAL HEATING

MICROFLEX® PRIMO DUO

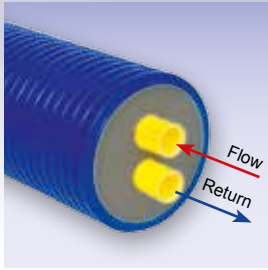

Double flexible, pre-insulated, self-compensating, underground pipe. Especially suitable for heating water, but also for (hot) potable water, wastewater and other fluids.

Corrosion-resistant transport pipe in cross-linked PE-Xa in accordance with EN ISO 15875, with yellow oxygen diffusion barrier in accordance with DIN 4726. Thermal, elastic, CFC-free foam insulation made from cross-linked PE-X with closed microcellular structure. Minimal water absorption capacity of < 1% in accordance with ISO 2896. Insulating PE centrepiece guarantees an effective separation of flow and return pipes. Corrugated outside casing in HDPE, made in accordance with the closed chamber principle to provide high-grade protection to the piping system.

- Max operating pressure: 6 bar
- Max fluid temperature: + 95°C
- PE-Xa pipes: SDR 11
- Standard full coil length: 100 m

**Specific combinations?
Please contact us.**

WRAS approval

PIPES

	PE-Xa d_{out}/s	PE-Xa d_{in}	Outside casing d_{out}	Weight	Bending radius (1)	Heat emission (2)
Art. No.	mm	DN	mm	kg/m	m	kW
MD12525 C	2 x 25/2.3	20	125	1.62	0.30	~30
MD12532 C	2 x 32/2.9	25	125	1.82	0.30	~60
MD16040 C	2 x 40/3.7	32	160	2.63	0.60	~90
MD16050 C	2 x 50/4.6	40	160	3.10	0.60	~140

(1) Applicable practical values without risk of pipe distortion or damage.

(2) Average heat emission in kW at T_{water} of 80°C and ΔT of 20°C.

COUPLINGS



Microflex PE-X coupling (*)	Thread
Art. No.	inch
MJ3413425/23	3/4" M
MJ3414432/29	1" M
MJ3415440/37	1 1/4" M
MJ3416450/46	1 1/2" M

(*) For Duo pipes, two couplings required.

ACCESSORIES



Fix points must be installed to absorb the possible effects of thermal expansion / shrinkage of the PE-Xa transport pipes.



Pipe	Dust cap MSD	Shrink cap MK	Rubber End cap EPDM	Fix point MFP (*)	Thread
Art. No.	Art. No.	Art. No.	Art. No.	Art. No.	inch
MD12525 C	MSD12525	MK3250-P604	MGD1251832	MFP34	3/4" M
MD12532 C	MSD12532	MK3280	MGD1251832	MFP44	1" M
MD16040 C	MSD16040	MK3350-02	MGD1602550	MFP54	1 1/4" M
MD16050 C	MSD16050	MK3350-03	MGD1602550	MFP64	1 1/2" M

(*) For Duo pipes, two fix points required.

SANITARY

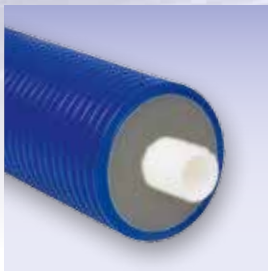

MICROFLEX® UNO

Single flexible, pre-insulated, self-compensating, underground pipe. Especially suitable for hot and cold potable water, but also for waste-water and other fluids.

Corrosion-resistant transport pipe in cross-linked PE-Xa in accordance with EN ISO 15875. Thermal, elastic, CFC-free foam insulation made from cross-linked PE-X with closed microcellular structure. Minimal water absorption capacity of < 1% in accordance with ISO 2896. Corrugated outside casing in HDPE, made in accordance with the closed chamber principle to provide high-grade protection to the piping system.

- Max operating pressure: 10 bar
- Max fluid temperature: + 95°C
- PE-Xa pipes: SDR 7.4
- Standard full coil length: 100 m

Specific combinations?
Please contact us.

WRAS approval
Water Regulations Advisory Scheme

PIPES

	PE-Xa d _{out} /s	PE-Xa d _{in}	Outside casing d _{out}	Weight	Bending radius (1)
Art. No.	mm	DN	mm	kg/m	m
M7525 S	25/3.5	20	75	0.75	0.20
M9032 S	32/4.4	25	90	1.12	0.25
M12540 S	40/5.5	32	125	1.89	0.40
M12550 S	50/6.9	40	125	2.19	0.50
M12563 S	63/8.7	50	125	2.59	0.60
M20075 S	75/10,3	65	200	4.83	0.90
M20090 S	90/12,3	75	200	5.63	1.20
M200110 S	110/15,1	90	200	6.85	1.30

(1) Applicable practical values without risk of pipe distortion or damage.

COUPLINGS



Microflex PE-X coupling	Thread
Art. No.	inch
MJ3413425/35	3/4" M
MJ3414432/44	1" M
MJ3415440/55	1 1/4" M
MJ3416450/69	1 1/2" M
MJ341263/87	2" M
MJ34121275/103	2 1/2" M
MJ341390/123	3" M
MJ3414110/151	4" M

ACCESSORIES

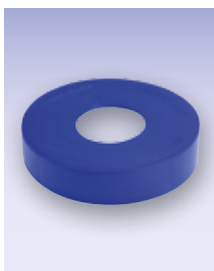

Fix points must be installed to absorb the possible effects of thermal expansion / shrinkage of the PE-Xa transport pipes.



Pipe	Dust cap MS	Shrink cap MK	Rubber End cap EPDM	Fix point MFP	Thread
Art. No.	Art. No.	Art. No.	Art. No.	Art. No.	inch
M7525 S	MS7525	MK2000	MG751832	MFP34	3/4" M
M9032 S	MS9032	MK2100	MG901840	MFP44	1" M
M12540 S	MS12540	MK2200	MG1254063	MFP54	1 1/4" M
M12550 S	MS12550	MK2200	MG1254063	MFP64	1 1/2" M
M12563 S	MS12563	MK2400	MG1254063	MFP2	2" M
M20075 S	MS20075	MK2600	MG20075125	MFP212	2 1/2" M
M20090 S	MS20090	MK2600	MG20075125	MFP3	3" M
M200110 S	MS200110	MK2600	MG20075125	MFP4	4" M

SANITARY

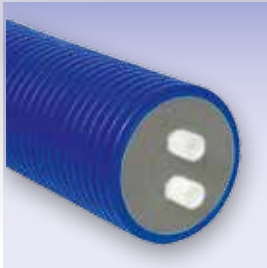

MICROFLEX® DUO

Double flexible, pre-insulated, self-compensating, underground pipe. Especially suitable for hot and cold potable water, but also for wastewater and other fluids.

Corrosion-resistant transport pipe in cross-linked PE-Xa in accordance with EN ISO 15875. Thermal, elastic, CFC-free foam insulation made from cross-linked PE-X with closed microcellular structure. Minimal water absorption capacity of < 1% in accordance with ISO 2896. Insulating PE centrepiece guarantees an effective separation of sanitary hot water pipe and pipe for circulation loop. Corrugated outside casing in HDPE, made in accordance with the closed chamber principle to provide high-grade protection to the piping system.

- Max operating pressure: 10 bar
- Max fluid temperature: + 95°C
- PE-Xa pipes: SDR 7.4
- Standard full coil length: 100 m

Specific combinations?
Please contact us.

WRAS approval
Water Regulations Advisory Scheme

PIPES

Art. No.	PE-Xa d _{out} /s	PE-Xa d _{in}	Outside casing d _{out}	Weight kg/m	Bending radius (1)
Art. No.	mm	DN	mm	kg/m	m
MD16025 S	2 x 25/3.5	20	160	2.35	0.50
MD1603225 S	1 x 32/4.4	25	160	2.50	0.50
	1 x 25/3.5	20			
MD1604025 S	1 x 40/5.5	32	160	2.71	0.60
	1 x 25/3.5	20			
MD1605025 S	1 x 50/6.9	40	160	2.89	0.60
	1 x 25/3.5	20			
MD1605032 S	1 x 50/6.9	40	160	3.04	0.60
	1 x 32/4.4	25			

(1) Applicable practical values without risk of pipe distortion or damage.

COUPLINGS



Microflex PE-X coupling	Thread
Art. No.	inch
MJ3413425/35 (*)	3/4" M
MJ3414432/44	1" M
MJ3413425/35	3/4" M
MJ3415440/55	1 1/4" M
MJ3413425/35	3/4" M
MJ3416450/69	1 1/2" M
MJ3413425/35	3/4" M
MJ3416450/69	1 1/2" M
MJ3414432/44	1" M

(*) Two couplings required.

ACCESSORIES



Fix points must be installed to absorb the possible effects of thermal expansion / shrinkage of the PE-Xa transport pipes.



Pipe	Dust cap MSD	Shrink cap MK	Rubber End cap EPDM	Fix point MFP	Thread
Art. No.	N° art.	N° art.	N° art.	N° art.	inch
MD16025 S	MSD16025	MK3350-01	MGD1602550	MFP34 (*)	3/4" M
MD1603225 S	MSD1603225	MK3350-01	MGD1602550	MFP44	1" M
				MFP34	3/4" M
MD1604025 S	MSD1604025	MK3350-02	MGD1602550	MFP54	1 1/4" M
				MFP34	3/4" M
MD1605025 S	MSD1605025	MK3360-01	MGD1602550	MFP64	1 1/2" M
				MFP34	3/4" M
MD1605032 S	MSD1605032	MK3350-03	MGD1602550	MFP64	1 1/2" M
				MFP44	1" M

(*) Two fix points required.

SANITARY

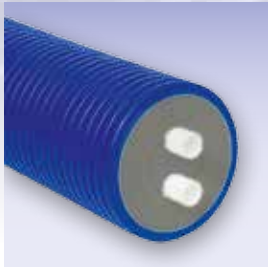

MICROFLEX® PRIMO DUO

Double flexible, pre-insulated, self-compensating, underground pipe. Especially suitable for hot and cold potable water, but also for wastewater and other fluids.

Corrosion-resistant transport pipe in cross-linked PE-Xa in accordance with EN ISO 15875. Thermal, elastic, CFC-free foam insulation made from cross-linked PE-X with closed microcellular structure. Minimal water absorption capacity of < 1% in accordance with ISO 2896. Insulating PE centrepiece guarantees an effective separation of sanitary hot water pipe and pipe for circulation loop. Corrugated outside casing in HDPE, made in accordance with the closed chamber principle to provide high-grade protection to the piping system.

- Max operating pressure: 10 bar
- Max fluid temperature: + 95°C
- PE-Xa pipes: SDR 7.4
- Standard full coil length: 100 m

Specific combinations?
Please contact us.

WRAS approval
Water Regulations Advisory Scheme

PIPES

Art. No.	PE-Xa d _{out} /s	PE-Xa d _{in}	Outside casing d _{out}	Weight kg/m	Bending radius (1)
MD1252520 S	1 x 25/3.5 1 x 20/2.8	20 15	125	1.68	0.30
MD1253225 S	1 x 32/4.4 1 x 25/3.5	25 20	125	1.91	0.30

(1) Applicable practical values without risk of pipe distortion or damage.

COUPLINGS



Microflex PE-X coupling	Thread
Art. No.	inch
MJ3413425/35	3/4" M
MJ3413420/28	3/4" M
MJ3414432/44	1" M
MJ3413425/35	3/4" M

ACCESSORIES

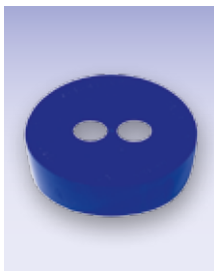

Fix points must be installed to absorb the possible effects of thermal expansion / shrinkage of the PE-Xa transport pipes.



Pipe	Dust cap MSD	Shrink cap MK	Rubber End cap EPDM	Fix point MFP	Thread
Art. No.	Art. No.	Art. No.	Art. No.	Art. No.	inch
MD1252520 S	MSD1252520	MK3250-P604	MGD1251832	MFP34	3/4" M
MD1253225 S	MSD1253225	MK3250-P604	MGD1251832	MFP44	1" M
				MFP34	3/4" M

CENTRAL HEATING AND SANITARY

MICROFLEX® QUADRO

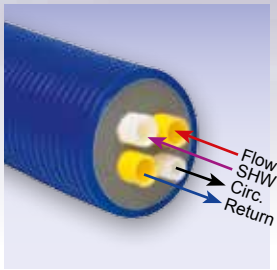

Flexible pre-insulated, self-compensating underground pipe comprising two heating pipes and two sanitary pipes. Designed for heating water (flow and return), and equipped with a sanitary hot water pipe and a pipe for the circulation loop.

Corrosion-resistant transport pipe in cross-linked PE-Xa in accordance with EN ISO 15875, with yellow oxygen diffusion barrier in accordance with DIN 4726 for the heating water pipes. Thermal, elastic, CFC-free foam insulation made from cross-linked PE-X with closed microcellular structure. Minimal water absorption capacity of < 1% in accordance with ISO 2896. Insulating PE centrepiece guarantees an effective separation of flow, return, hot water and circulation pipes. Corrugated outside casing in HDPE, made in accordance with the closed chamber principle to provide high-grade protection to the piping system.

Heating pipes

- Max operating pressure: 6 bar
- Max fluid temperature: + 95°C
- PE-Xa pipes: SDR 11

Sanitary pipes

- Max operating pressure: 10 bar
- Max fluid temperature: + 95°C
- PE-Xa pipes: SDR 7.4
- Standard full coil length: 100 m

Specific combinations?
Please contact us.

WRAS approval
Water Regulations Advisory Scheme



PIPES

	PE-Xa d _{out} /s	PE-Xa d _{in}	Outside casing d _{out}	Weight	Bending radius (1)
Art. No.	mm	DN	mm	kg/m	m
MQ16025C2520S	2 x 25/2.3	20	160	2.54	0.60
	1 x 25/3.5	20			
	1 x 20/2.8	15			
MQ16032C2520S	2 x 32/2.9	25	160	2.72	0.60
	1 x 25/3.5	20			
	1 x 20/2.8	15			
MQ16032C3225S	2 x 32/2.9	25	160	2.95	0.60
	1 x 32/4.4	25			
	1 x 25/3.5	20			
MQ20040C4032S	2 x 40/3.7	32	200	5.00	1.30
	1 x 40/5.5	32			
	1 x 32/4.4	25			

(1) Applicable practical values without risk of pipe distortion or damage.

COUPLINGS

Microflex PE-X coupling	Thread
Art. No.	inch
MJ3413425/23 (*)	3/4" M
MJ3413425/35	3/4" M
MJ3413420/28	3/4" M
MJ3414432/29 (*)	1" M
MJ3413425/35	3/4" M
MJ3413420/28	3/4" M
MJ3414432/29 (*)	1" M
MJ3414432/44	1" M
MJ3413425/35	3/4" M
MJ3415440/37 (*)	1 1/4" M
MJ3415440/55	1 1/4" M
MJ3414432/44	1" M

(*) Two couplings required.

ACCESSORIES

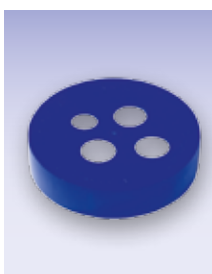

Fix points must be installed to absorb the possible effects of thermal expansion / shrinkage of the PE-Xa transport pipes.



Pipe	Dust cap MSQ	Rubber End cap EPDM	Fix point MFP	Thread
Art. No.	Art. No.	Art. No.	Art. No.	inch
MQ16025C2520S	MSQ160252520	MGQ1602532	MFP34 (*)	3/4" M
			MFP34	3/4" M
			MFP34	3/4" M
MQ16032C2520S	MSQ160322520	MGQ1602532	MFP44 (*)	1" M
			MFP34	3/4" M
			MFP34	3/4" M
MQ16032C3225S	MSQ160323225	MGQ1602532	MFP44 (*)	1" M
			MFP44	1" M
			MFP34	3/4" M
MQ20040C4032C	MSQ200404032		MPF54 (*)	1 1/4" M
			MFP54	1 1/4" M
			MFP44	1" M

(*) Two fix points required.

COLD AND COOLING WATER

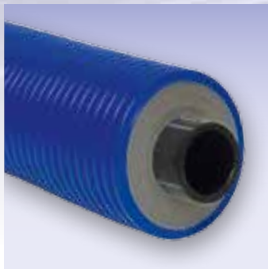

MICROFLEX® COOL

Single flexible, pre-insulated, self-compensating, underground pipe. Suitable for cold potable water, cooling water and wastewater. Corrosion-resistant transport pipe in PE 100 in accordance with EN 12201. Thermal, elastic, CFC-free foam insulation made from cross-linked PE-X with closed microcellular structure. Minimal water absorption capacity of < 1% in accordance with ISO 2896. Corrugated outside casing in HDPE, made in accordance with the closed chamber principle to provide high-grade protection to the piping system.

- Max operating pressure: 16 bar
- Max fluid temperature: -10°C ... +25°C
- PE pipes: SDR 11
- Standard full coil length: 100 m

Specific combinations?
Please contact us.

WRAS approval

DUO COOL only available on request

PIPES

	PE d _{out} /s	PE d _{in}	Outside casing d _{out}	Weight	Bending radius (1)
Art. No.	mm	DN	mm	kg/m	m
M9032 PE	32/2.9	25	90	1.00	0.25
M9040 PE	40/3.7	32	90	1.11	0.30
M12550 PE	50/4.6	40	125	1.92	0.40
M12563 PE	63/5.8	50	125	2.16	0.50
M16075 PE	75/6.8	65	160	3.20	0.75
M16090 PE	90/8.2	75	160	3.85	1.00
M200110 PE	110/10.0	90	200	5.74	1.20
M200125 PE	125/11.4	100	200	6.10	1.40

(1) Applicable practical values without risk of pipe distortion or damage.

COUPLINGS



Microflex PE-X coupling	Thread
Art. No.	inch
MJ3414432/29	1" M
MJ3415440/37	1 1/4" M
MJ3416450/46	1 1/2" M
MJ341263/58	2" M
MJ34121275/68	2 1/2" M
MJ341390/82	3" M
MJ3414110/100	4" M
MJ3414125/114	4" M

ACCESSORIES

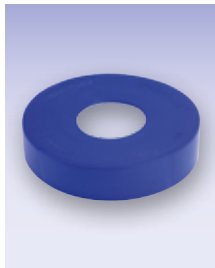

Pipe	Dust cap MS	Shrink cap MK	Rubber End cap EPDM	Couplings MPP	Thread
Art. No	Art. No	Art. No	Art. No	Art. No	inch
M9032 PE	MS9032	MK2100	MG901840	MPP3414432/29	1" M
M9040 PE	MS9040	MK2100	MG901840	MPP3415440/37	1 1/4" M
M12550 PE	MS12550	MK2200	MG1254063	MPP3416450/46	1 1/2" M
M12563 PE	MS12563	MK2400	MG1254063	MPP341263/58	2" M
M16075 PE	MS16075	MK2500	MG1606390	MPP34121275/68	2 1/2" M
M16090 PE	MS16090	MK2500	MG1606390	MPP341390/82	3" M
M200110 PE	MS200110	MK2600	MG20075125	MPP3414110/100	4" M
M200125 PE	MS200125	MK2600	MG20075125		

COLD AND COOLING WATER

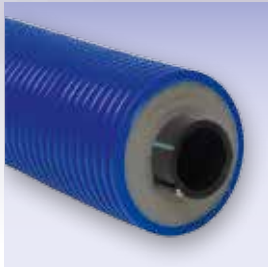

MICROFLEX® COOL with self-regulating heating cable

Single flexible, pre-insulated, self-compensating, underground pipe. Suitable for cold potable water, cooling water and wastewater. Corrosion-resistant transport pipe in PE 100 in accordance with EN 12201. The transport pipe is in contact with a self-regulating heating cable. Thermal, elastic, CFC-free foam insulation made from cross-linked PE-X with closed microcellular structure. Minimal water absorption capacity of < 1% in accordance with ISO 2896. Corrugated outside casing in HDPE, made in accordance with the closed chamber principle to provide high-grade protection to the piping system.

- Max operating pressure: 16 bar
- Max fluid temperature: -10°C ... +25°C
- PE pipes: SDR 11
- Heating cable power: 10 W/m (18W/m in option)
- Standard full coil length: 100 m

Specific combinations?
Please contact us.

WRAS approval

PIPES

	PE d _{out} /s	PE d _{in}	Outside casing d _{out}	Weight	Bending radius (1)
Art. No.	mm	DN	mm	kg/m	m
MV7532 PE	32/2.9	25	75	0.84	0.20
MV9040 PE	40/3.7	32	90	1.20	0.30
MV12550 PE	50/4.6	40	125	2.00	0.40
MV12563 PE	63/5.8	50	125	2.25	0.50
MV16075 PE	75/6.8	65	160	3.30	0.75
MV16090 PE	90/8.2	75	160	3.95	1.00
MV200110 PE	110/10.0	90	200	5.84	1.20
MV200125 PE	125/11.4	100	200	6.10	1.40

(1) Applicable practical values without risk of pipe distortion or damage.

COUPLINGS



Microflex PE-X coupling	Thread
Art. No.	inch
MJ3414432/29	1" M
MJ3415440/37	1 1/4" M
MJ3416450/46	1 1/2" M
MJ341263/58	2" M
MJ34121275/68	2 1/2" M
MJ341390/82	3" M
MJ3414110/100	4" M
MJ3414125/114	4" M

ACCESSORIES

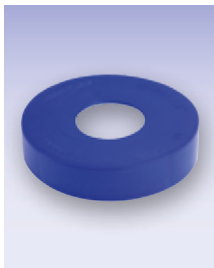

Pipe	Dust cap MS	Shrink cap MK	Rubber End cap EPDM	Couplings MPP	Thread
Art. No.	Art. No.	Art. No.	Art. No.	Art. No.	inch
MV7532 PE	MS7532	MK2100	MG751832	MPP3414432/29	1" M
MV9040 PE	MS9040	MK2100	MG901840	MPP3415440/37	1 1/4" M
MV12550 PE	MS12550	MK2200	MG1254063	MPP3416450/46	1 1/2" M
MV12563 PE	MS12563	MK2400	MG1254063	MPP341263/58	2" M
MV16075 PE	MS16075	MK2500	MG1606390	MPP34121275/68	2 1/2" M
MV16090 PE	MS16090	MK2500	MG1606390	MPP341390/82	3" M
MV200110 PE	MS200110	MK2600	MG20075125	MPP3414110/100	4" M
MV200125 PE	MS200125	MK2600	MG20075125		

MICROFLEX® Connection kit for heating cable

This connection kit is used to connect the heating cable to the Microflex Cool pipes. Contents:

MVTH

An ambient thermostat that interrupts the heating cable depending on changing temperature influences. The use of this thermostat is strongly recommended, because it prevents the heating cable from being live at all times and so cuts energy consumption.

- Operation: automatic / EN 60730-1
- Protection level: IP 54 / EN 60529
- Regulating range: -10°C...+40°C
- Differential: 1 - 2 K
- Switch power: 16A / 230 VAC
- Voltage: 230 VAC

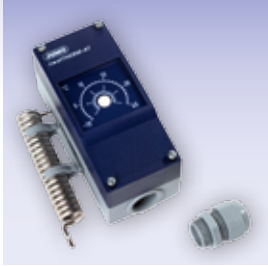

MVBOX

A PVC distribution box in which the heating cable is connected to the current feed.

- Protection level: IP 55



MVKITGR

One kit comprising:

- 3 shrink sleeves to insulate the feed wire and the earthing of the heating cable
- 1 long shrink sleeve to insulate the heating cable at the connection
- 2 short shrink sleeves to insulate the end of the heating cable
- 1 swivel for bulkhead in the MVBOX



Art. No.	Description
MVTH	Ambient thermostat
MVBOX	Distribution box
MVKITGR	Set of insulating shrink sleeves
MVKITM	1 x MVBOX + 2 x MVKITGR
MVKITT	1 x MVBOX + 3 x MVKITGR

The heating cable must be connected to a 230 VAC network. The circuit must be protected with a 16A fuse and a 30mA RCD. We recommend that the trigger ambient temperature must be set to 2°C (by means of the thermostat).

NB:

At a temperature of 0°C the heating cable must not be longer than 100 m. If this length is exceeded, the heating cables must be fed individually.

MVTH + MVBOX + MVKITGR

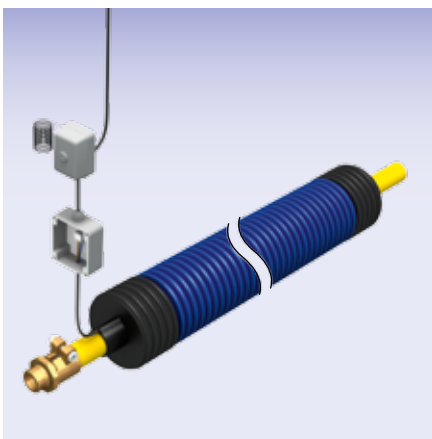

MVKITM

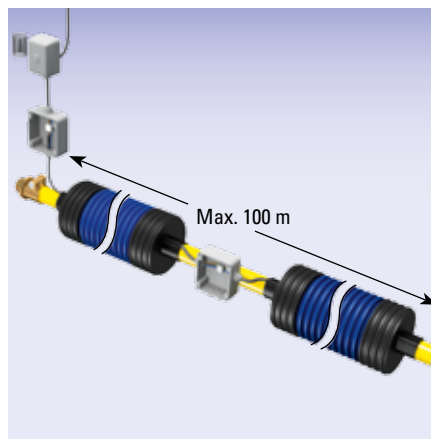

MVKITT

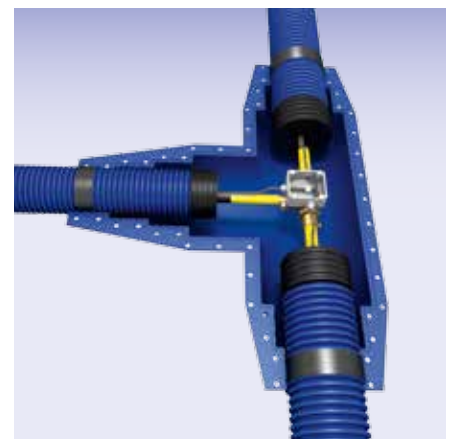

COLD AND COOLING WATER

Heat loss table for MICROFLEX® COOL with self-regulating heating cable

This table shows the heat losses at negative temperatures around the outside casing.
If heat losses exceed 9 Watt/m the pipe is in danger of freezing.

Casing d _{out} Pipe d _{out}	75/25	125/25	75/32	90/32	125/32	90/40	125/40	160/40	125/50	160/50	125/63	160/63	160/75	200/75	160/90	200/90	200/110	200/125
temperature around the outside casing	-1	1	1	1	1	1	1	1	1	1	1	1	1	1	1	1	1	1
	-2	1	1	1	1	1	1	1	1	1	2	1	2	1	2	1	2	2
	-3	1	1	1	1	1	2	1	1	2	1	2	1	2	1	3	2	2
	-4	2	1	2	2	1	2	2	1	2	1	3	2	2	2	3	2	2
	-5	2	1	2	2	1	2	2	1	2	2	3	2	3	2	4	3	3
	-6	2	1	2	2	2	3	2	2	3	2	3	2	3	2	4	3	3
	-7	2	2	2	3	2	3	2	2	3	2	4	2	3	3	5	3	4
	-8	3	2	3	3	2	4	3	2	3	2	4	3	4	3	5	4	4
	-9	3	2	3	3	2	4	3	2	4	3	5	3	4	3	6	4	5
	-10	3	2	3	3	3	4	3	2	4	3	5	4	5	3	6	4	5
	-11	4	2	4	4	3	5	3	3	4	3	6	4	5	4	7	5	6
	-12	4	3	4	4	3	5	4	3	5	3	6	4	5	4	7	5	6
	-13	4	3	4	4	3	5	4	3	5	4	7	4	6	4	8	5	7
	-14	4	3	5	5	3	6	4	3	5	4	7	5	6	5	8	6	7
	-15	5	3	5	5	4	6	4	3	6	4	7	5	6	5	9	6	7
	-16	5	3	5	5	4	6	5	4	6	4	8	5	7	5	9	6	8
	-17	5	3	5	6	4	7	5	4	6	5	8	6	7	5	10	7	8
	-18	5	4	6	6	4	7	5	4	6	5	9	6	8	6	10	7	9
	-19	6	4	6	6	4	8	5	4	7	5	9	6	8	6	10	7	9
	-20	6	4	6	6	5	8	6	4	7	5	9	7	8	6	11	8	10
-21	6	4	7	7	5	8	6	5	7	6	10	7	9	7	11	8	10	
-22	6	4	7	7	5	9	6	5	8	6	10	7	9	7	12	8	10	
-23	7	4	7	7	5	9	6	5	8	6	11	7	9	7	12	9	11	
-24	7	5	8	7	6	9	7	5	8	6	11	8	10	7	13	9	11	
-25	7	5	8	8	6	10	7	5	9	6	12	8	10	8	13	9	12	
-26	7	5	8	8	6	10	7	6	9	7	12	8	10	8	14	10	12	
-27	8	5	8	8	6	10	7	6	9	7	12	8	11	8	14	10	13	
-28	8	5	9	9	6	11	7	6	10	7	13	9	11	9	15	10	13	
-29	8	5	9	9	7	11	8	6	10	7	13	9	12	9	15	11	14	
-30	8	6	9	9	7	11	8	6	10	8	14	9	12	9	16	11	14	
-31	9	6	10	9	7	12	8	6	10	8	14	10	12	9	16	11	15	
-32	9	6	10	10	7	12	8	7	11	8	14	10	13	10	17	12	15	
-33	9	6	10	10	7	12	9	7	11	8	15	10	13	10	17	12	15	
-34	9	6	10	10	8	13	9	7	11	8	15	10	13	10	18	12	16	
-35	10	6	11	10	8	13	9	7	12	9	16	11	14	10	18	13	16	
-36	10	7	11	11	8	13	9	7	12	9	16	11	14	11	18	13	17	
-37	10	7	11	11	8	14	10	8	12	9	16	11	14	11	19	13	17	
-38	10	7	12	11	8	14	10	8	13	9	17	11	15	11	19	14	18	
-39	11	7	12	12	8	14	10	8	13	10	17	12	15	11	20	14	18	
non-recommended temperatures	-40	11	7	12	12	9	15	10	13	10	18	12	15	12	20	14	18	
	-41	11	7	13	12	9	15	10	13	10	18	12	16	12	21	15	19	
	-42	11	8	13	12	9	15	11	14	10	18	13	16	12	21	15	19	
	-43	12	8	13	13	9	16	11	14	10	19	13	16	12	22	15	20	
	-44	12	8	13	13	9	16	11	14	11	19	13	17	13	22	16	20	
	-45	12	8	14	13	10	16	11	14	11	19	13	17	13	23	16	21	
	-46	12	8	14	13	10	17	12	14	11	20	14	17	13	23	16	21	
	-47	13	8	14	14	10	17	12	14	15	11	20	14	18	13	23	16	
	-48	13	9	15	14	10	17	12	15	15	11	21	14	18	14	24	17	
	-49	13	9	15	14	10	17	12	15	16	12	21	14	18	14	24	17	
	-50	13	9	15	14	11	18	12	10	16	12	21	15	19	14	25	17	

SELF-REGULATING HEATING CABLE – STRUCTURE AND OPERATION

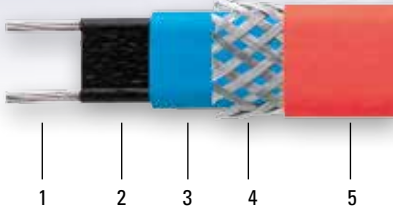

1. Tin-coated copper conductor
2. Self-regulating heating element
3. Electric insulation mantle
4. Safety plait in tin-coated copper
5. External safety cover



Schematic diagram

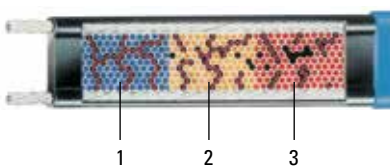
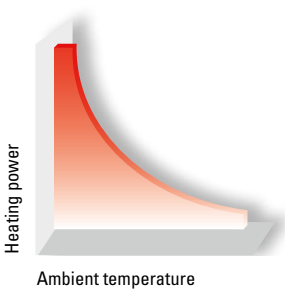

1. In the cold sections of the heating cable, the structure of the plastic will draw together, generating a large number of electrical currents through the carbon particles. The current is converted into heat in the heating element.
2. In the warmer sections, the structure of the plastic expands and progressively interrupts the currents in the carbon particles. This increases the resistance and reduces the current draw and thus the heating capacity.
3. In the hot sections, the expansion of the plastic structure breaks the currents almost entirely. This creates a very high electrical resistance and the heating capacity falls to almost 0.

Robust construction

The heating cable is a self-regulating cable with two parallel, multiwire tin-coated copper conductors and an intermediate semiconducting heating element. This heating element is electrically insulated by means of a synthetic polyolefine or fluoropolymer cover. It is also covered by a plaited, tin-coated copper cord. This plaiting provides the earthing (safety conductor) for the heating cable, complies with prevailing safety standards (VDE 0100) and is fitted with an additional mechanical protection.

Proven lifespan

These self-regulating heating cables have been intensively tested in our laboratories using international standard tests and recognised scientific methods and procedures. These tests found that the self-regulating heating cable has a lifespan of over 40 years.

Licenses

All self-regulating heating cables are manufactured in accordance with the strictest quality norms and are subjected to ongoing quality controls. They are VDE-certified as well as with a variety of production, control and other licenses from many countries.

Parallel circuits

The current flows between two parallel copper conductors, regardless of where the heating cable is and right through the semiconducting, molecularly refined heating element. The electrical circuit diagram is similar to a parallel circuit in many temperature-dependent resistances.

The system's straightforward design and even simpler installation process will save you considerable expense. The heating cable is always connected to a 230 VAC output, regardless of its length.

Operation

The heating element consists of a specially formulated, molecularly refined plastic cover embedded with carbon particles which generate electrical currents between two parallel copper conductors. When the temperature rises, the plastic expands due to molecular expansion.

The carbon particles move further and further apart, resulting in the interruption of the electrical currents and a rise in the electrical resistance of the heating element. The current draw and the heating capacity fall proportionally.

When the element cools, the process is reversed and the heating capacity rises in response to low temperatures. The molecular refinement of the heating element gives it duroplastic properties, making the expansion behaviour at molecular level exactly reproducible, even under fluctuating temperatures. The self-regulating properties of the heating cable are thus incorporated into the material itself.

Thanks to this self-regulation, the heating cable responds to temperature fluctuations along the entire length of the system.

Energy conservation

Because the heating capacity adjusts to local temperatures, energy consumption is always adapting to prevailing requirements. The heating cables therefore save energy and costs through self-regulation.

Safe and reliable

Due to these self-regulating properties, the system cannot overheat or burn through, even if the heating cable overlaps.

MICROFLEX® PE-X COUPLINGS - 6/16 BAR

Straight coupling for use in piping systems equipped with transport pipes for heating, cold or cooling water applications.

The coupling has a long supporting pipe for optimal clamping, a conical outside thread connection and a clamping ring with stainless steel bolt. The included remote plate makes it easier to fit the coupling.

Assembly instructions: see our technical manual.

- Max operating pressure: 6 bar (16 bar)
- Max fluid temperature: +95°C (+25°C)
- PE-Xa and PE pipes: SDR 11
- Supporting pipe material: CW602N
- Clamping ring material: CW602N

PE-X coupling



Microflex PE-X coupling	PE-X d _{out} /s	Thread	Weight
Art. No.	mm	inch	kg
MJ3413425/23	25/2.3	3/4" M	0.22
MJ3414432/29	32/2.9	1" M	0.35
MJ3415440/37	40/3.7	1 1/4" M	0.61
MJ3416450/46	50/4.6	1 1/2" M	0.82
MJ341263/58	63/5.8	2" M	1.39
MJ34121275/68	75/6.8	2 1/2" M	1.80
MJ341390/82	90/8.2	3" M	2.98
MJ3414110/100	110/10.0	4" M	3.77
MJ3414125/114	125/11.4	4" M	4.75

PE-X x PE-X coupling



	PE-X d _{out} /s	PE-X d _{out} x d _{out}	Weight
Art. No.	mm	mm	kg
MJ27025/23	25/2.3	25 x 25	0.35
MJ27032/29	32/2.9	32 x 32	0.45
MJ27040/37	40/3.7	40 x 40	0.80
MJ27050/46	50/4.6	50 x 50	1.35
MJ27063/58	63/5.8	63 x 63	2.10
MJ27075/68	75/6.8	75 x 75	2.90
MJ27090/82	90/8.2	90 x 90	5.10
MJ270110/100	110/10.0	110 x 110	6.90
MJ270125/114	125/11.4	125 x 125	9.95

PE-X x PE-X elbow coupling



	PE-X d _{out} /s	Thread	PE-X d _{out} x d _{out}
Art. No.	mm	inch	mm
MJ9025/23	25/2.3	2 x 3/4"	25 x 25
MJ9032/29	32/2.9	2 x 1"	32 x 32
MJ9040/37	40/3.7	2 x 1 1/4"	40 x 40
MJ9050/46	50/4.6	2 x 1 1/2"	50 x 50
MJ9063/58	63/5.8	2 x 2"	63 x 63
MJ9075/68	75/6.8	2 x 2 1/2"	75 x 75
MJ9090/82	90/8.2	2 x 3"	90 x 90
MJ90110/100	110/10.0	2 x 4"	110 x 110
MJ90125/114	125/11.4	2 x 4"	125 x 125

MICROFLEX® PE-X COUPLINGS - 6/16 BAR

3 x PE-X T-coupling

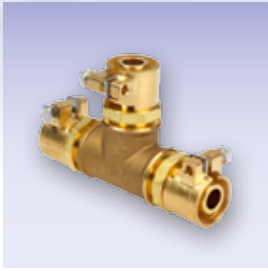

	PE-X d_{out}/s	Thread	PE-X $d_{out} \times d_{out} \times d_{out}$
Art. No.	mm	inch	mm
MJ13025/23	25/2.3	3 x 3/4"	25 x 25 x 25
MJ13032/29	32/2.9	3 x 1"	32 x 32 x 32
MJ1304032/37	40/3.7 + 32/2.9	2 x 1 1/4" + 1 x 1"	40 x 32 x 40
MJ13040/37	40/3.7	3 x 1 1/4"	40 x 40 x 40
MJ1305040/46	50/4.6 + 40/3.7	2 x 1 1/2" + 1 x 1 1/4"	50 x 40 x 50
MJ13050/46	50/4.6	3 x 1 1/2"	50 x 50 x 50
MJ1306350/58	63/5.8 + 50/4.6	2 x 2" + 1 x 1 1/2"	63 x 50 x 63
MJ13063/58	63/5.8	3 x 2"	63 x 63 x 63
MJ13075/68	75/6.8	3 x 2 1/2"	75 x 75 x 75
MJ13090/82	90/8.2	3 x 3"	90 x 90 x 90
MJ130110/100	110/10.0	3 x 4"	110 x 110 x 110
MJ130125/114	125/11.4	3 x 4"	125 x 125 x 125

Weld-end coupling



	PE-X d_{ext}/s	Weld-end d_{ext}	Weld-end d_{int}
N° art.	mm	mm	mm
MJ3412725/23L	25/2.3	26.90	21.50
MJ3413332/29L	32/2.9	33.70	27.00
MJ3414240/37L	40/3.7	42.40	36.00
MJ3414550/46L	50/4.6	48.30	42.00
MJ3415763/58L	63/5.8	60.30	53.00
MJ3417675/68L	75/6.8	76.10	68.00
MJ3418990/82L	90/8.2	88.90	80.00
MJ341110110/10L	110/10.0	114.30	105.00
MJ341114125/114L	125/11.4	114.30	105.00

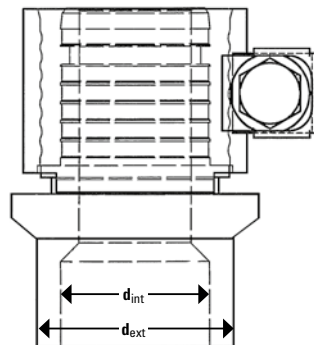

MICROFLEX® PE-X COUPLINGS - 10 BAR

Straight coupling for use in piping systems equipped with transport pipes for sanitary, cold or hot water applications. The coupling has a long supporting pipe for optimal clamping, a conical outside thread connection and a clamping ring with stainless steel bolt. The included remote plate makes it easier to fit the coupling.

Assembly instructions: see our technical manual.

- Max operating pressure: 10 bar
- Max fluid temperature: +95°C
- PE-Xa pipes: SDR 7.4
- Supporting pipe material: CW602N
- Clamping ring material: CW602N

PE-X coupling



Microflex PE-X coupling	PE-X d _{out} /s	Thread	Weight
Art. No.	mm	inch	kg
MJ3413420/28	20/2.8	3/4" M	0.17
MJ3413425/35	25/3.5	3/4" M	0.22
MJ3414432/44	32/4.4	1" M	0.35
MJ3415440/55	40/5.5	1 1/4" M	0.59
MJ3416450/69	50/6.9	1 1/2" M	0.90
MJ341263/87	63/8.7	2" M	1.47
MJ34121275/103	75/10.3	2 1/2" M	1.80
MJ341390/123	90/12.3	3" M	2.98
MJ3414110/151	110/15.1	4" M	3.77

PE-X x PE-X coupling

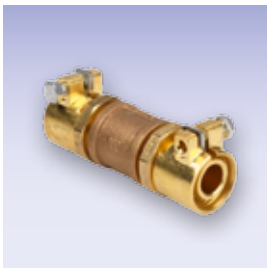

	PE-X d _{out} /s	Thread	PE-X d _{out} x d _{out}
Art. No.	mm	inch	mm
MJ27025/35	25/3.5	2 x 3/4"	25 x 25
MJ27032/44	32/4.4	2 x 1"	32 x 32
MJ27040/55	40/5.5	2 x 1 1/4"	40 x 40
MJ27050/69	50/6.9	2 x 1 1/2"	50 x 50
MJ27063/87	63/8.7	2 x 2"	63 x 63
MJ27075/103	75/10.3	2 x 1 1/2"	75 x 75
MJ27090/123	90/12.3	2 x 3"	90 x 90
MJ270110/151	110/15.1	2 x 4"	110 x 110

PE-X x PE-X elbow coupling



	PE-X d _{out} /s	Thread	PE-X d _{out} x d _{out}
Art. No.	mm	inch	mm
MJ9025/35	25/3.5	2 x 3/4"	25 x 25
MJ9032/44	32/4.4	2 x 1"	32 x 32
MJ9040/55	40/5.5	2 x 1 1/4"	40 x 40
MJ9050/69	50/6.9	2 x 1 1/2"	50 x 50
MJ9063/87	63/8.7	2 x 2"	63 x 63
MJ9075/103	75/10.3	2 x 2 1/2"	75 x 75
MJ9090/123	90/12.3	2 x 3"	90 x 90
MJ90110/151	110/15.1	2 x 4"	110 x 110

3 x PE-X T-coupling



	PE-X d _{out} /s	Thread	PE-X d _{out} x d _{out} x d _{out}
Art. No.	mm	inch	mm
MJ13025/35	25/3.5	3 x 3/4"	25 x 25 x 25
MJ13032/44	32/4.4	3 x 1"	32 x 32 x 32
MJ1304032/55	40/5.5 + 32/4.4	2 x 1 1/4" + 1 x 1"	40 x 32 x 40
MJ13040/55	40/5.5	3 x 1 1/4"	40 x 40 x 40
MJ1305040/69	50/6.9 + 40/5.5	2 x 1 1/2" + 1 x 1 1/4"	50 x 40 x 50
MJ13050/69	50/6.9	3 x 1 1/2"	50 x 50 x 50
MJ1306350/87	63/8.7 + 50/6.9	2 x 2" + 1 x 1 1/2"	63 x 50 x 63
MJ13063/87	63/8.7	3 x 2"	63 x 63 x 63
MJ13075/103	75/10.3	3 x 2 1/2"	75 x 75 x 75
MJ13090/123	90/12.3	3 x 3"	90 x 90 x 90
MJ130110/151	110/15.1	3 x 4"	110 x 110 x 110

ACCESSORIES

Anti-seize copper based lubricant



An anti-seize copper based lubricant, available in a handy stick. Provides a shield against seizing and galling.

	Content
N° art.	kg
LOCTITE8065	0.02

Fix point



Suitable for applications where the ends of pipes need to be anchored. Fix points must be installed to absorb the possible effects of thermal expansion / shrinkage of the PE-Xa transport pipes. The non-application of fix points may result in serious damage.

	Thread
Art. No.	inch
MFP34	3/4" MF
MFP44	1" MF
MFP54	1 1/4" MF
MFP64	1 1/2" MF
MFP2	2" MF
MFP212	2 1/2" MF
MFP3	3" MF
MFP4	4" MF

Sleeve



	Thread
Art. No.	inch
VW27034	3/4" FF
VW27044	1" FF
VW27054	1 1/4" FF
VW27064	1 1/2" FF
VW2702	2" FF
VW270212	2 1/2" FF
VW2703	3" FF
VW2704	4" FF

Elbow piece 90°



	Thread
Art. No.	inch
VW9034	3/4" FF
VW9044	1" FF
VW9054	1 1/4" FF
VW9064	1 1/2" FF
VW902	2" FF
VW90212	2 1/2" FF
VW903	3" FF
VW904	4" FF

ACCESSORIES

T-piece



	Thread
Art. No.	inch
VW13034	3/4" FFF
VW13044	1" FFF
VW13054	1 1/4" FFF
VW13064	1 1/2" FFF
VW1302	2" FFF
VW130212	2 1/2" FFF
VW1303	3" FFF
VW1304	4" FFF

Reducing bush MxF



	Thread
Art. No.	inch
VW2414434	1" M x 3/4" F
VW2415434	1 1/4" M x 3/4" F
VW2415444	1 1/4" M x 1" F
VW2416434	1 1/2" M x 3/4" F
VW2416444	1 1/2" M x 1" F
VW2416454	1 1/2" M x 1 1/4" F
VW241234	2" M x 3/4" F
VW241244	2" M x 1" F
VW241254	2" M x 1 1/4" F
VW241264	2" M x 1 1/2" F
VW24121254	2 1/2" M x 1 1/4" F
VW24121264	2 1/2" M x 1 1/2" F
VW2412122	2 1/2" M x 2" F
VW241344	3" M x 1" F
VW241354	3" M x 1 1/4" F
VW241364	3" M x 1 1/2" F
VW24132	3" M x 2" F
VW2413212	3" M x 2 1/2" F
VW24142	4" M x 2" F
VW2414212	4" M x 2 1/2" F
VW24143	4" M x 3" F

ACCESSORIES

Nipple

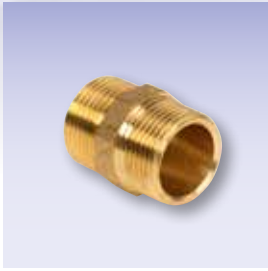

	Thread
Art. No.	inch
VW28034	3/4" M
VW28044	1" M
VW28054	1 1/4" M
VW28064	1 1/2" M
VW2802	2" M
VW280212	2 1/2" M
VW2803	3" M
VW2804	4" M

Plug

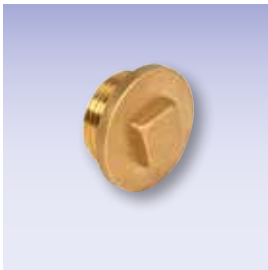

	Thread
Art. No.	inch
VW29034	3/4" M
VW29044	1" M
VW29054	1 1/4" M
VW29064	1 1/2" M
VW2902	2" M
VW290212	2 1/2" M
VW2903	3" M
VW2904	4" M

Ball valve



	Thread
Art. No.	inch
VW35034	3/4" M
VW35044	1" M
VW35054	1 1/4" M
VW35064	1 1/2" M
VW3502	2" M
VW350212	2 1/2" M
VW3503	3" M
VW3504	4" M

Flange

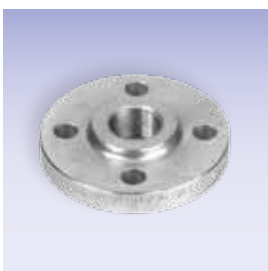

	Thread
Art. No.	inch
MDF34	3/4" F
MDF44	1" F
MDF54	1 1/4" F
MDF64	1 1/2" F
MDF2	2" F
MDF212	2 1/2" F
MDF3	3" F
MDF4	4" F

PLASTIC COUPLINGS FOR PE PIPES

Polypropylene coupling for use in cold and cooling water systems, sea water and chlorine water systems. Suitable for connection to PE transport pipes.

- Max operating pressure at 20°C: 16 bar for 32-63 mm
- Max operating pressure at 20°C: 10 bar for 75-110 mm
- PE pipes: SDR 11
- Material: polypropylene

Male-threaded coupling



	PE d_{out}/s	Thread
Art. No.	mm	inch
MPP3414432/29	32/2.9	1" M
MPP3415440/37	40/3.7	1 1/4" M
MPP3416450/46	50/4.6	1 1/2" M
MPP341263/58	63/5.8	2" M
MPP34121275/68	75/6.8	2 1/2" M
MPP341390/82	90/8.2	3" M
MPP3414110/100	110/10.0	4" M

PE x PE pipe coupling



	PE d_{out}/s	PE $d_{out} \times d_{out}$
Art. No.	mm	mm
MPP27032/29	32/2.9	32 x 32
MPP27040/37	40/3.7	40 x 40
MPP27050/46	50/4.6	50 x 50
MPP27063/58	63/5.8	63 x 63
MPP27075/68	75/6.8	75 x 75
MPP27090/82	90/8.2	90 x 90
MPP270110/100	110/10.0	110 x 110

PE x PE Elbow piece



	PE d_{out}/s	PE $d_{out} \times d_{out}$
Art. No.	mm	mm
MPP9032/29	32/2.9	32 x 32
MPP9040/37	40/3.7	40 x 40
MPP9050/46	50/4.6	50 x 50
MPP9063/58	63/5.8	63 x 63
MPP9075/68	75/6.8	75 x 75
MPP9090/82	90/8.2	90 x 90
MPP90110/100	110/10.0	110 x 110

3 x PE T-piece



	PE d_{out}/s	PE $d_{out} \times d_{out} \times d_{out}$
Art. No.	mm	mm
MPP13032/29	32/2.9	32 x 32 x 32
MPP13040/37	40/3.7	40 x 40 x 40
MPP13050/46	50/4.6	50 x 50 x 50
MPP13063/58	63/5.8	63 x 63 x 63
MPP13075/68	75/6.8	75 x 75 x 75
MPP13090/82	90/8.2	90 x 90 x 90
MPP130110/100	110/10.0	110 x 110 x 110

ACCESSORIES OUTSIDE CASING

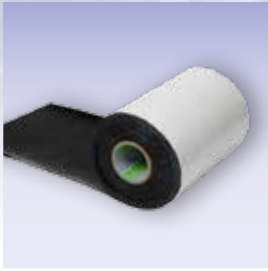

Repair tape

Used to repair incidental local damage to the outside casing.
 MHB200: Heat-shrinkable wrapping tape
 MHK150: Cold-applied wrapping tape

	Repair tape	L x W
Art. No.		m
MHB200	Heat-shrinkable tape	10 x 0.20
MHK150	Cold-applied tape	10 x 0.15



Shrink sleeve

Used to repair incidental local damage to the outside casing. Slide the sleeve over the damaged area, heat with hot air (be sure not to burn the outside casing) and apply gentle pressure wearing protective gloves.

	Outside casing d_{out}	Width
Art. No.	mm	mm
MHM75/90	75 - 90	220
MHM125	125	220
MHM160	160	220
MHM200	200	220

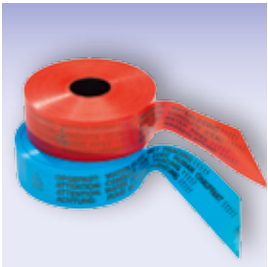

Warning tape

Used to show the location of underground pipes during excavation work. The tape is placed in the trenches above the pre-insulated pipe.

	Warning tape	L x W
Art. No.		m
MTRW	Attention: water pipe (red)	250 x 0.08
MTRB	Attention: water pipe with heating cable (blue)	250 x 0.08

WALL FEED-THROUGHS



MICRO SEAL (for pressurised water)

This pressurised water-impermeable wall seal can be applied directly in drilled holes and bricked-up, plastic and fibre cement wall feed-throughs. The Micro Seal chain comprises a number of links that expand when tightened to produce a very tight seal.



Drill a hole according to minimum and maximum dimensions (see column wall opening).

Apply the Micro Seal chain around the outer jacket. Make sure that a straight line of at least 60 cm is maintained before and after the belt. Bends are not allowed.

Slide the pipe with Micro Seal chain into the wall opening.

By tightening the bolts of the evenly spaced links, the pressure plates are uniformly compressed, filling the annular space between the pipe and the wall opening.

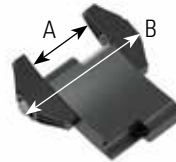

Art. No.	Outside casing d_{out} mm	Micro Seal size		Wall opening mm	Torque Nm
		Rubber A mm	Length bolts B mm		Max. Nm
9LS200	75	43	75	100 - 102	2
7LS300	75	62	100	110 - 115	6
8LS300	90	62	100	128 - 132	6
9LS315	90	62	100	134 - 136	6
7LS475	125	84	135	194 - 210	20
6LS325	125	65	125	175 - 180	6
7LS325	160	65	125	209 - 212	6
7LS400	160	86	135	240 - 245	20
13LS300	160	62	100	200 - 202	6
9LS325	200	65	125	250 - 255	6
8LS400	200	86	135	275 - 282	20
10LS575	200	96	145	301 - 320	50

WALL FEED-THROUGHS

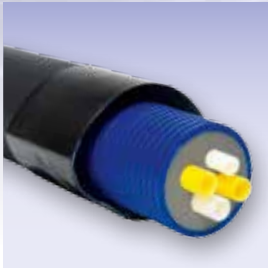

MMDV Wall feed-through (for non-pressurised water)

The MMDV wall feed-through comprises a profiled HDPE pipe and shrink sleeve. After the pipe is bricked in (protruding 10 cm out of the wall), the Microflex pipe is fed through and sealed with the shrink sleeve. The minimum wall thickness is 40 cm.



	Microflex pipe with casing d_{out}	Wall feed-through pipe d_{out}	Wall hole
Art. No.	mm	mm	mm
MMDV75/90	75/90	110	210
MMDV125	125	160	260
MMDV160	160	200	300
MMDV200	200	235	350

UNDERGROUND INSULATION KITS



Inspection chamber

Used to connect Uno, Duo and Quadro pipes. The HDPE inspection chamber has 6 connection points, enables connections of different pipes and integration of shut off valves. Kit comprises inspection chamber, lid, stainless steel bolts, sealer kit and assembly instructions.

	Microflex pipe with casing d_{out}	Diameter MIS	H	Weight
Art. No.	mm	mm	mm	kg
MIS	200/160/125	810	770	35

Heat shrinkable caps to be ordered separately!

Shrink sleeve for use with inspection chamber

	Outside casing d_{out}	Length
Art. No.	mm	mm
MHM125	125	220
MHM160	160	220
MHM235	200	220

UNDERGROUND INSULATION KITS

Assembly instructions: see our technical manual.

Insulated T-piece kit

Guarantees complete insulation and sealing of branch connections between Uno, Duo and Quadro pipes. Kit comprises 2 halves in HDPE, rock wool insulation, sealer kit, stainless steel bolts and assembly instructions.



	Microflex pipe with casing d_{out}	L	W	H	Weight
Art. No.	mm	mm	mm	mm	kg
MT129075	125/90/75	960	590	200	5.5
MT201612	200/160/125	1170	750	270	8.0

Heat shrinkable caps to be ordered separately!

Insulated double T-piece kit

Guarantees complete insulation and sealing of branch connections between Uno, Duo and Quadro pipes. Kit comprises 2 halves in HDPE, rock wool insulation, sealer kit, stainless steel bolts and assembly instructions.



	Microflex pipe with casing d_{out}	L	W	H	Weight
Art. No.	mm	mm	mm	mm	kg
MDT201612	200/160/125	1200	1200	270	14

Heat shrinkable caps to be ordered separately!

Reduction for insulated T-piece kit MT201612 and MDT201612

Used where the difference in diameter at a transition is too big. Reductions comprise an outside casing with interior insulation and a shrink sleeve. The reduction is pressed into the insulated T-piece kit.

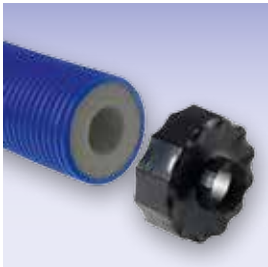

Art. No.	Description
MR24116075	160 to 75 / 90 reduction

Insulated I-piece kit

Guarantees complete insulation and sealing of straight extensions of Uno, Duo and Quadro pipes. Kit comprises 2 halves in HDPE, rock wool insulation, sealer kit, stainless steel bolts and assembly instructions.



	Microflex pipe with casing d_{out}	L	W	H	Weight
Art. No.	mm	mm	mm	mm	kg
MM129075	125/90/75	960	290	200	4.5
MM201612	200/160/125	1170	345	270	5.5

Heat shrinkable caps to be ordered separately!

UNDERGROUND INSULATION KITS



Insulation kit I variant

Guarantees complete insulation and sealing of straight extensions of Uno, Duo and Quadro pipes. Kit comprises a smooth black HDPE pipe, rock wool insulation, 2 shrink sleeves, adhesive tape and assembly instructions.

	Microflex pipe with casing d_{out}	L	MM insulation kit d_{out}	Weight
Art. No.	mm	mm	mm	kg
MM75/90	75/90	700	110	1.8
MM125	125	850	140	2.5
MM160	160	1000	180	4.0
MM200	200	1000	225	6.0

Heat shrinkable caps to be ordered separately!



Insulated elbow 90° kit

Guarantees complete insulation and sealing of perpendicular connections between Uno, Duo and Quadro pipes. Kit comprises 2 halves in HDPE, rock wool insulation, sealer kit, stainless steel bolts and assembly instructions.

	Microflex pipe with casing d_{out}	L	W	H	Weight
Art. No.	mm	mm	mm	mm	kg
MH201612	200/160/125	740	740	270	7.5

Heat shrinkable caps to be ordered separately!

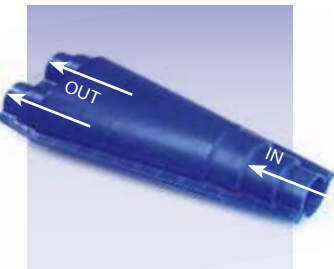

Insulated Y-connection kit

Guarantees complete insulation and sealing of straight extensions between 1 Quadro and 2 Duo or 1 Duo to 2 Uno pipes. Kit comprises 2 halves in HDPE, rock wool insulation, sealer kit, stainless steel bolts and assembly instructions.

	Microflex pipe with casing d_{out}	L	W	H	Weight
Art. No.	mm	mm	mm	mm	kg
MBR201612	200/160/125	1170	460	230	7.0
IN	200/160/125				
OUT	160/125				

Heat shrinkable caps to be ordered separately!

Mediumpipes PE-Xa / PEHD

Worldwide Approvals Selection

 Belgian Standard Institute Approva	 Sddeutsches Kunststoff-Zentrum Amtlich anerkannte Prüfanstalt für Kunststoffe GERMANY
 Danish Technical Institute for Building Purposes Approvals (Ind. drinking water approval)	 Deutscher Verein des Gas-und Wasserfaches e.V. (Incl. drinking water approval)
 International ISO 9001 Approval	 America Standard Food Approval For Drinking Water
 UK Drinking Water Approval	 Swedish Standard Institute Approval
 Dutch Standard Institute Approval	France Avis Technique n° 14/11-1690
 Russian Standard Institute Approval	 Centre Scientifique et Technique du bâtiment  Attestion de Conformité Sanitaire

Other certificats on request

INSTALLATION GUIDELINES

Examples of connections

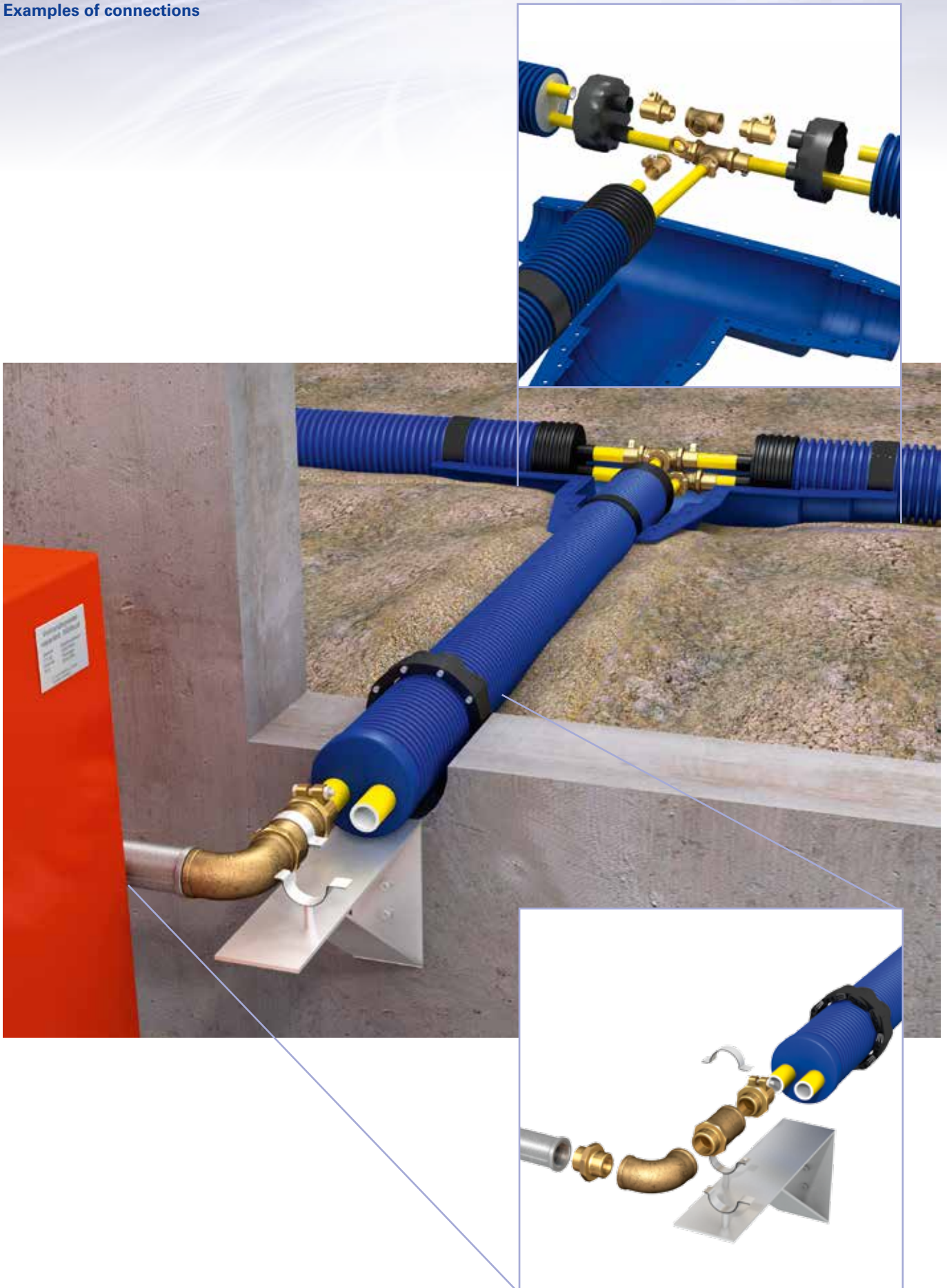

INSTALLATION GUIDELINES



Installation time

The installation time is highly dependant on local conditions. Obstacles, use of tools and weather can have a significant impact on the installation.

Outside casing d_{out}	PE(X-a) d_{out}	Time	Number of workers
mm	mm	minutes *	
UNO (100 m)			
75	25	40	3
90	32	40	3
90/125/160	40	60	3
125/160	50	60	3
125/160	63	60	4
160/200	75	75	4
160/200	90	90	5
200	110	90	5
200	125	90	6
DUO (100 m)			
125/160	25	40	3
125/160	32	40	3
160	40	60	3
160/200	50	60	3
200	63	60	4
QUADRO (100 m)			
160	25	60	4

* All installation times are approximate. Transport and digging not included.



Accessories

	Time	Number of workers
	minutes *	
Terminal connections PE-X/PE-X up to DN 50	15 min.	1
Terminal connections PE-X/PE-X from DN 63 up to DN 100	20 min.	1
Tees PE-X up to DN 50	30 min.	1
Tees PE-X from DN 63 up to DN 100	40 min.	1
Insulation casings Ø 125 – 200 type MM/MH	20 min.	1
Insulation casings Ø 125 – 200 type MT/MBR	30 min.	1
Shrink caps Ø 125 – 200 mm	15 min.	1

* All installation times are approximate. Transport and digging not included.



Coil sizes

Outside casing d_{out}	Microflex pipes							
	20 m		50 m		75 m		Full coil	
mm	w (m)	d (m)	w (m)	d (m)	w (m)	d (m)	w (m)	d (m)
75	0.25	1.55	0.25	1.85	0.30	2.00	0.30	2.10
90	0.25	1.55	0.35	1.85	0.40	2.10	0.50	2.10
125	0.25	1.75	0.40	2.10	0.56	2.10	0.70	2.10
160	0.40	1.90	0.55	2.20	0.70	2.35	0.80	2.35
200	0.50	2.00	0.80	2.30	1.15	2.35	1.40	2.35

INSTALLATION GUIDELINES

Groundwork



The Microflex pipes are laid in trenches in the ground. It is most practical to lay the excavated ground alongside the trench. The following steps can be performed from the other side:

- Position the roll alongside the trench
- Remove the packaging foil
- Place the end of the pipe in position
- Cut the outermost straps
- Roll the pipe alongside or straight into the trench
- Cut the middle straps
- Roll out further
- Cut the innermost straps
- Roll out completely
- Apply the dust caps or shrink caps
- Connect the couplings on the pipes
- Conduct the pressure test – fill in the report
- Partially fill the trench with a first layer
- Apply the warning tape
- Fill up the trench completely



The following guidelines should be followed during pipe installation:

- Lay the pipes in a bed of sand
- Avoid damaging the casing, remove sharp objects from the ground
- Always grasp the transport pipe and not the outer tube
- Keep to the stated bending radii
- Lay the line in a serpentine course
- The code of good craftsmanship for installing underground pipes must be observed. Read our installation instructions
- Sketch how and where the pipe network runs on a plan (including branches and connections), which you should keep

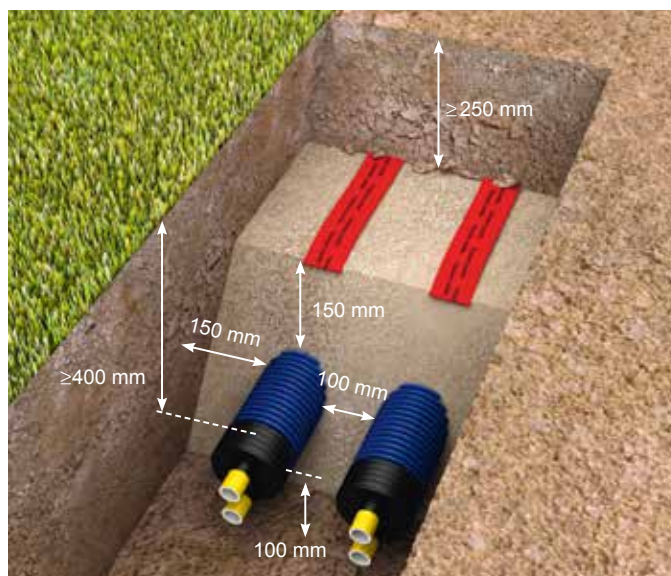

A Microflex pipe buried at a depth of no less than 50 cm and no more than 6 metres can bear a load of up to 60 tonnes. Placement must be performed in compliance with the prevailing ATV-DVWK-A127 guidelines for buried pipes.

HEAT LOSS

Heat loss tables

The use of PE-X pipes has proved successful for years in many installations worldwide. Data in the tables reflect principal standards and directives that have been established for cross-linked PE-X pipes by competent national and international authorities.

The values used in calculating the heat loss charge are:

λ Insulation: 0.036 W/m.K at 10°C
0.040 W/m.K at 40°C

λ Ground: 1 W/m.K

λ PE-Xa pipe: 0.35 W/m.K

Depth of cover over top of pipe: 80 cm

With the ΔT being calculated, the heat loss per metre of piping can easily be read along the corresponding line of the table.

For UNO

$$\Delta T = T_v - T_o$$

T_v : Flow temperature

T_o : Ground temperature

For DUO

$$\Delta T = \frac{(T_v + T_r)}{2} - T_o$$

T_v : Flow temperature

T_r : Return temperature

T_o : Ground temperature

MICROFLEX® UNO range

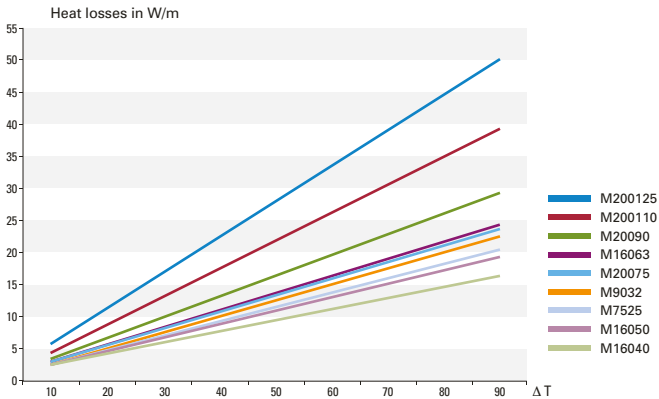

MICROFLEX® DUO range

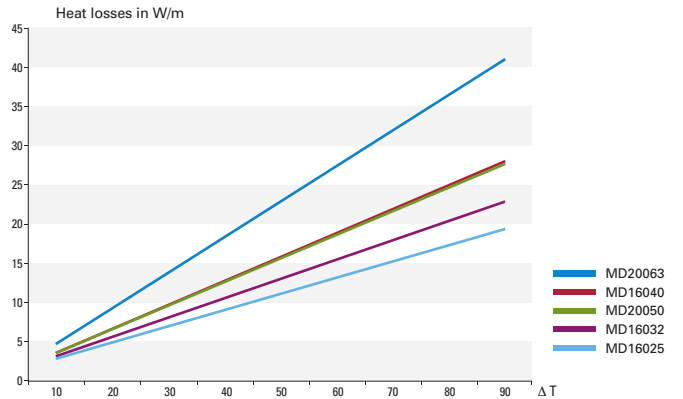

MICROFLEX® PRIMO UNO range

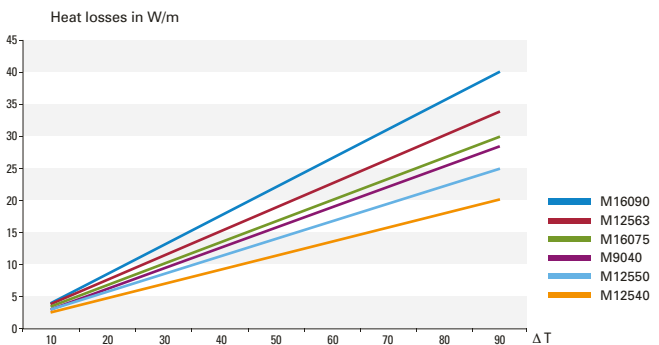

MICROFLEX® PRIMO DUO range

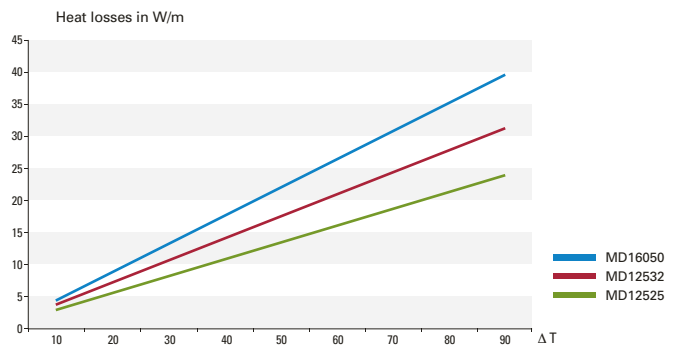

PRESSURE LOSS

Heating capacity in Watts calculated at a ΔT of 20°C

Pipe rugosity: 0,007 mm

Water density: 0.97190 g/cm3

Water temperature: 80°C

		PE-Xa Pipe										PE-Xa Pipe			
		25 x 2,3		32 x 2,9		40 x 3,7				50 x 4,6		63 x 5,8			
l/s	Δt : 20°C Kw	v m/s	R Pa/m	v m/s	R Pa/m	v m/s	R Pa/m	l/s	Δt : 20°C Kw	v m/s	R Pa/m	v m/s	R Pa/m		
1	2	5	6	7	8	9	10	11	12	13	14	15	16		
0,030	2,5	0,09	7,5	-	-	-	-	0,100	8,4	0,08	2,3	0,05	0,7		
0,035	2,9	0,11	9,8	-	-	-	-	0,150	12,6	0,11	4,6	0,07	1,5		
0,040	3,3	0,12	12,3	-	-	-	-	0,200	16,7	0,15	7,6	0,10	2,5		
0,045	3,8	0,14	15,1	-	-	-	-	0,250	20,9	0,19	11,2	0,12	3,7		
0,050	4,2	0,16	18,2	0,09	5,5	-	-	0,300	25,1	0,23	15,5	0,14	5,0		
0,055	4,6	0,17	21,5	0,10	6,5	-	-	0,350	29,3	0,27	20,4	0,17	6,6		
0,060	5,0	0,18	25,0	0,11	7,6	-	-	0,400	33,5	0,31	25,9	0,19	8,4		
0,065	5,4	0,20	28,7	0,12	8,7	-	-	0,450	37,7	0,34	31,9	0,22	10,3		
0,070	5,9	0,21	32,7	0,13	9,9	-	-	0,500	41,9	0,38	38,6	0,24	12,5		
0,075	6,3	0,23	36,9	0,14	11,2	0,09	4,0	0,550	46,1	0,42	45,8	0,26	14,8		
0,080	6,7	0,24	41,4	0,15	12,5	0,10	4,4	0,600	50,2	0,46	53,5	0,29	17,3		
0,085	7,1	0,26	46,0	0,16	13,9	0,10	4,9	0,650	54,4	0,50	61,8	0,31	19,9		
0,090	7,5	0,28	50,9	0,17	15,4	0,11	5,4	0,700	58,6	0,54	70,7	0,33	22,8		
0,095	7,9	0,29	56,0	0,18	16,9	0,11	6,0	0,750	62,8	0,57	80,1	0,36	25,8		
0,100	8,4	0,31	61,4	0,19	18,5	0,12	6,5	0,800	66,9	0,61	90,0	0,38	28,9		
0,120	10,0	0,37	84,8	0,22	25,6	0,14	9,0	0,850	71,2	0,65	100,4	0,41	32,3		
0,140	11,7	0,43	111,5	0,26	33,6	0,17	11,8	0,900	75,4	0,69	111,4	0,43	35,8		
0,160	13,4	0,49	141,6	0,30	42,5	0,19	14,9	0,950	79,5	0,73	122,9	0,45	39,4		
0,180	15,1	0,55	174,9	0,33	52,4	0,22	18,4	1,000	83,7	0,76	134,9	0,48	43,2		
0,200	16,7	0,61	211,3	0,37	63,2	0,24	22,1	1,050	87,9	0,80	147,4	0,50	47,2		
0,220	18,4	0,67	250,9	0,41	74,9	0,26	26,2	1,100	92,1	0,84	160,5	0,53	51,4		
0,240	20,1	0,73	295,3	0,45	87,5	0,29	30,6	1,150	96,3	0,88	174,0	0,55	55,7		
0,260	21,8	0,80	339,3	0,48	101,0	0,31	35,3	1,200	100,5	0,92	188,1	0,57	60,1		
0,280	23,4	0,86	388,1	0,52	115,4	0,34	40,3	1,250	104,7	0,96	202,7	0,60	64,7		
0,300	25,1	0,92	439,9	0,56	130,7	0,36	45,5	1,300	108,9	0,99	217,8	0,62	69,5		
0,320	26,8	0,98	494,7	0,59	146,8	0,38	51,1	1,350	113,0	1,03	233,4	0,65	74,4		
0,340	28,5	1,04	552,4	0,63	163,7	0,41	57,0	1,400	117,2	1,07	249,5	0,67	79,5		
0,360	30,1	1,10	613,2	0,67	181,5	0,43	63,1	1,450	121,4	1,11	266,1	0,69	84,8		
0,380	31,8	1,16	676,9	0,70	200,2	0,46	69,5	1,500	125,6	1,15	283,2	0,72	90,2		
0,400	33,5	1,22	743,5	0,74	219,6	0,48	76,3	1,550	129,8	1,19	300,8	0,74	95,7		
0,420	35,2	1,28	813,1	0,78	240,0	0,50	83,2	1,600	133,9	1,22	318,8	0,77	101,4		
0,440	36,8	1,35	885,6	0,82	261,1	0,53	90,5	1,650	138,2	1,26	337,4	0,79	107,3		
0,460	38,5	1,41	961,0	0,85	283,1	0,55	98,1	1,700	142,4	1,30	356,5	0,81	113,3		
0,480	40,2	1,47	1.039,3	0,89	305,8	0,58	105,9	1,750	146,5	1,34	376,1	0,84	119,4		
0,500	41,9	1,53	1.120,5	0,93	329,4	0,60	114,0	1,800	150,7	1,38	396,2	0,86	125,8		
0,550	46,1	1,68	1.336,0	1,02	392,0	0,66	135,4	1,900	159,1	1,45	437,8	0,91	138,8		
0,600	50,2	1,84	1.569,5	1,11	459,6	0,72	158,6	2,000	167,5	1,53	481,3	0,96	152,5		
0,650	54,4	1,99	1.820,8	1,21	532,2	0,78	183,4	2,100	175,8	1,61	526,9	1,00	166,8		
0,700	58,6	-	-	1,30	609,8	0,84	209,8	2,200	184,2	1,68	574,3	1,05	181,6		
0,750	62,8	-	-	1,39	692,3	0,90	237,9	2,300	192,6	1,76	623,8	1,10	197,1		
0,800	66,9	-	-	1,48	779,8	0,96	267,7	2,400	200,9	1,84	675,1	1,15	213,1		
0,850	71,2	-	-	1,58	872,2	1,02	299,0	2,500	209,3	1,91	728,4	1,20	229,8		
0,900	75,4	-	-	1,67	969,4	1,08	332,0	2,600	217,7	1,99	783,6	1,24	247,0		
0,950	79,5	-	-	1,76	1.071,5	1,14	366,6	2,700	226,1	-	-	1,29	264,8		
1,000	83,7	-	-	1,85	1.178,5	1,20	402,8	2,800	234,5	-	-	1,34	283,2		
1,050	87,9	-	-	1,95	1.290,3	1,26	440,6	2,900	242,8	-	-	1,39	302,2		
1,100	92,1	-	-	2,04	1.406,9	1,32	480,0	3,000	251,2	-	-	1,43	321,8		
1,150	96,3	-	-	-	-	1,38	521,0	3,100	259,6	-	-	1,48	341,9		
1,200	100,5	-	-	-	-	1,44	563,5	3,200	268,0	-	-	1,53	362,6		
1,250	104,7	-	-	-	-	1,50	607,6	3,300	276,3	-	-	1,58	383,9		
1,300	108,9	-	-	-	-	1,56	653,3	3,400	284,7	-	-	1,63	405,8		
1,350	113,0	-	-	-	-	1,62	700,6	3,500	293,1	-	-	1,67	428,2		
1,400	117,2	-	-	-	-	1,68	749,4	3,600	301,4	-	-	1,72	451,2		
1,450	121,4	-	-	-	-	1,74	799,8	3,700	309,8	-	-	1,77	474,8		
1,500	125,6	-	-	-	-	1,80	851,7	3,800	318,2	-	-	1,82	498,9		
1,550	129,8	-	-	-	-	1,86	905,2	3,900	326,6	-	-	1,86	523,7		
1,600	133,9	-	-	-	-	1,92	960,3	4,000	334,9	-	-	1,91	549,0		
1,650	138,2	-	-	-	-	1,98	1.016,9	4,100	343,3	-	-	1,96	574,8		
1,700	142,4	-	-	-	-	2,04	1.075,0	4,200	351,7	-	-	-	-		

Conversion : 1 Watt = 0,860 kCal

PRESSURE LOSS

		PE-Xa Pipe						PE-Xa Pipe					
		75 x 6,8		90 x 8,2				110 x 10,0		125 x 11,4		160 x 14,6	
l/s	Δt : 20°C Kw	v m/s	R Pa/m	v m/s	R Pa/m	l/s	Δt : 20°C Kw	v m/s	R Pa/m	v m/s	R Pa/m	v m/s	R Pa/m
17	18	19	20	21	22	23	24	25	26	27	28	29	30
0,30	25,1	0,10	2,2	0,07	0,9	2,00	167,4	0,31	10,3	-	-	-	-
0,35	29,3	0,12	2,9	0,08	1,2	2,40	200,9	0,38	14,3	-	-	-	-
0,40	33,5	0,14	3,7	0,09	1,5	2,80	234,4	0,44	18,9	-	-	-	-
0,45	37,7	0,15	4,5	0,11	1,9	3,20	267,9	0,50	24,1	-	-	-	-
0,50	41,9	0,17	5,4	0,12	2,3	3,60	301,4	0,57	29,8	-	-	-	-
0,55	46,0	0,19	6,4	0,13	2,7	4,00	334,9	0,63	36,2	-	-	-	-
0,60	50,2	0,20	7,5	0,14	3,1	4,40	368,4	0,69	43,0	0,55	25,0	-	-
0,65	54,4	0,22	8,6	0,15	3,6	4,80	401,9	0,75	50,5	0,58	28,0	-	-
0,70	58,6	0,24	9,9	0,16	4,1	5,20	435,3	0,82	58,4	0,62	33,0	-	-
0,75	62,8	0,25	11,2	0,18	4,7	5,60	468,8	0,88	66,9	0,69	39,0	-	-
0,80	66,9	0,27	12,5	0,19	5,2	6,00	502,3	0,94	76,0	0,73	42,0	-	-
0,85	71,2	0,29	14,0	0,20	5,8	6,40	535,8	1,01	85,6	0,75	46,0	-	-
0,90	75,3	0,30	15,5	0,21	6,5	6,80	569,3	1,07	95,7	0,84	53,0	-	-
0,95	79,5	0,32	17,0	0,22	7,1	7,20	602,8	1,13	106,3	0,87	58,0	-	-
1,00	83,7	0,34	18,7	0,24	7,8	7,50	627,9	1,18	114,6	0,91	62,0	-	-
1,05	87,9	0,35	20,4	0,25	8,5	8,00	669,8	1,26	129,2	0,98	71,0	0,60	24,0
1,10	92,1	0,37	22,2	0,26	9,3	8,40	703,3	1,32	141,4	1,02	75,0	0,62	25,0
1,15	96,3	0,39	24,0	0,27	10,0	8,80	736,7	1,38	154,1	1,08	83,0	0,65	27,0
1,20	100,5	0,41	25,9	0,28	10,8	9,20	770,2	1,45	167,4	1,13	90,0	0,69	30,0
1,30	108,8	0,44	30,0	0,31	12,5	9,40	786,9	1,48	174,2	1,15	93,0	0,71	31,0
1,40	117,2	0,47	34,3	0,33	14,3	9,60	803,7	1,51	181,1	1,17	96,0	0,73	33,0
1,50	125,6	0,51	38,8	0,35	16,2	9,80	820,5	1,54	188,2	1,20	101,0	0,74	34,0
1,60	133,9	0,54	43,6	0,38	18,2	10,00	837,2	1,57	195,4	1,24	106,0	0,76	35,0
1,70	142,3	0,57	48,7	0,40	20,3	10,50	879,1	1,65	214,0	1,29	114,0	0,79	37,0
1,80	150,7	0,61	54,0	0,42	22,5	11,00	920,9	1,73	233,4	1,34	123,0	0,82	40,0
1,90	159,1	0,64	59,6	0,45	24,8	11,50	962,8	1,81	253,5	1,40	132,0	0,85	43,0
2,00	167,4	0,68	65,4	0,47	27,2	12,00	1.004,7	1,89	274,5	1,46	141,0	0,89	46,0
2,10	175,8	0,71	71,5	0,49	29,7	12,50	1.046,5	1,96	296,3	1,53	154,0	0,93	51,0
2,20	184,2	0,74	77,9	0,52	32,3	13,00	1.088,4	2,04	318,8	1,60	166,0	0,98	55,0
2,30	192,6	0,78	84,4	0,54	35,0	13,50	1.130,2	-	-	1,65	177,0	1,01	58,0
2,40	200,9	0,81	91,3	0,56	37,9	14,00	1.172,1	-	-	1,71	187,0	1,05	62,0
2,50	209,3	0,84	98,3	0,59	40,8	14,50	1.213,9	-	-	1,77	197,0	1,08	65,0
2,60	217,7	0,88	105,7	0,61	43,8	15,00	1.255,8	-	-	1,82	208,0	1,11	69,0
2,70	226,0	0,91	113,2	0,63	46,9	15,50	1.297,7	-	-	1,89	223,0	1,16	73,0
2,80	234,4	0,95	121,0	0,66	50,1	16,00	1.339,5	-	-	1,97	238,0	1,20	78,0
2,90	242,8	0,98	129,1	0,68	53,4	16,50	1.381,4	-	-	2,00	251,0	1,23	82,0
3,00	251,2	1,01	137,4	0,71	56,8	17,00	1.423,3	-	-	2,04	264,0	1,27	87,0
3,20	267,9	1,08	154,7	0,75	63,9	17,50	1.465,1	-	-	2,11	275,0	1,30	90,0
3,40	284,7	1,15	172,9	0,80	71,4	18,00	1.506,9	-	-	2,18	286,0	1,33	94,0
3,60	301,4	1,22	192,2	0,85	79,3	18,50	1.548,8	-	-	-	-	1,38	100,0
3,80	318,1	1,28	212,3	0,89	87,6	19,00	1.590,7	-	-	-	-	1,42	106,0
4,00	334,9	1,35	233,4	0,94	96,2	19,50	1.632,6	-	-	-	-	1,45	110,0
4,20	351,6	1,42	255,5	0,99	105,3	20,00	1.674,4	-	-	-	-	1,49	114,0
4,40	368,4	1,49	278,5	1,03	114,7	20,50	1.716,3	-	-	-	-	1,52	119,0
4,60	385,1	1,55	302,4	1,08	124,4	21,00	1.758,1	-	-	-	-	1,56	124,0
4,80	401,9	1,62	327,3	1,13	134,6	21,50	1.800,0	-	-	-	-	1,60	130,0
5,00	418,6	1,69	353,1	1,18	145,1	22,00	1.841,9	-	-	-	-	1,64	136,0
5,20	435,3	1,76	379,8	1,22	156,0	22,50	1.883,7	-	-	-	-	1,67	141,0
5,40	452,1	1,82	407,5	1,27	167,3	23,00	1.925,0	-	-	-	-	1,71	146,0
5,60	468,8	1,89	436,1	1,32	178,9	24,00	2.000,0	-	-	-	-	1,79	158,0
5,80	485,6	1,96	465,6	1,36	190,9	25,00	2.100,0	-	-	-	-	1,87	170,0
6,00	502,3	2,03	496,0	1,41	203,3	26,00	2.180,0	-	-	-	-	1,93	180,0
6,20	519,1	2,09	527,4	1,46	216,0	27,00	2.270,0	-	-	-	-	2,00	191,0
6,40	535,8	2,16	559,6	1,50	229,1	28,00	2.350,0	-	-	-	-	2,09	207,0
6,60	552,6	2,23	592,8	1,55	242,6	29,00	2.430,0	-	-	-	-	2,15	219,0
6,80	569,3	2,30	626,9	1,60	256,5	30,00	2.500,0	-	-	-	-	2,22	231,0
7,00	586,0	2,36	661,9	1,65	270,7	-	-	-	-	-	-	-	-
7,20	602,8	2,43	697,9	1,69	285,2	-	-	-	-	-	-	-	-
7,40	619,5	2,50	734,7	1,74	300,2	-	-	-	-	-	-	-	-

Conversion : 1 Watt = 0,860 kcal

PRESSURE TEST

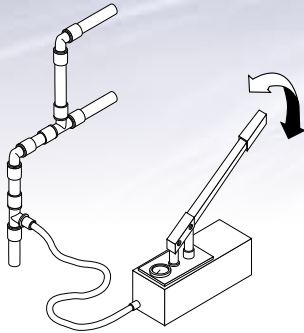

Pressure test according to DIN 1988 - 2

The pressure test procedure is obligatory before closing the trench! The report of this test, fully completed and signed, has to be send to our production plant.

1. Pressure tests

Pressure tests constitute contractually agreed auxiliary work essential to the accomplishment of the contract and also form part of the contractor's performance without being stated in the performance specification. Prior to concealing, fill the finished pipework with water, taking care to avoid air locks. The pressure test must be conducted in two parts, starting with the preliminary test, followed by the main test.

2. Preliminary test

The preliminary test involves applying a test pressure equal to 1.5 times the admissible operating pressure. This pressure must be regenerated twice within the space of 30 minutes at intervals of 10 minutes. Following a test period of another 30 minutes, the test pressure must not have fallen by more than 0,6 bar. Leakages must not occur at any points in the system being tested.

3. Main test

The main test has to be conducted immediately after the preliminary test. The test takes 2 hours. At the end of this period, the test pressure recorded after the preliminary test must not have fallen by more than 0.2 bar. Leakages must not occur at any point in the system being tested.

Leakage testing - DIN 1988 - 2

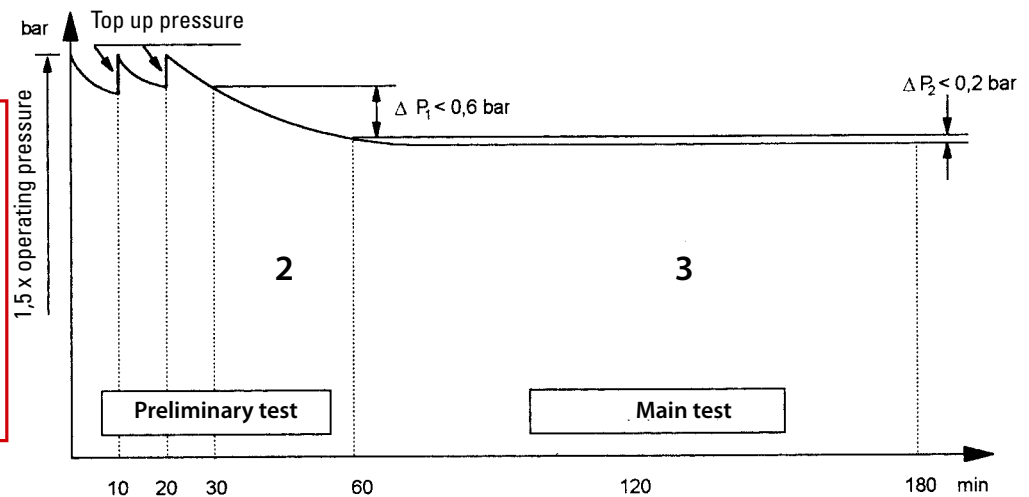

In order to validate the pressure test, send the report to:

WATTS INDUSTRIES S.r.l.
Via Vienna 3
I-38121 GARDOLO
ITALIA

Fax: +39 0461 96 55 50
Mail: microflex@wattswater.com

Test the finished pipe-work before concealing! The state-of-the-art execution and documentation of the pressure test for the entire piping system is a warranty requirement!

	bar / psi		bar / psi
2 Preliminary test	<input type="text"/>	3 Main test	<input type="text"/>
2.1 Operating pressure x 1.5	<input type="text"/>	3.1.1 Beginning	<input type="text"/>
2.2 After 10 min (restore 2.1)	<input type="text"/>	3.1.2 End	<input type="text"/>
2.3 After 20 min (restore 2.1)	<input type="text"/>	3.2 Test pressure	<input type="text"/>
2.4 After 30 min	<input type="text"/>	3.3 After 120 min	<input type="text"/>
2.5 After 60 min admissible pressure drop < 0.6 bar	<input type="text"/>	3.4 Remarks admissible pressure drop < 0.2 bar	<input type="text"/>



To ensure that the underground network is completely watertight, we advise you to heat the system at 85°C for one hour, regularly checking that the connections are secure. Let the system cool down to 20°C before conducting a final check of all pipe connections.

See our technical manual for more details.

PROJECT ASSISTANCE

We would be delighted to help you draw up a quote.
 Fill out the list and return by email to microflexsales@wattswater.com
 or by fax to **+32 16 44 03 68**



For more information,
 call us on **+32 16 44 21 37**

State application

APPLICATIONS	HEATING	<input type="checkbox"/>
	SANITARY	<input type="checkbox"/>
	COOLING	<input type="checkbox"/>
	COLD POTABLE	<input type="checkbox"/>
Number take off points (<i>fill out below</i>):		
Length/power cons. 1 m / kW	
Length/power cons. 2 m / kW	
Length/power cons. 3 m / kW	
Length/power cons. 4 m / kW	
Length/power cons. 5 m / kW	

Flow temperature	°C
Return temperature	°C
Flow pressure	bar
Volumetric flow	m ³ /h or l/s
Heating capacity	kW
Total length piping network	m
Wall feed-through?	YES / NO *	
For pressurised water?	YES / NO *	
Self-regulating heating cable?	YES / NO *	
Installation plan? Non-scalable diagram? <i>If yes, please add.</i>	
Tender specifications? <i>If yes, please add.</i>	YES / NO *	

If you require more space to enter your customer's detail, please add list.

** delete as appropriate.*

Company name

Contact person

Function

Direct tel

Fax

E-Mail

Address

.....

.....

- Would you like us to contact you?
- Would you like one of our representatives to visit you?
- Would you like to receive our technical manual?
- Would you like to receive documentation on our products?

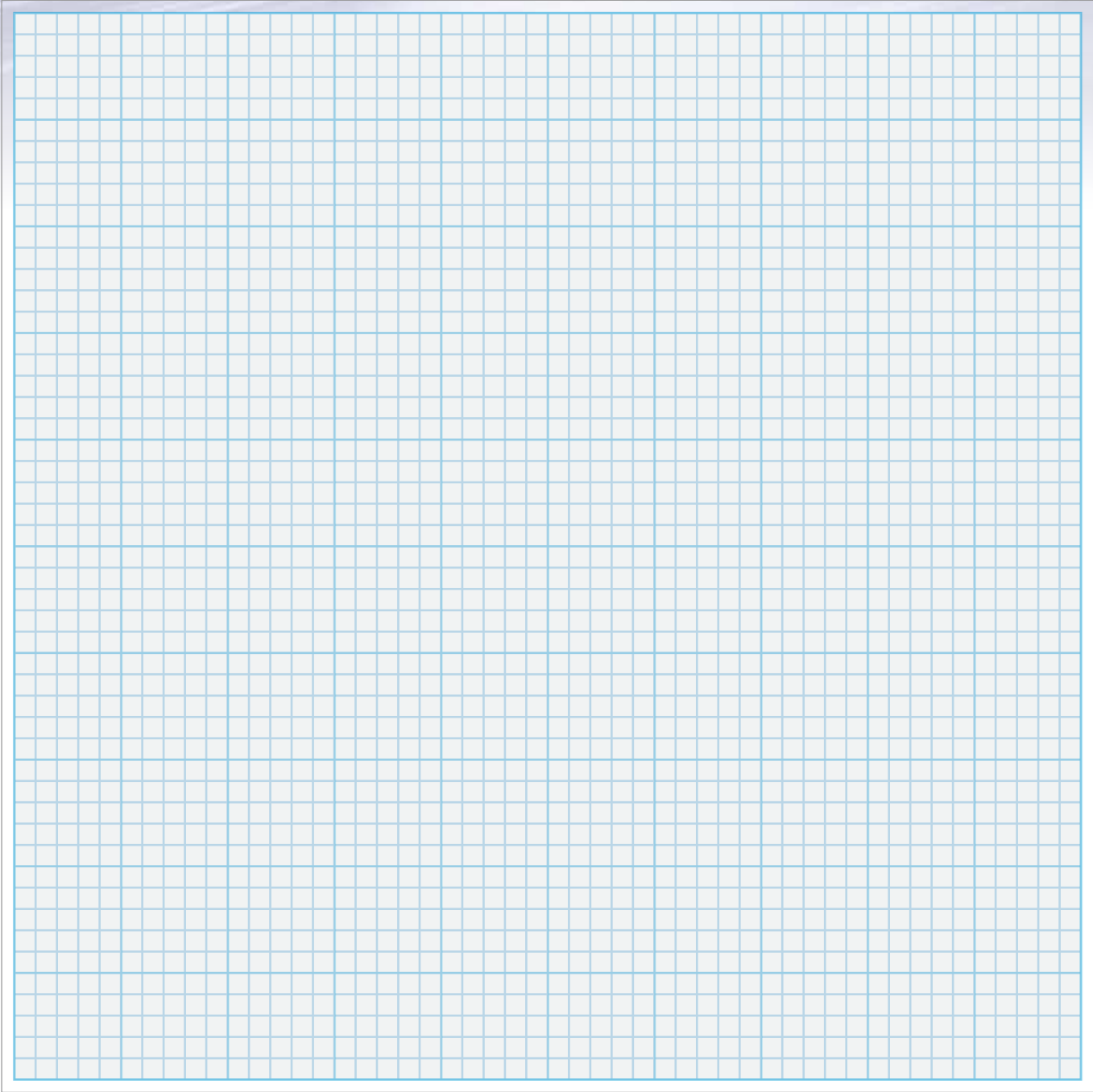

Watts Insulation NV

Belgium - commercial office:

General Customer Service -
Logistics - Administration
t +32 (0)16 44 21 31 - f +32 (0)16 44 03 68
microflexsales@wattswater.com
www.wattsinsulation.com
www.microflex.be

Italy:

Customer service - Logistics - Production
t +39 0461 96 51 11 - f +39 0461 96 55 50

UK:

Customer Service - Logistics
t +44 1480 40 70 74 - f + 44 1480 40 70 76

Production site:

Watts Industries Italia S.r.l.
Via Vienna 3
I-38121 Gardolo
Italia

GENERAL TERMS AND CONDITIONS

I Sales terms and conditions

1. **Scope:** Unless explicitly stated otherwise in writing, the contractual relationship between the vendor and purchaser will be governed exclusively by the present general terms and conditions as well as the specific terms and conditions (hereinafter jointly referred to as the "Agreement"). In case of contradiction between the specific terms and conditions on the one hand, and the present general terms and conditions on the other hand, the contents of the specific terms and conditions will prevail.
Any other terms and/or conditions from the purchaser will be considered null and void unless explicitly otherwise approved of in writing by the vendor. In such case the present general terms and conditions will nevertheless apply, provided these are not in contradiction with the approved upon terms and conditions of the purchaser. The present general terms and conditions are communicated to the purchaser prior to the conclusion of the Agreement. By accepting an offer from the vendor, the purchaser acknowledges that he has understood the present general terms and conditions and that he agrees with them without reserve.
The present general terms and conditions can in no event be tacitly deviated from. Merely tolerating the purchaser's conduct contrary to the Agreement, does in no event imply a renouncement by the vendor of the contents of the present general terms and conditions.
2. **Offers:** The offers will remain valid for a thirty day period following the sending of the offers. The offers constitute an indivisible whole. They are a mere proposal from the vendor and they do not bind the vendor. All information, drawings and other data provided by the purchaser to the vendor are deemed to be accurate and complete, on the basis of which the vendor has made his offer to the purchaser. The purchaser is at all times responsible for the choice of the sold goods. The sold goods are standard goods, which are not specifically produced for the purposes of the purchaser. The vendor cannot be held liable if it should appear that the sold goods cannot be used for the use or purpose envisaged by the purchaser.
3. **Order confirmation:** An order by the purchaser will bind the purchaser, but will only bind the vendor upon his written acceptance thereof.
4. **Intermediaries (sales representatives or agents):** Any order which is placed by an agent, a dealer or a representative, and the undertakings made by them, will only bind the vendor upon his written acceptance thereof.
5. **Delivery conditions:** Delivery shall be ex works premises vendor (Incoterms 2000). However, parties are entitled to designate by mutual agreement a different delivery address. In such case the sold goods will be transported at purchaser's risk and expense, even if the vendor takes care of the transport.
6. **Transfer of ownership and title:** Ownership and title to the sold goods is transferred only when payment in full has been received for the agreed upon purchase price (and costs, if any). The purchaser undertakes to store the sold goods in kind and not to make them immovable by destination, nor to mix the sold goods with any other moveable goods until full payment of the purchase price (and the costs, if any) has been made. As long as the vendor has not received payment in full for the agreed upon purchase price (and costs, if any), the purchaser will not pledge the sold goods nor create any interest, lien or encumbrance in the sold goods.
As long as the transfer of ownership and title has not been completely carried out, the purchaser will use all possible endeavours to protect the sold goods against any form of partial or complete loss and shall equally provide for appropriate insurance coverage.
7. **Times for delivery:** The times for delivery are merely given as estimates. Therefore in the event of non performance of the given delivery date, the purchaser is not entitled to claim compensation or to refuse to accept the sold goods. In the event the purchaser has not collected the sold goods at the agreed upon time and date, the vendor may, 15 days following said agreed upon time and date, without any notice of default required, consider the Agreement as cancelled by law. In such case the vendor will furthermore be entitled to claim compensation for the damages incurred by the fact that the sold good were not collected or that the sold goods were not collected in a timely manner.
8. **Force majeure:** In the event of force majeure (including, but not limited to accidents, acts of war, strikes, lock outs, rebellions, lack of transport, fire at the vendor's premises, modified economic conditions, ...) the vendor will be entitled, without any compensation due, to postpone the delivery of the sold goods for the duration of such force majeure.
9. **Conditions of performance:** The vendor is entitled to make those alterations to the ordered goods as deemed required, whether or not due to changes in the production or assembly process, ...
10. **Acceptance - defects:**
 - a. The purchaser is obliged to notify (by registered mail) the vendor of the non conformity of the goods and any visible defects within 48 hours as from the date of delivery of the goods in accordance with the provisions of the present general terms and conditions, in default of which the purchaser is deemed having accepted the sold goods and the vendor can no longer be held liable for non-conformity of the delivered goods and any visible defects. Any nonconformities and visible defects must always be stated on the waybill (CMR).
 - b. The purchaser furthermore warrants that the sold goods are free of any hidden defects, however limited to a period of 6 months as from the date of delivery of the goods in accordance with the provisions of the present general terms and conditions. The purchaser shall however have no remedy for hidden defects if the purchaser fails to notify (by registered mail) the vendor of such hidden defect within 7 days following the discovery by the purchaser of any hidden defect or following the moment on which the purchaser should have discovered the hidden defect.
The vendor cannot be held liable for the quality or the capacity of the sold goods in case the defect in quality or capacity results from a specific, abnormal or wrongful use.
The vendor can only be held liable for hidden defects if the defect is contradictorily established. In case of an established hidden defect, the vendor will, at his option, either repair or replace the defect part of the sold goods or reimburse that part of the paid price corresponding to the defect part of the sold goods. The purchaser will not be entitled to any other compensation.
In the event identical goods are no longer available due to a change in production, the vendor will be entitled to replace the defect part of the sold goods by a similar part.
 - c. After the above mentioned 6 months period, the vendor can no longer be held liable for any defects in the sold goods, apart from claims solely based upon, and in accordance with the terms and conditions of, the guarantee provided by the vendor, as set forth under section II Guarantee.

d. Except for the explicit obligations entered into by the vendor pursuant to the present general terms and conditions, the liability of the vendor is limited to the liabilities mandatorily imposed by law. The vendor can in no event be held liable for any indirect or consequential damages, such as, but not limited to, loss in sales, increase in general costs, damage to third parties or goods belonging to third parties.

11. **Price and payment:** The price mentioned in the order confirmation is quoted exclusive of VAT, taxes and duties and includes neither the costs of delivery or collection of the sold goods nor any mounting or installation costs. These charges, duties and costs are entirely at purchaser's expense.
All invoices are payable 30 days following the date of the invoice by transferring the invoiced amount to one of the bank accounts figuring in the invoice, stating the invoice number. The invoices are payable at vendor's registered offices.
Any protest against the invoice will be made by registered letter within 5 business days following the receipt of the invoice.
In case of non-payment or partial payment of the invoice within the given period of time, a 1 % per month default interest, as from the due date of the invoice, will be due by right, even in the absence of notice of default. Should the case occur, said interest will be charged pro rata temporis. Moreover, in case of non-payment or partial payment of the invoice within the given period of time, a 10 % lump sum compensation of the invoiced amount will be charged, with a minimum of 200 EUR, without prejudice to the right of the vendor to prove larger damages and to claim a higher compensation. The costs resulting from any recovery of the invoices before the court, will also be charged to the purchaser.
The non-payment or partial payment of any invoice by the purchaser will automatically bring about that any other outstanding amount will immediately become due by right. In such case the vendor will, without any indemnification due by the vendor, equally be entitled to suspend any new or existing Agreement or terminate such new or existing Agreement with immediate effect by notification (by registered mail) to the purchaser. In addition to the above, the vendor will be entitled to a 30 % lump sum compensation of the invoiced amount, without prejudice to the right of the vendor to prove larger damages and to claim a higher compensation.
12. **Jurisdiction:** Any and all disputes shall be brought exclusively before the courts of Leuven (Belgium).
13. **Applicable law:** The Agreement will be governed by Belgian law, however excluding its conflict of law provisions.

These general terms and conditions have been translated from the original Dutch version. In the event of conflict, the Dutch version will prevail.

II Guarantee

1. **Scope:**
 - a. The vendor provides the purchaser, and, in the event of a resale by such purchaser, the end-user (hereinafter jointly referred to as the "Purchaser") with a ten year guarantee on the goods sold by the vendor. Said guarantee period commences on the date of delivery of the sold goods, i.e. the date of the delivery ex works premises vendor (Incoterms 2000).
 - b. The present guarantee will cover defects in the materials used by vendor, defects in the production or assembly of the sold goods or structural faults. However the Purchaser will be required to prove that such defect or fault does not result directly or indirectly from:
 - a faulty installation, for the purpose of this provision will be considered (without being restricted thereto) as a "faulty installation" any and all (i) installation performed by a not accredited and not registered contractor, (ii) installation performed contrary to the installation instructions and guidelines of the technical manual of the vendor, (iii) installation performed contrary to good craftsmanship ("state of the art"), and (iv) installation for which the vendor has not received, within 7 days as from the date of first use, but in any case within 1 year as from the date of delivery of the sold goods by vendor, the fully completed and signed density test form, provided by the vendor (included in the delivery of the sold goods and part of the technical manual of vendor).
 - abnormal or incorrect use of the goods, for the purpose of this provision will be considered (without however being restricted thereto) as an "incorrect use" any and all use of the goods contrary to the instructions and guidelines specified in the technical manual of the vendor.
 - lack of appropriate maintenance and (annual) review.
 - use of incompatible spare parts or accessories.
 - subsequent alterations by the Purchaser.
 - external elements.
 - c. Moreover, the present guarantee will not apply to defect goods for which the corresponding invoice of the vendor has not been paid in full in accordance with the applicable payment terms.
2. **Notification:** In order to invoke the present guarantee, the Purchaser is required to notify (by registered mail) the vendor of its claim within the above mentioned guarantee period and within 7 days following the discovery by the Purchaser of any defect or following the moment on which the Purchaser should have discovered the defect. The defect furthermore needs to be contradictorily established, failing which the Purchaser will no longer be entitled to invoke the present guarantee.
3. **Fulfillment of guarantee obligation:** In the event the Purchaser has invoked the present guarantee rightfully, the vendor will, at his option, either repair or replace the defect part of the sold goods or reimburse that part of the paid price corresponding to the defect part of the sold goods. The purchaser will not be entitled to any other compensation (such as, but not limited to, compensation for indirect or consequential damages).
In the event identical goods are no longer available due to a change in production, the vendor will be entitled to replace the defect part of the sold goods by a similar part.
The fulfillment of the guarantee obligation by the vendor will not result in an extension of the overall guarantee period.
4. **Miscellaneous:** The present guarantee is without prejudice to any and all rights and obligations mandatorily imposed or provided for by law.
The transfer of rights under the present guarantee by the Purchaser vis-à-vis the vendor will at all times require the written approval by the vendor.

MICROFLEX®

Flexibility, all the way.

Supplies?
Always in stock



Delivery?
Always on time on-site



Installation?
Always more flexible,
at a lower cost



Watts Insulation NV

Belgium - Commercial office:

General Customer Service -
Logistics - Administration
t +32 (0)16 44 21 31 - f +32 (0)16 44 03 68
microflexsales@wattswater.com
www.wattsinsulation.com
www.microflex.be

Italy:

Customer service - Logistics - Production
t +39 0461 96 51 11 - f +39 0461 96 55 50

UK:

Customer Service - Logistics
t +44 1480 40 70 74 - f + 44 1480 40 70 76

WATTS
INSULATION

A Company of Watts Water Technologies EMEA B.V.