

## The Bible to the Building Industry

We are proud to introduce to you the latest edition of our Catalogue which has become known as the Bible to the Building Industry.

Consisting of over 600 full colour pages it has products to fulfil the requirements of both the Contractor and Specifier.

Divided into easy to read sections with details and technical data of over 40.000 items, and with each section headed by our own manufactured ranges of Olympus, Nicobond and Phlexicare, we have produced an indispensable reference and ordering guide for your business.

This catalogue presents a comprehensive overview of both our stock ranges and material available to order, which can be despatched by our delivery service, or if you wish to collect you can take advantage of our Express Collect service.

Our unique product numbering system and colour coded sections allows for easy reference making product selection faster. In addition, the catalogue is now available on CD Rom and there is a separate price guide which is subject to trade discounts.

We are very proud of our long history and our continuing status as an independent builders merchant. Over the years we have continued to develop and supply the changing needs of our customers. Employing experienced and committed staff and with a nationwide distribution network, we are in the position of being able to respond quickly to changing demands whilst maintaining highly valued personal contact with our customers.

N & C Building Products Ltd



**Tel: 020 7247 5432**

## Contents and User Guide

The colour coded tabs in the corner of each page in the catalogue will enable the user to easily identify the section within our Product Range, which is of particular interest when placing an order or specifying products. Details of each section and its colour code together with the general contents of that section are listed below.

Introduction 3

### OLYMPUS SANITARYWARE

Acrylic Baths	5 - 9
Luxury Acrylic Baths	10 - 16
Modern Range	17 - 22
Wall Hung Range	23 - 26
Designer Range	27 - 30
Broadgate Range	31 - 34
Commercial Range	35 - 42
Phlexicare Range	43 - 52
Brassware Ranges	53 - 66

### PHLEXICARE PRODUCTS

Bathing	67 - 74
Showering	75 - 99
Pressalit	100 - 105
Accessories and Toilet Seats	106 - 109
Grab Rails	110 - 115
Kitchens and Appliances	116 - 130
Lifting and Handling	131 - 132
Ironmongery	389 - 394

### GENERAL SANITARYWARE

Steel and Cast Iron Baths	133 - 137
Olympus BSS Ware	138 - 139
Contract Commercial Products	140 - 154
Bathroom Suites	155 - 164
Olympus Bathroom Furniture	165 - 167
Olympus Glass Bowls	168 - 169
Olympus Washroom Systems	170 - 178
Brassware	179 - 182
Commercial Brassware	183 - 187
Saniflo	188 - 189
Urinals and Fireclay Sinks	190 - 194
Showering	195 - 213
Bathroom and Washroom Accessories	214 - 226
Plumbing	227 - 237
Heated Towel Warmers	238 - 239
Heaters and Tanks	240 - 242
Stainless Steel Products	243 - 253

### OLYMPUS KITCHENS

Furniture - Bronze Specification	254 - 257
Furniture - Silver Specification	258 - 263
Furniture - Gold Specification	264 - 267
Worktops	268 - 269
Sink Tops	270 - 273
Appliances	274 - 277
Spacesavers and Accessories	278 - 281

### CASTINGS

Manhole Covers and Frames	282 - 288
Gratings and Frames	289 - 291
Sash Weights	292
Cast Iron Rainwater, Soil and Drain	293 - 308
Plastic Soil, Waste, Overflow and Rainwater Systems	309 - 313

### GLASS AND GLAZING PRODUCTS

Processed Glass	314
Stock Glass	314
Sealed Units	314

### OLYMPUS IRONMONGERY

Homestyle Range	315 - 359
Designer Range	360 - 369
Architectural Range	370 - 388

### GENERAL IRONMONGERY

Door Furniture	395 - 414
Locks and Latches	415 - 431
Security Fittings	432 - 447
Hinges & Gates and Garage Doors	448 - 456
Door Controls	457 - 463
Bolts	464 - 467
Fire Door Hardware	468 - 471
Signage	472 - 477
Fire Safety Equipment	478 - 479
Window Fittings	480 - 491
Sliding Door Fittings	492 - 498
Draught Excluders	499 - 501
Shelving	502 - 508
Fixings	509 - 516
Miscellaneous	517 - 521
Tools and Power Tools	522 - 525 & 538
Ladders	526 - 527
Builders Hardware	528 - 537

### DECORATING PRODUCTS

Paints and Primers	539 - 548 & 553
Wood Treatments and Varnishes	549 - 552 & 554 - 557
Waterproofing Products	558 - 560
Repair Compounds	561 - 562
Brushes, Rollers and Tools	563 - 565
Decorating Sundries	566 - 569 & 571 - 572 & 574 - 575
Fillers and Adhesives	570
Chemicals	573
Sealants and Putty	576 - 578
Louvres	579 - 580

### NICOBOND PRODUCTS

Ceramics	581 - 583
Adhesives, Grouts and Screeds	584 - 594
Tools and Accessories	595 - 596
Tile Trims and Seals	597 - 598
Tiling Accessories	599
Wood Flooring	600
Group Locations	602 - 603
Index	604 - 607
Terms and Conditions	608

All stocked products within The Catalogue have an easy order computer product code to enable our sales team to provide immediate stock and price information when requested.

There is also a full and comprehensive index of products detailed on the final pages of our publication.





**N&C**  
*Olympus*

# Sanitaryware

The N & C Group of Companies are proud to present the OLYMPUS Range of quality sanitaryware. Whilst being designed with beauty and style in mind, this range meets the needs of home owners and specifiers alike.

Whether trying to create a luxurious bathroom for your home, a hotel bathroom with elegance and style, an accessible toilet facility for the elderly or disabled, indeed a commercial washroom to stand the vigours of day to day use, OLYMPUS encapsulates all of these requirements.

**OLYMPUS ACRYLIC BATHS**

- Made from ICI Reinforced 5mm Acrylic
- Fully Incapsulated Base Board
- Superior Legset with Adjustable Feet - Reinforced Galvanised Frame
- Easy Fix Wall Plate to Aid Installation
- **Stocked Baths** - Lindos, Crete, Broadgate. All Two Tapholes
- **All Other Baths To Order.** State Taphole Requirements when ordering.
- Phlexicare Shower Tub - Stocked with no Tapholes
- Whirlpool and Spa Systems Available on all **Luxury** Baths

Acrylic Baths

**Lindos (Twingrip)**

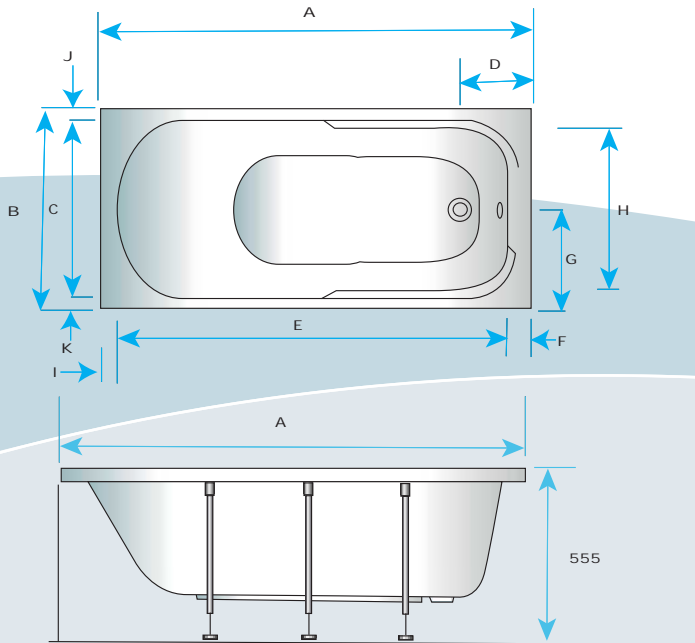

**Sizes Available:**

- S7006100 - 150 x 70cm**
- S7006101 - 160 x 70cm**
- S7006102 - 170 x 70cm**
- S7006103 - 170 x 75cm**
- S7006115 - Chrome Handgrips**

Size mm	A	B	C	D	E	F	G	H	I	J	K
170x70cm	1700	700	620	250	1550	85	350	560	50	40	40
160x70cm	1600	700	620	250	1450	85	350	560	50	40	40
150x70cm	1500	700	620	250	1350	85	350	560	50	40	40
170x75cm	1700	750	670	250	1550	85	375	610	50	40	40

## Broadgate

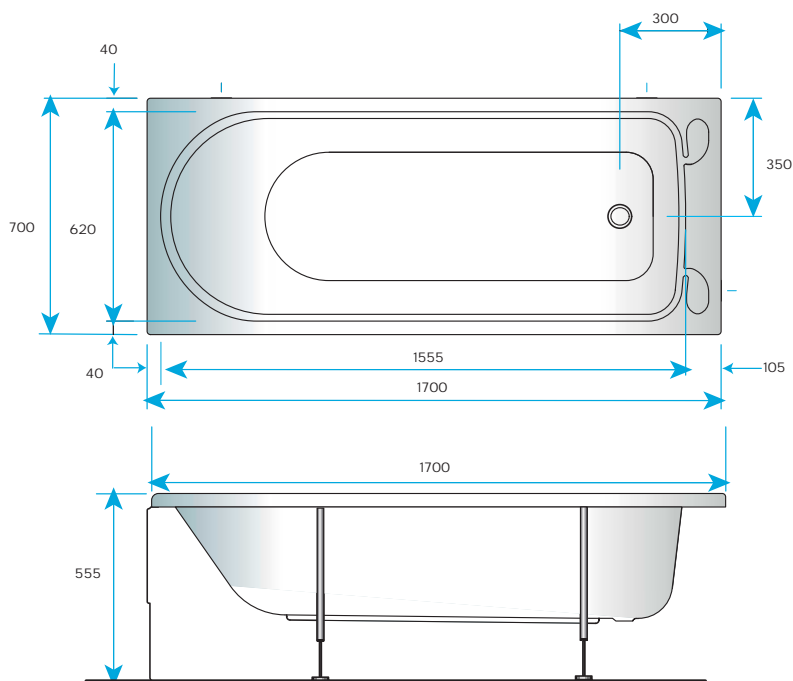

S7006107 - 170 x 70cm



## Crete

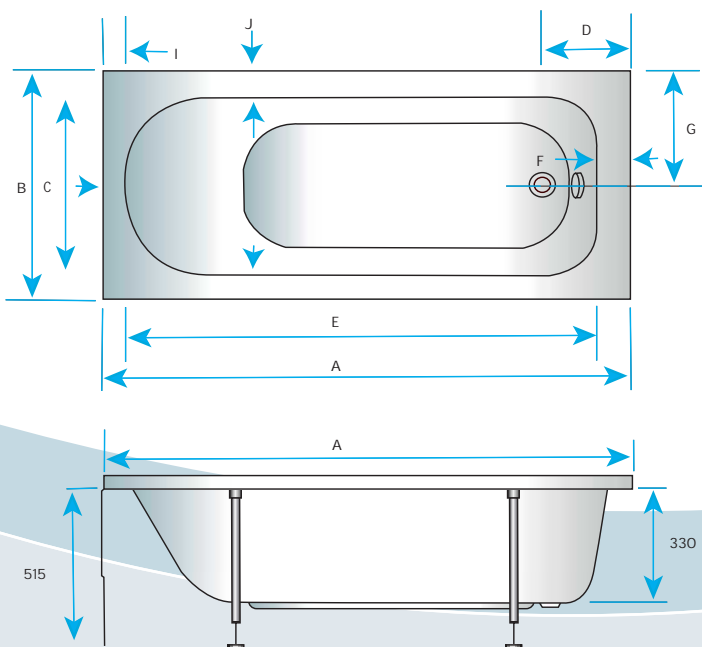

**Sizes Available:**

S7006104 - 150 x 70cm

S7006105 - 160 x 70cm

S7006106 - 170 x 70cm

Size mm	A	B	C	D	E	F	G	H	I	J	K
170x70cm	1700	700	530	250	1555	90	350	515	55	85	85
160x70cm	1600	700	530	250	1455	90	350	515	55	85	85
150x70cm	1500	700	530	250	1355	90	350	515	55	85	85

For Taps and Mixers See Olympus Brassware Ranges Page 53

Olympus

**Bath Shower Tub**

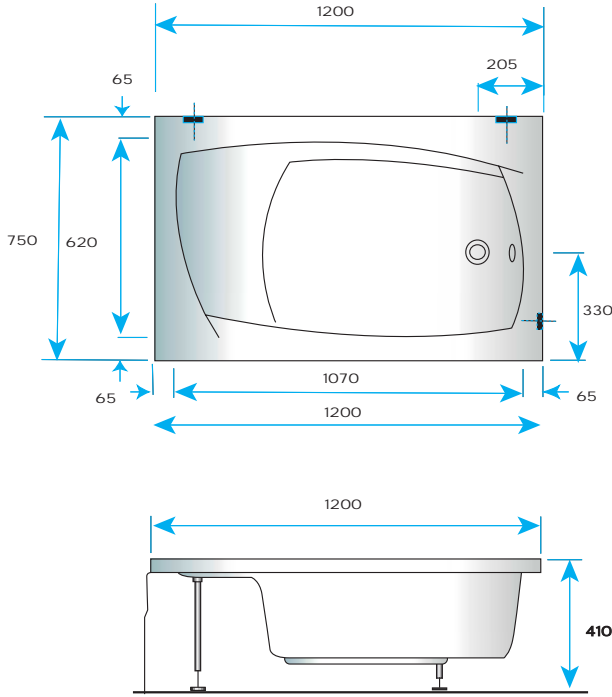

P6808585 - 120 x 75cm

**Hellina**

Acrylic Baths

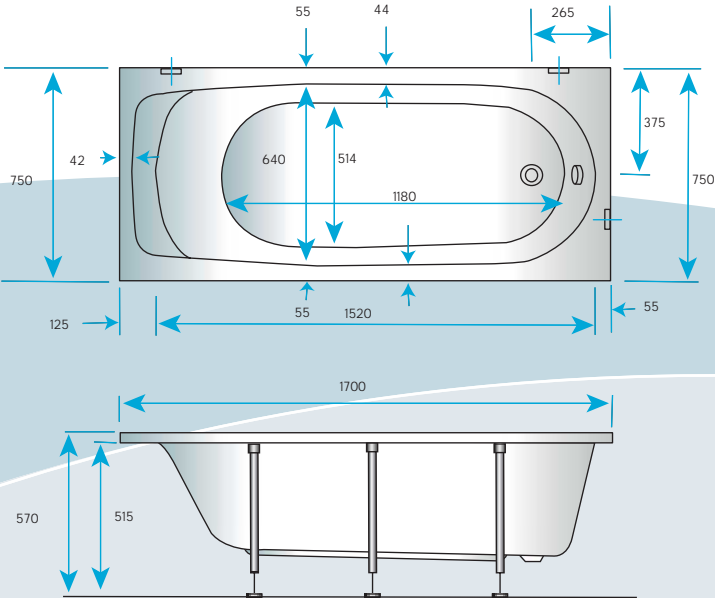

S7006135 - 170 x 75cm

**Zante**

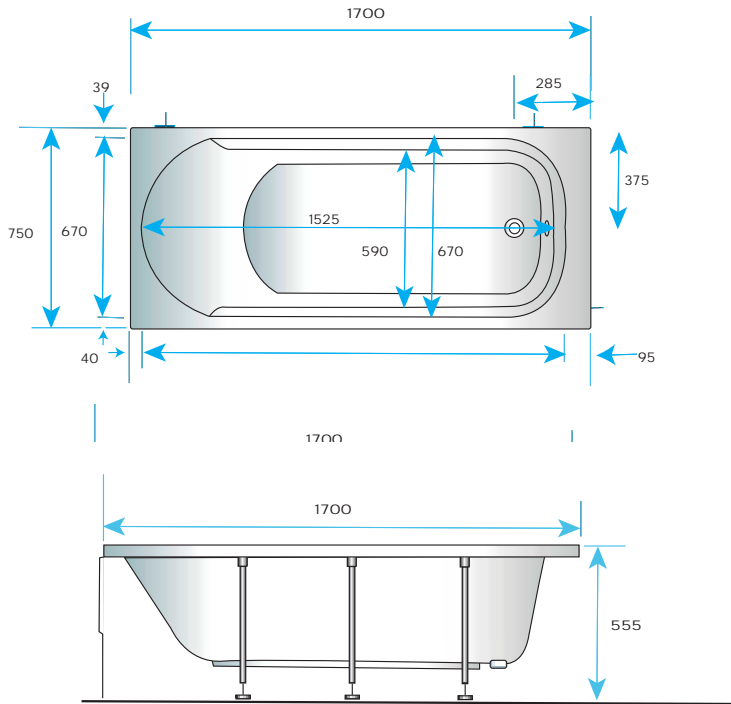

**S7006121 - 170 x 75cm**

**Rodos**

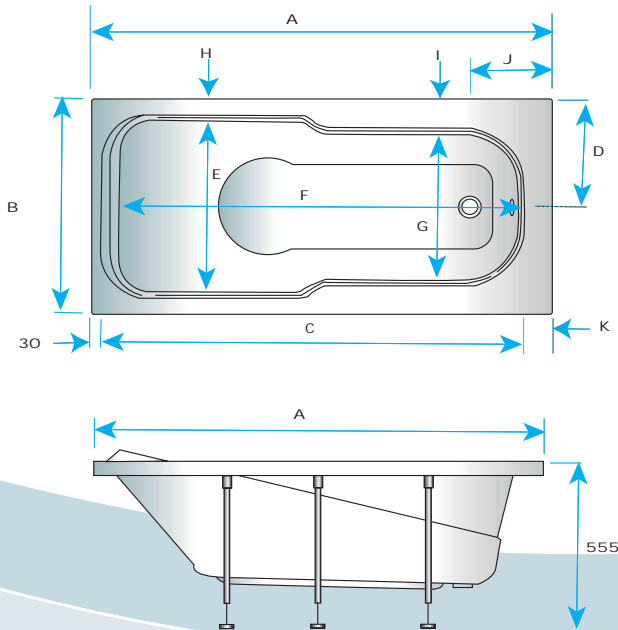

- Sizes Available:**  
**S7006123 - 150 x 70cm**  
**S7006124 - 160 x 70cm**  
**S7006125 - 170 x 70cm**  
**S7006126 - 170 x 75cm**

Size mm	A	B	C	D	E	F	G	H	I	J	K
170x70cm	1700	700	1580	350	580	1510	510	50	90	270	90
160x70cm	1600	700	1480	350	580	1410	510	50	90	270	90
150x70cm	1500	700	1380	350	580	1310	510	50	90	270	90
170x75cm	1700	750	1580	375	630	1510	560	50	90	270	90

For Taps and Mixers See Olympus Brassware Ranges Page 53

**Olympus**

**Offset Right / Offset Left**

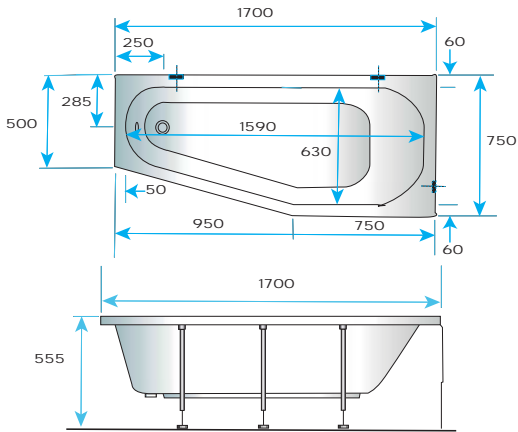

**1.OFFSET RIGHT**  
**S7006128 -170 x 75 x 50cm**

**2.OFFSET LEFT**  
**S7006127 -170 x 75 x 50cm**

**Troodos**

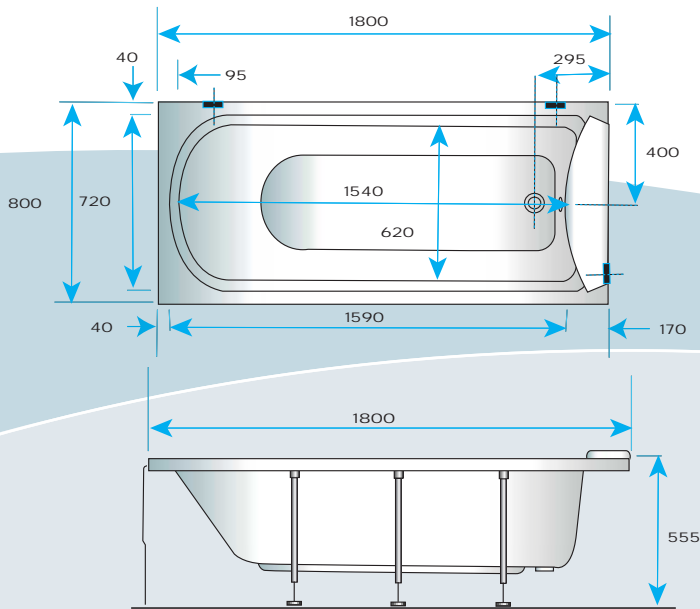

**S7006116 - 180 x 80cm**

**Acrylic Luxury Baths**





Olympus

**Elanos**

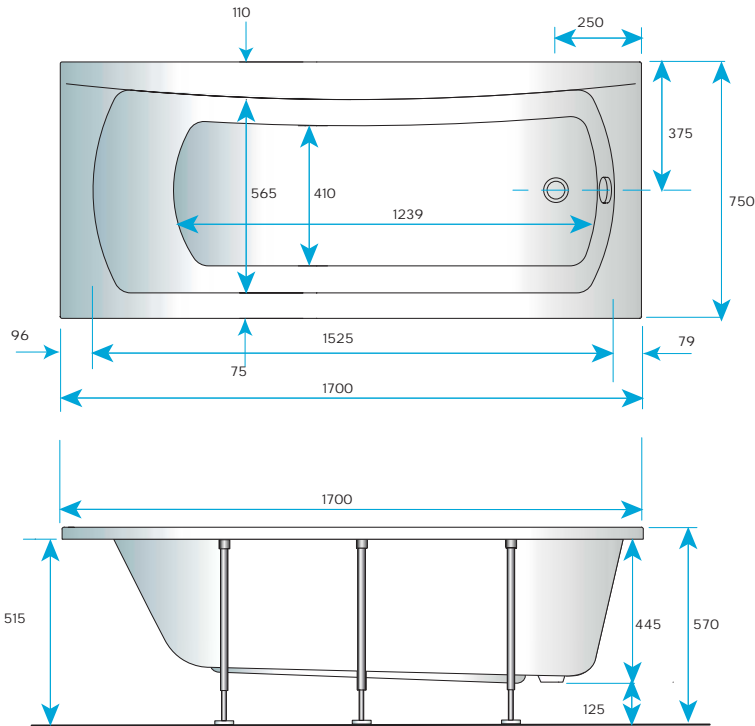

S7006136 - 170 x 75cm

**Nicos**

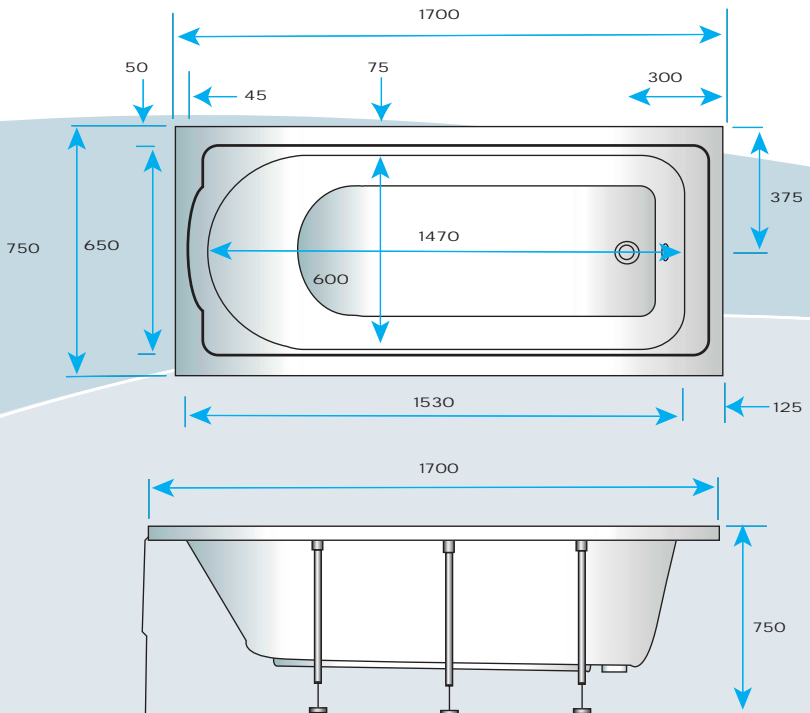

S7006122 - 170 x 75cm

Acrylic Luxury Baths



**Paphos**

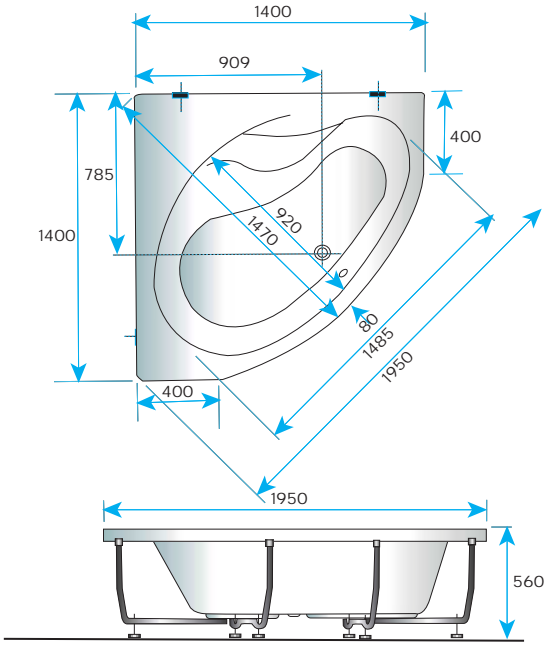

**S7006132 - 140 x 140cm (Complete with Curved Panel)**

**Corfu**

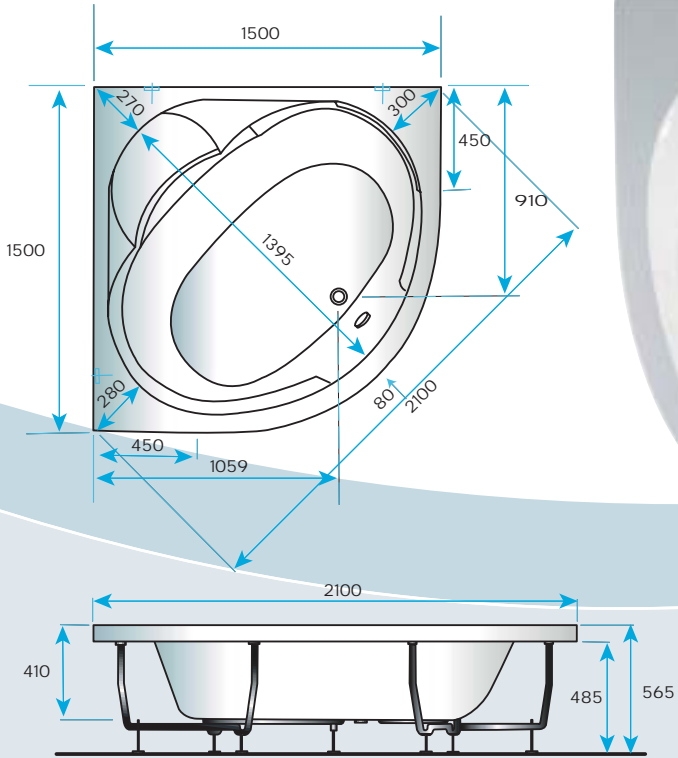

**S7006131 - 150 x 150cm (Complete with Curved Panel)**

For Taps and Mixers See Olympus Brassware Ranges Page 53

Olympus

**Ixia Right**

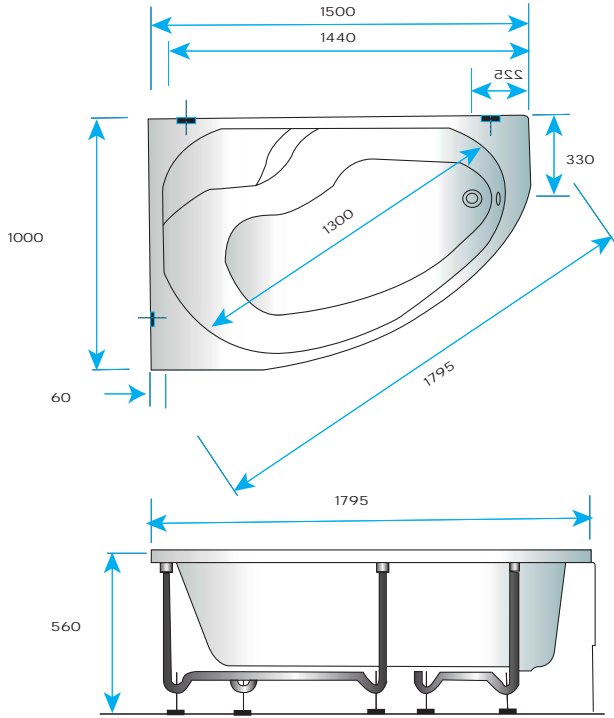

**S7006130 - 150 x 100 cm (Complete with Curved Panel)**

**Ixia Left**

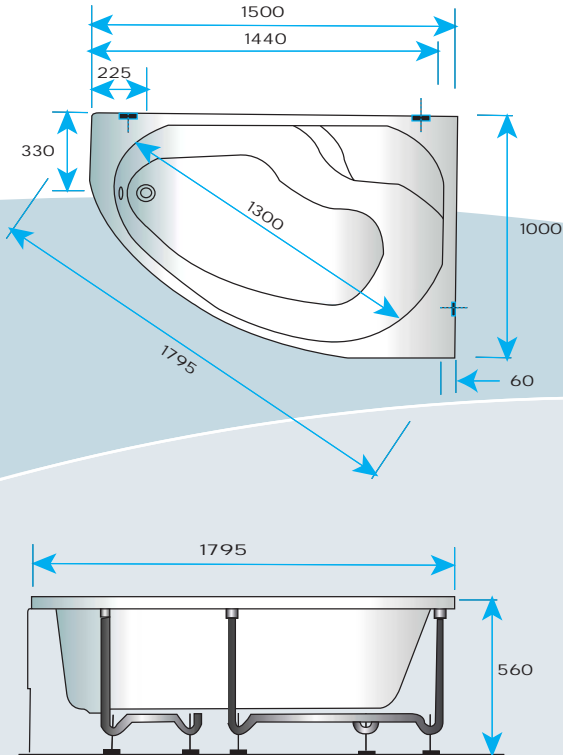

**S7006129 - 150 x 100cm (Complete with Curved Panel)**

Acrylic Luxury Baths

**Ageana**

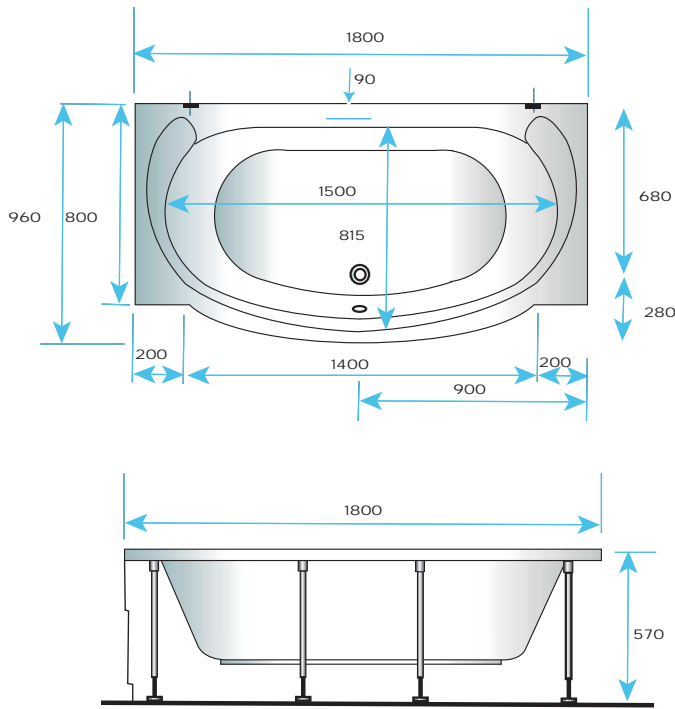

**S7006119 - 180 x 96 x 80cm (Complete with Curved Panel)**

**Ageana Plus**

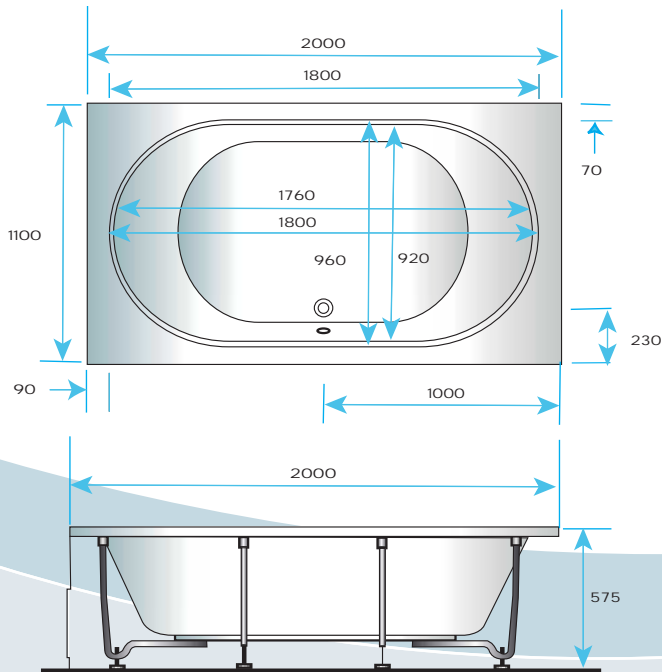

**S7006120 - 200 x 110mm (Complete with Front Panel)**

**Olympus**

Acrylic  
 Luxury  
 Baths

For Taps and Mixers See Olympus Brassware Ranges Page 53

## Athens Bath Panels

- S7006110 - Athens 170cm Acrylic Front Panel (Reinforced)
- S7006111 - Athens 160cm Acrylic Front Panel (Reinforced)
- S7006112 - Athens 150cm Acrylic Front Panel (Reinforced)
- S7006113 - Athens 70cm Acrylic End Panel (Reinforced)
- S7006114 - Athens 75cm Acrylic End Panel (Reinforced)



## Broadgate Bath Panels

- S2000161 - Broadgate Front Panel 1700mm White
- S2000171 - Broadgate End Panel 700mm White supplied with angle strip



For Wood Bath Panels See Page 137

# N&C *Olympus*



# Olympus

## Modern Range

**H.O C/C W.C. Suite Standard Height (Lever Flush)**

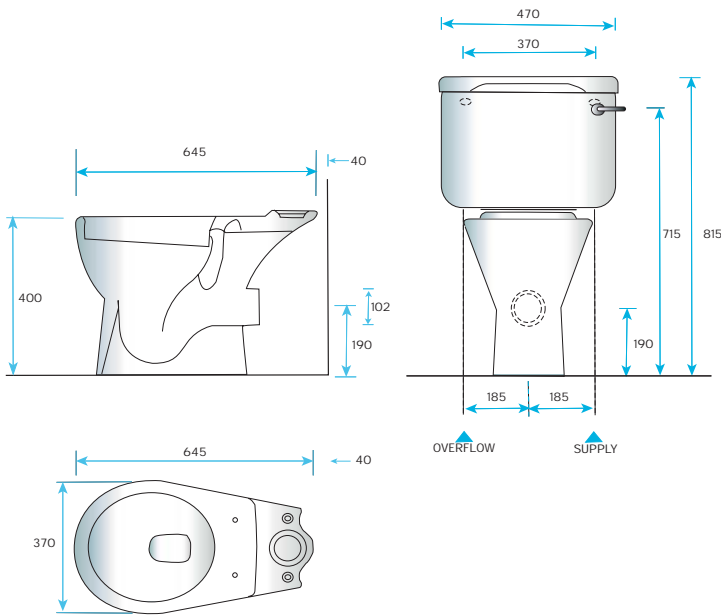

- S7004001 - OL1 H.O C/C W.C. Pan Standard Height**
- S7004032 - OL50 Seat and Cover (Top Fixing Stainless Steel Hinges)**
- S7004002 - OL3 C/C Cistern shell only (B.S & O)**
- S7004003 - Cistern Fittings Pack (Internal Overflow)**

**H.O C/C W.C. Suite Standard Height (Push Button Flush)**

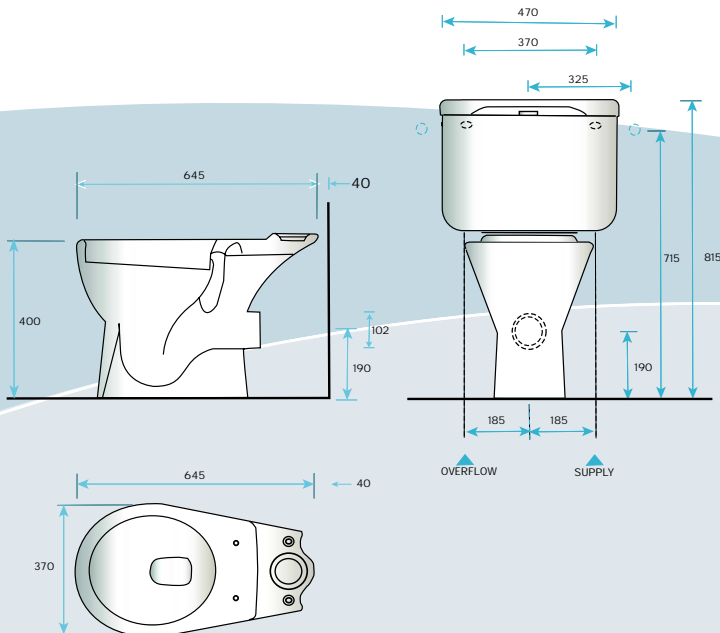

- S7004001 - OL1 H.O C/C W.C. Pan Standard Height**
- S7004032 - OL50 Seat and Cover (Top Fixing Stainless Steel Hinges)**
- S7004004 - OL32 C/C Cistern Complete with Push Button Fittings (SISO)**

Alternative Cistern:

- S7004046 - OL44 C/C Cistern Complete with Push Button Fittings (BIBO)**



**Back to Wall H.O W.C. Pan Standard Height**

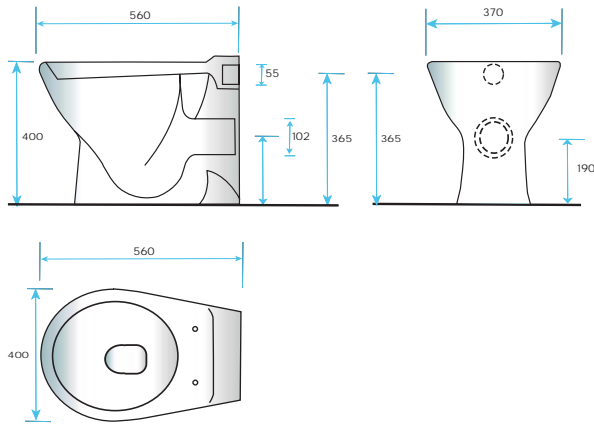

**S7004005 - OL4 Back to Wall H.O W.C. Pan Standard Height**  
**S7004032 - OL50 Seat and Cover**  
 (Top Fixing Stainless Steel Hinges)

(For Concealed Cistern Options see page 26)



**Floor Standing Bidet**

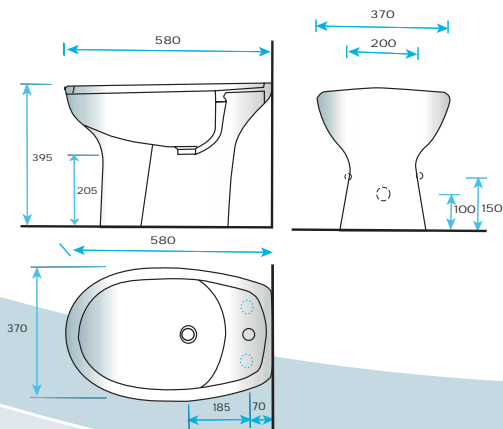

**S7004008 - OLB Floor Standing Bidet (Taphole 1)**



The Taps and Mixers Featured are Shown Within our Olympus Brassware Ranges See Page 53

**Olympus**

Modern Range

**Semi Countertop Basin**

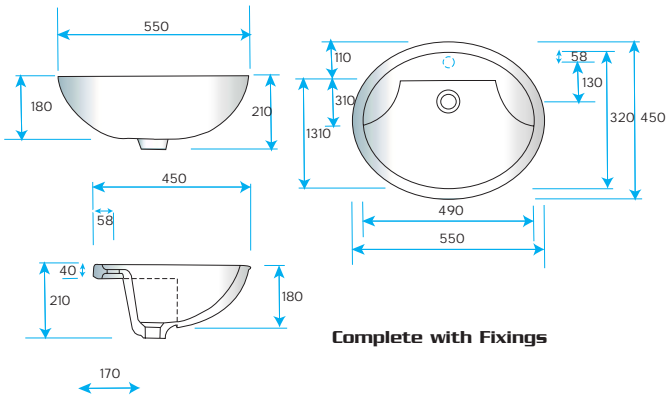

- S7004024 - OL24 Semi Countertop Basin (Taphole 1)
- S7004025 - OL36 Semi Countertop Basin (Taphole 2)

**Corner Basin with Semi Pedestal**

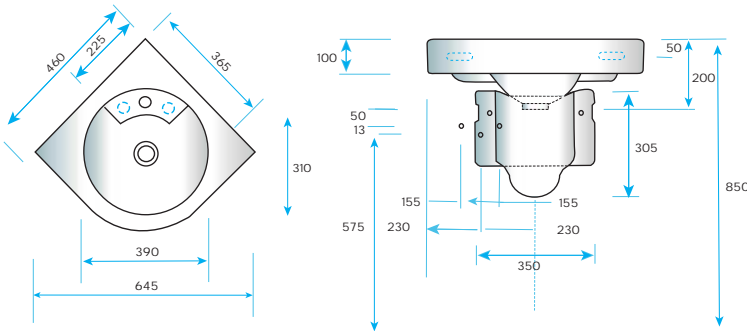

- S7004030 - OL41 46cm Corner Basin (Taphole 1) to Suit Semi Pedestal
- S7004031 - OL42 46cm Corner Basin (Taphole 2) to Suit Semi Pedestal
- S7004014 - OL17 Semi Pedestal (to suit OL41/OL42)
- S7004034 - Hanger Brackets (2pr Required for Each Basin)

**Full Inset Basin**

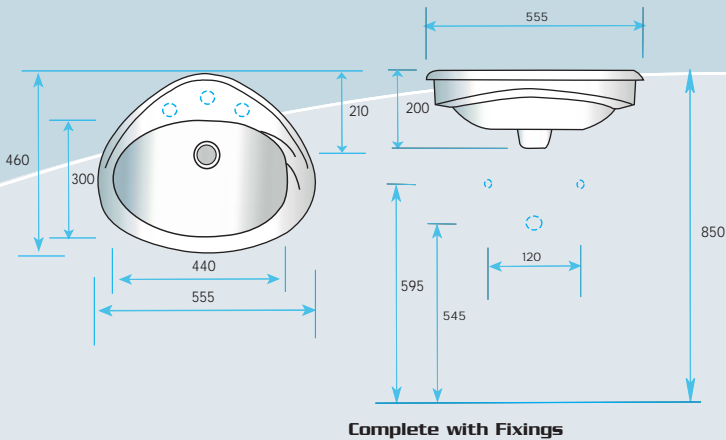

- S7004022 - OL21 Full Inset Basin (Taphole 1)
- S7004023 - OL35 Full Inset Basin (Taphole 2)

The Taps and Mixers Featured are Shown Within our Olympus Brassware Ranges See Page 53



## Semi Pedestal Basin or Wall Fixed

mm	a	b	c	d	e	f	g	h	i	j	k
550	550	450	185	180	45	620	570	280	700	470	295

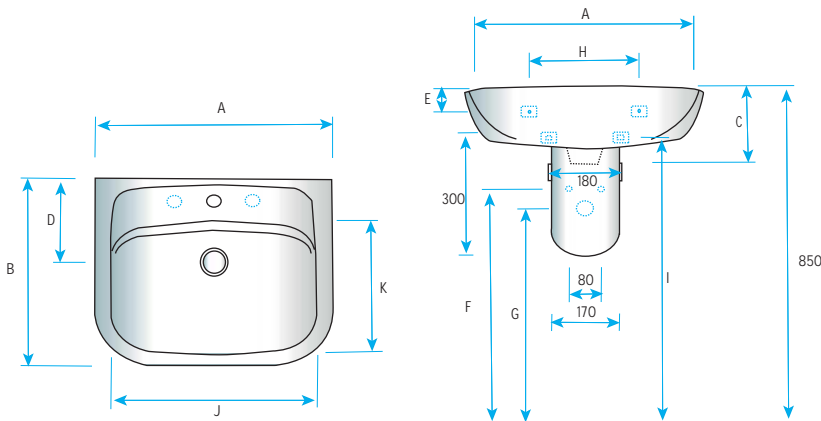

- P7004016 - OL27 55cm Basin (Taphole 1) Pedestal or Wall Fixed**
- P7004017 - OL33 55cm Basin (Taphole 2) Pedestal or Wall Fixed**
- P7004007 - OL13 Semi Pedestal (To suit OL27/OL33)**
- S7004036 - Combined Hanger and Waste Bracket**

## Pedestal Basin

mm	a	b	c	d	e	f	g	h	j	k
650	650	500	200	205	55	620	570	300	575	330
600	600	480	185	200	55	620	570	280	530	330
550	550	450	185	180	45	620	570	280	470	295

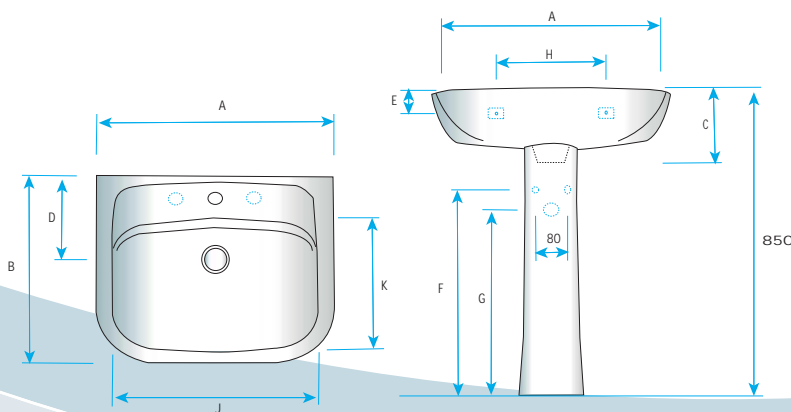

- P7004005 - OL11 60cm Basin (Taphole 1)**
- P7004006 - OL12 60cm Basin (Taphole 2)**
- S7004009 - OL9 65cm Basin (Taphole 1)**
- S7004010 - OL10 65cm Basin (Taphole 2)**
- P7004016 - OL27 55cm Basin (Taphole 1)**
- P7004017 - OL33 55cm Basin (Taphole 2)**
- S7004011 - OL14 Full Pedestal (To Suit all Above)**

The Taps and Mixers Featured are Shown Within our Olympus Brassware Ranges See Page 53

Modern Range

**Under Counter Basin**

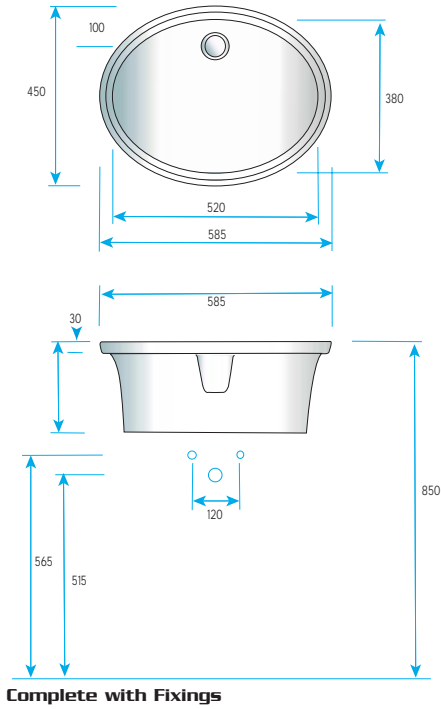

**S7004026 - OL25 Under Counter Basin**

**Basin Fixings and Brackets**

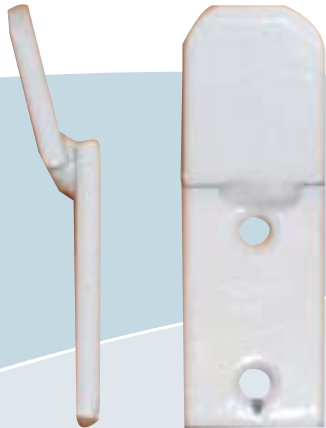

**S7004034**



**S7004036**

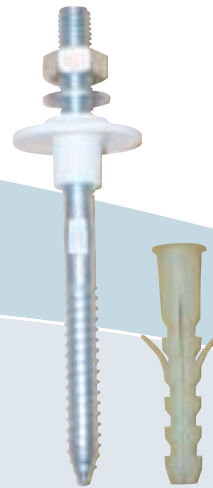

**S7004033**

**Fixing Brackets**

**S7004034 - Basin Hangers**

**S7004036 - Adjustable Hanger and Waste Bracket with Basin Fixings**

**S7004033 - Basin Fixing Bolt Set. (All Olympus Basins can be Bolted Directly to a Solid Wall with this set of Fixings)**



**N&C**  
*Olympus*

Olympus

Wall Hung Range

**Wall Hung H.O W.C. Pan**

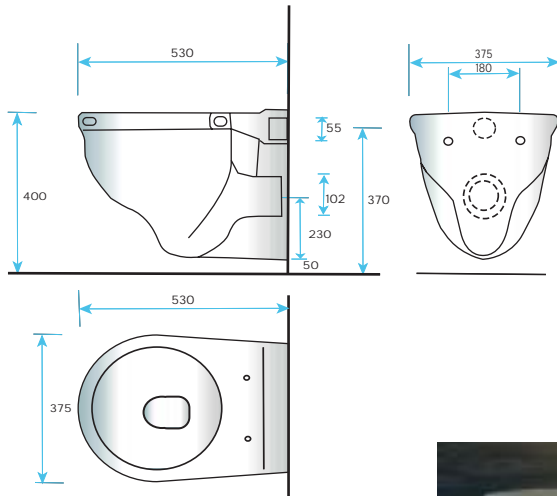

- S7004006 - OL6 Wall Hung WC Pan
- S7004032 - Seat and Cover
- S7004037 - Floor Support Brackets and Bolts

(For Concealed Cistern Options see page 26)

**Wall Hung Bidet**

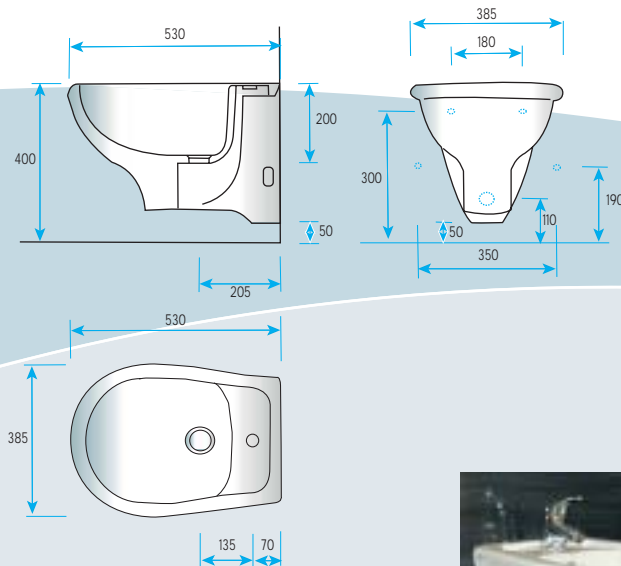

- S7004007 - OL7 Wall Hung Bidet (Taphole1)
- S7004037 - Floor Support Brackets and Bolts

The Taps and Mixers Featured are Shown Within our Olympus Brassware Ranges See Page 53



## Semi Pedestal Basin

mm	a	b	c	d	e	f	g	h	i	j	k
550	550	450	185	180	45	620	570	280	700	470	295

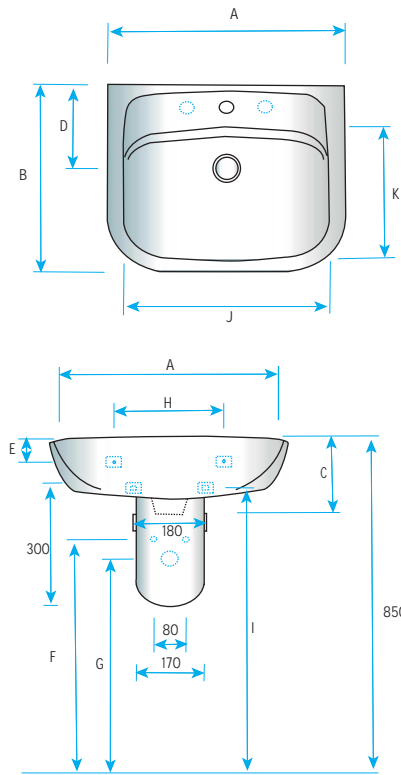

- P7004016 - OL27 55cm Basin (Taphole 1)
- P7004017 - OL33 55cm Basin (Taphole 2)
- P7004007 - OL13 Semi Pedestal (To suit OL27/OL33)
- S7004036 - Adjustable Hanger and Waste Bracket

Wall Hung Range

## Fixings and Brackets



S7004037



S7004036

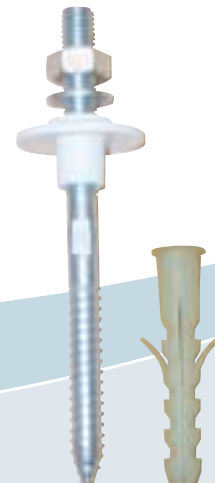

S7004033

### Fixing Brackets

- S7004036 - Adjustable Hanger and Waste Bracket with Basin Fixings
- S7004037 - Floor Support Brackets and Bolts
- S7004033 - Basin fixing Bolt Set. (All Olympus basins can be Bolted Directly to a Solid Wall with this Set of Fixings)

**Mirage Concealed Cistern**



- S2156501** - Mirage Concealed L/L Cistern with Type 'P' Lever Kit
  - S2156511** - Mirage Concealed L/L Cistern with Type 'W' Lever Kit
  - S2156521** - Mirage Concealed L/L Cistern with Type 'A' Lever Kit
  - S2156551** - Type 'A' Lever Kit Only
- 'P' Kit - For Duct Thickness 12-60mm  
 'W' Kit - For Wall Thickness 114mm  
 'A' Kit - Combined Wall and Duct Thickness upto 390mm

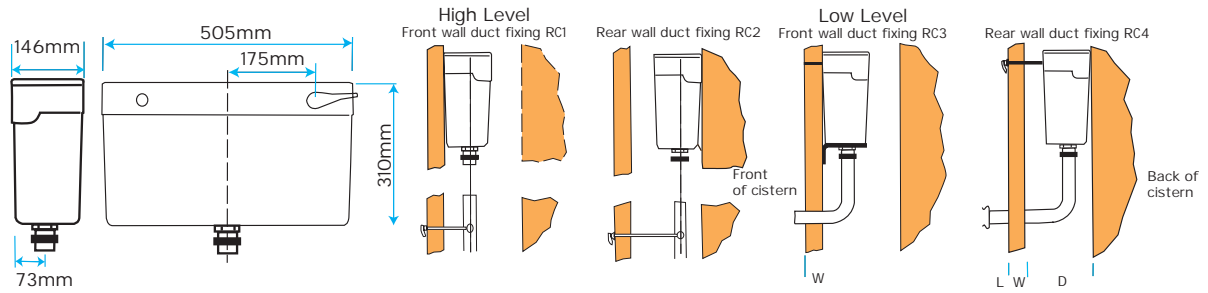

**Phantom Concealed Cistern - Top Access**



- S2156531** - Phantom Concealed L/L Cistern with Air Assisted Push Button Control C.P. Push Button S.I.S.O.
- S2156532** - Phantom Concealed L/L Cistern with Air Assisted Push Button Control C.P. Push Button B.I.B.O.

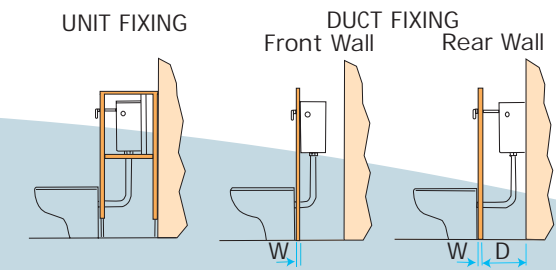

**Vantage Concealed Cistern - Front & Top Access**



- S52156533** - Vantage Concealed L/L Cistern with Air Assisted Push Button Dual Flush Control C.P. Push Button
- Available to order with single flush control

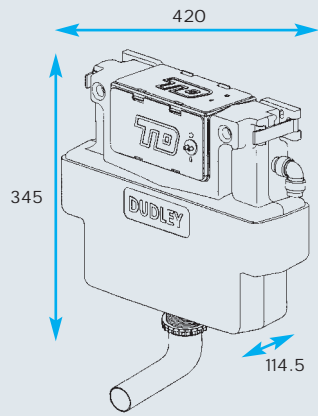



**N&C**  
*Olympus*

# Olympus

## Designer Range

**C/C W.C. Suite Standard Height (Push Button Flush)**

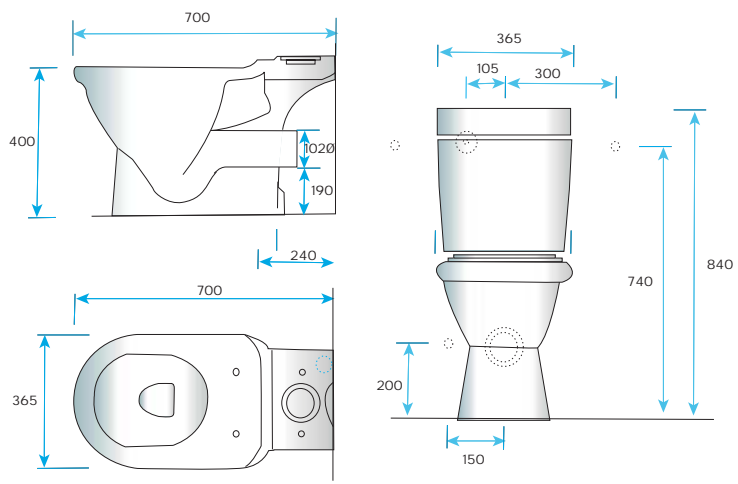

- S7004060 - OL81 H.O. C/C W.C. Pan**
- S7004063 - OL83 Seat and Cover Stainless Steel Hinges**
- S7004061 - OL82 C/C Cistern Shell (BS+O)**
- S7004062 - Push Button Fittings Pack (Internal Overflow)**

**Floor Standing Bidet**

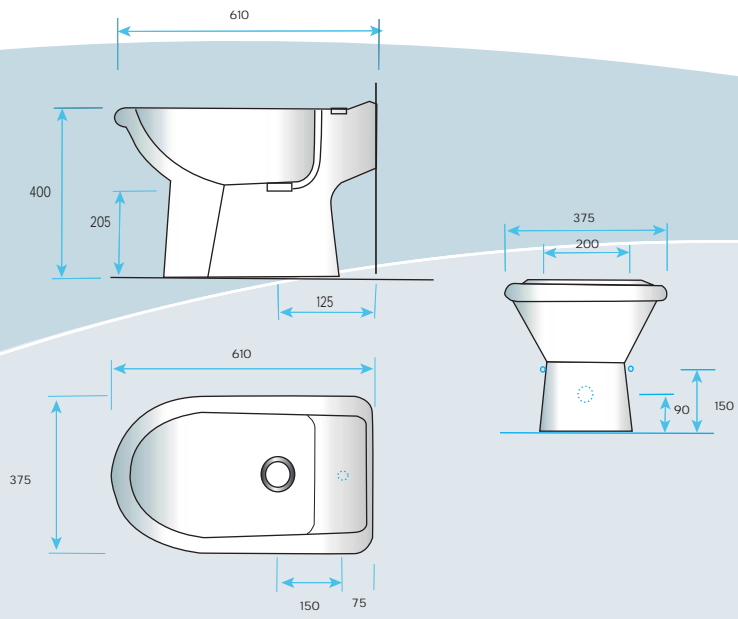

- S7004064 - OL84 Bidet (Taphole 1)**

The Taps and Mixers Featured are shown within our Olympus Brassware Ranges See Page 53



**Basin and Pedestal**

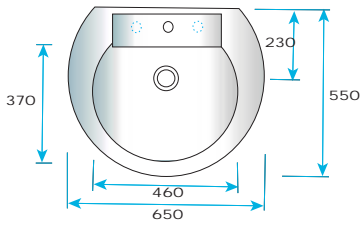
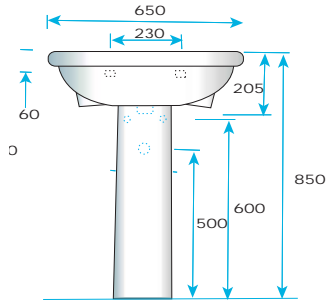

- S7004065 - OL85 65cm Basin (Taphole 1)
- S7004066 - OL86 65cm Basin (Taphole 2)
- S7004067 - OL87 Full Pedestal



**Basin and Semi Pedestal**

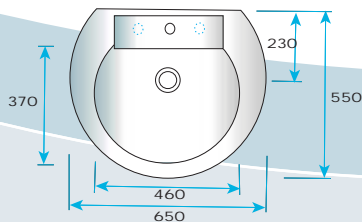
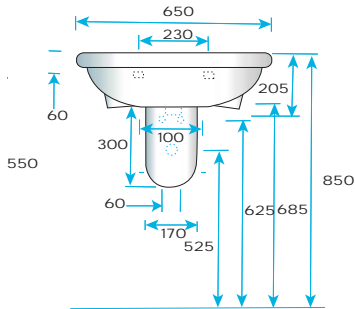

- S7004065 - OL85 65cm Basin (Taphole 1)
- S7004066 - OL86 65cm Basin (Taphole 2)
- S7004068 - OL88 Semi Pedestal



**Olympus**

Designer Range

The Taps and Mixers Featured are shown within our Olympus Brassware Ranges See Page 53

**Basin and Pedestal**

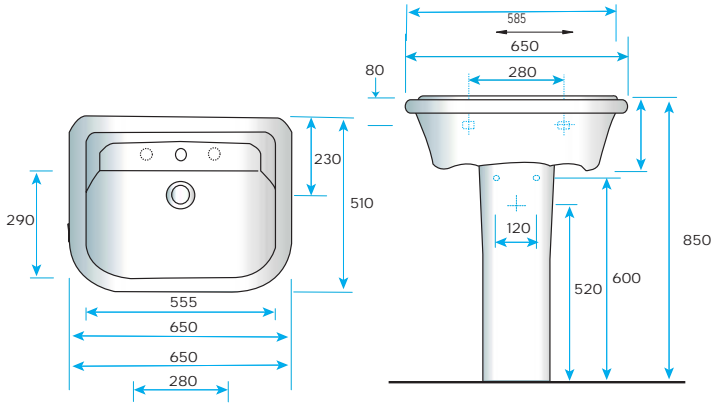

- S7004069 - OL89 65cm Basin (Taphole 1)
- S7004070 - OL90 65cm Basin (Taphole 2)
- S7004071 - OL91 Full Pedestal

**Basin Fixings**

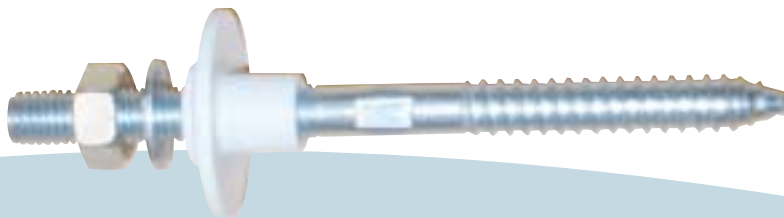

**Fixing Bolts**

S7004033 - Basin Fixing Bolt Set. (All Olympus Basins can be Bolted Directly to a Solid Wall with this Set of Fixings)



The Taps and Mixers Featured are shown within our Olympus Brassware Ranges See Page 53

**N&C**  
*Olympus*



Olympus

Broadgate Range

**H.O C/C W.C. Suite Standard Height (Lever Flush)**

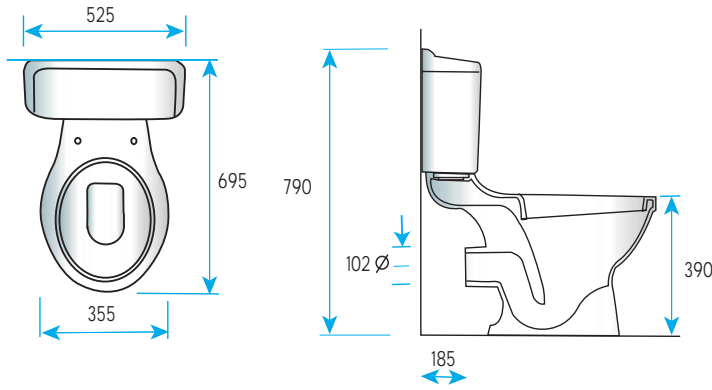

- S7006004 - OL53 C/C HO WC Pan
- S7006005 - OL54 C/C Cistern Shell (B.I.B.O)
- S7006006 - Lever Cistern Fitting Pack (Internal Overflow)

**H.O C/C W.C. Suite Standard Height (Push Button)**

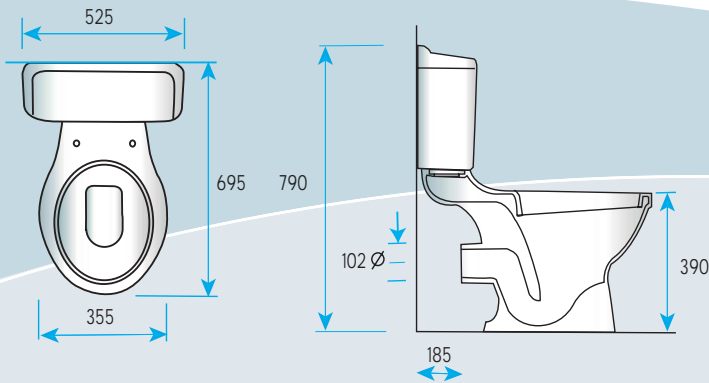

- S7006004 - OL53 C/C HO WC Pan
- S7006007 - OL55 C/C Cistern Shell (B.I.B.O)
- S7006008 - Push Button Cistern Fitting Pack (Internal Overflow)

For our Selection of Toilet Seats See Page 153-154

**Floor Standing Bidet**

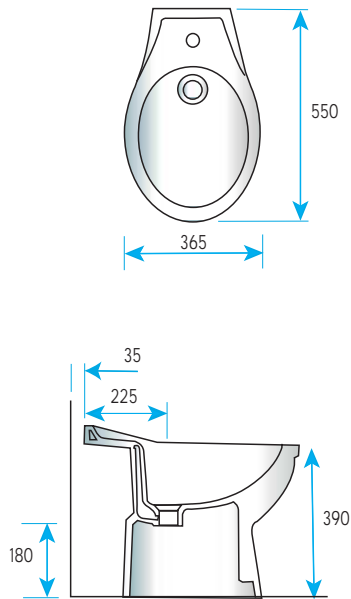

**S7006009 - OL92 Bidet (Taphole 1)**

**Basin and Pedestal**

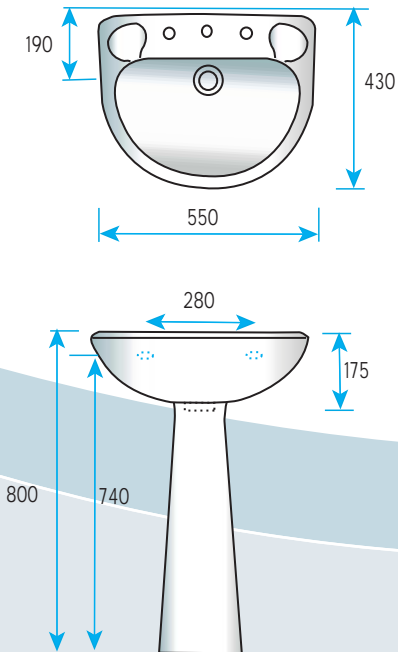

**S7006001 - OL50 55cm Basin (Taphole 1)**  
**S7006002 - OL51 55cm Basin (Taphole 2)**  
**S7006003 - OL52 Pedestal**

The Taps and Mixers Featured are shown within our Olympus Brassware Ranges See Page 53



## Cloakroom Basin

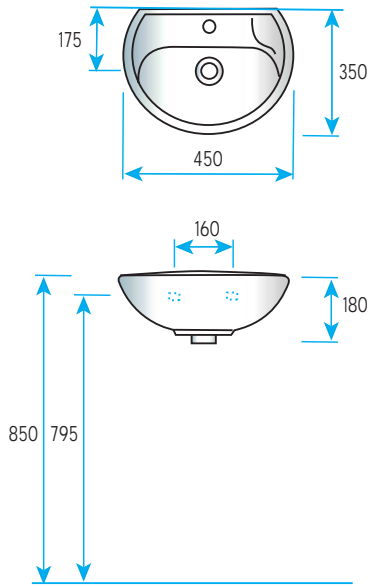

- S7006017 - OL93 45cm Basin (Taphole 2)
- S7006018 - OL94 45cm Basin (Taphole 1)
- S2068501 - Hanger Brackets

## Bath

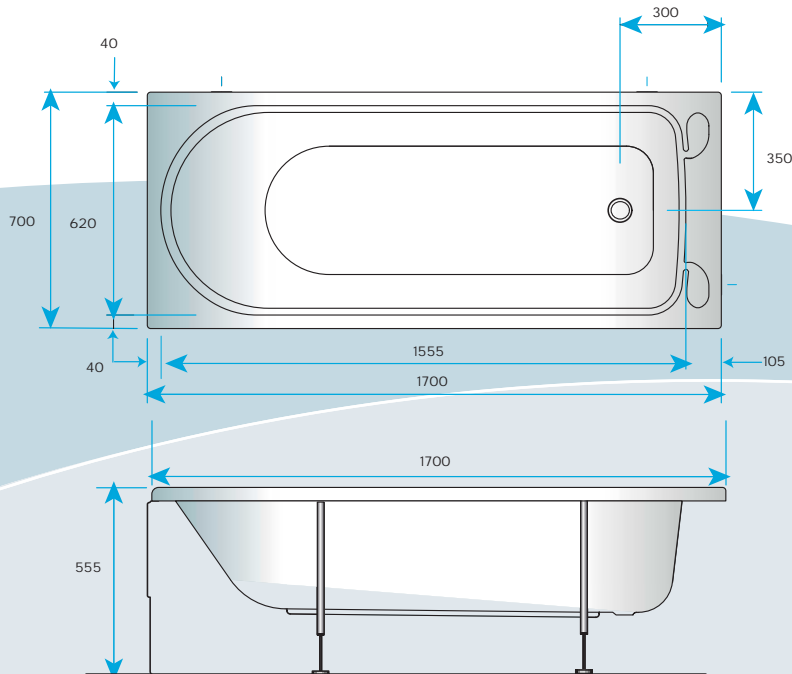

- S7006107 - 170 x 70cm 5mm Acrylic Bath

### Bath Panels

- S2000161 - 170cm Broadgate Acrylic Front Panel
- S2000171 - 70cm Broadgate Acrylic End Panel

The Taps and Mixers Featured are shown within our Olympus Brassware Ranges See Page 53

**N&C**  
*Olympus*



# Olympus

## Commercial Range

**Back to Wall H.O W.C. Pan**

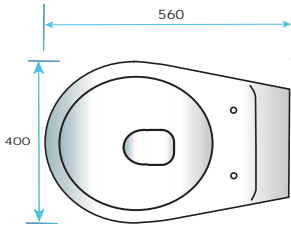
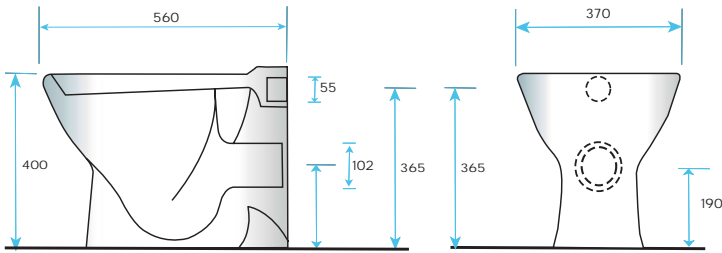

- S7004005 - OL4 Back to Wall H.O W.C. Pan Standard Height**
- S7004032 - OL50 Seat and Cover (Top Fixing Stainless Steel Hinges)**

(For Concealed Cistern Options See Page 26)

**Wall Basin with Overflow**

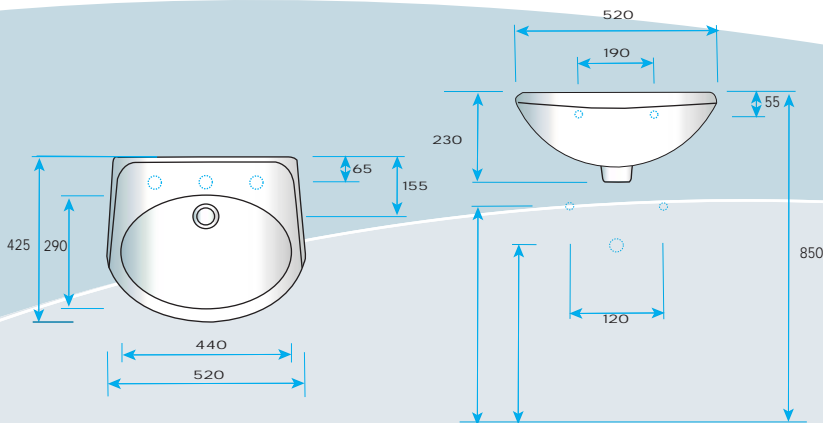

- S7004020 - OL30 Wall Basin (Taphole 1) with Overflow 52cm**
- S7004021 - OL34 Wall Basin (Taphole 2) with Overflow 52cm**
- S7004036 - Combined Hanger and Waste Bracket**

The Taps and Mixers Featured are shown within our Olympus Brassware Ranges See Page 53



**Wall Basin with Overflow**

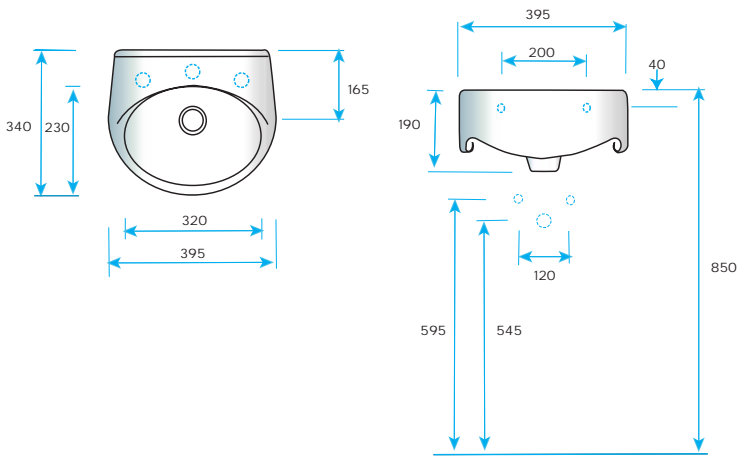

**S7004019 - OL29 Wall Basin (Taphole 1) with Overflow 39cm**  
**S7004018 - OL19 Wall Basin (Taphole 2) with Overflow 39cm**  
**S7004034 - Hanger Brackets**

**Corner Basin Wall Fixed**

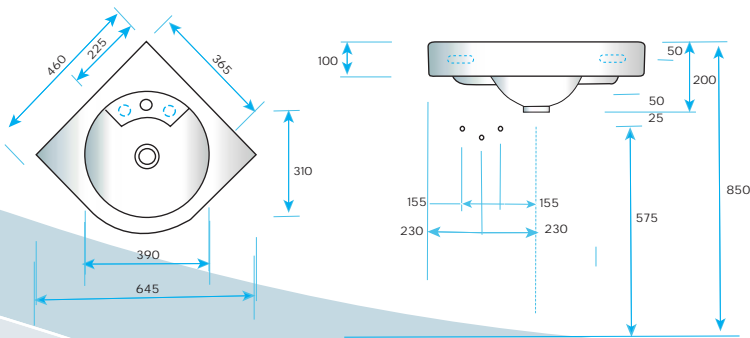

**S7004012 - OL15 46cm Corner Basin (Taphole 1) Wall Fixed**  
**S7004013 - OL16 46cm Corner Basin (Taphole 2) Wall Fixed**  
**S7004034 - Hanger Brackets (2pr Required for Each Basin)**

The Taps and Mixers Featured are shown within our Olympus Brassware Ranges See Page 53

**Olympus**

Commercial Range

**Corner Basin Wall Fixed**

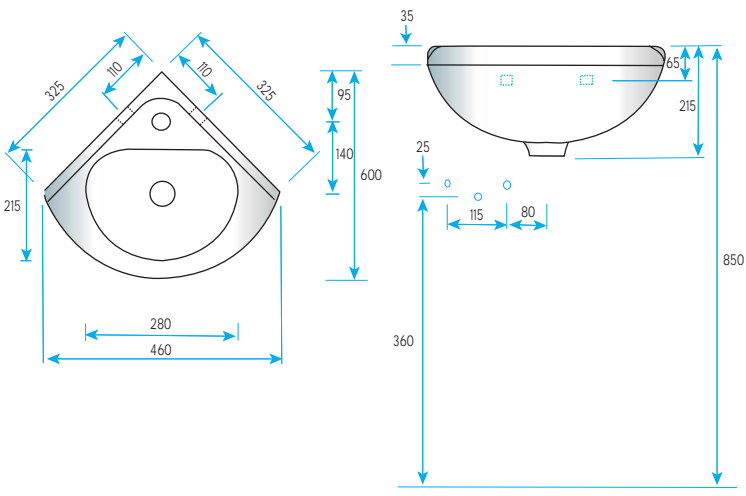

**S7004015 - OL26 32cm Corner Basin (Taphole 1) Wall Fixed**  
**S7004034 - Hanger Brackets**

**Concealed Trap Urinal Bowl**

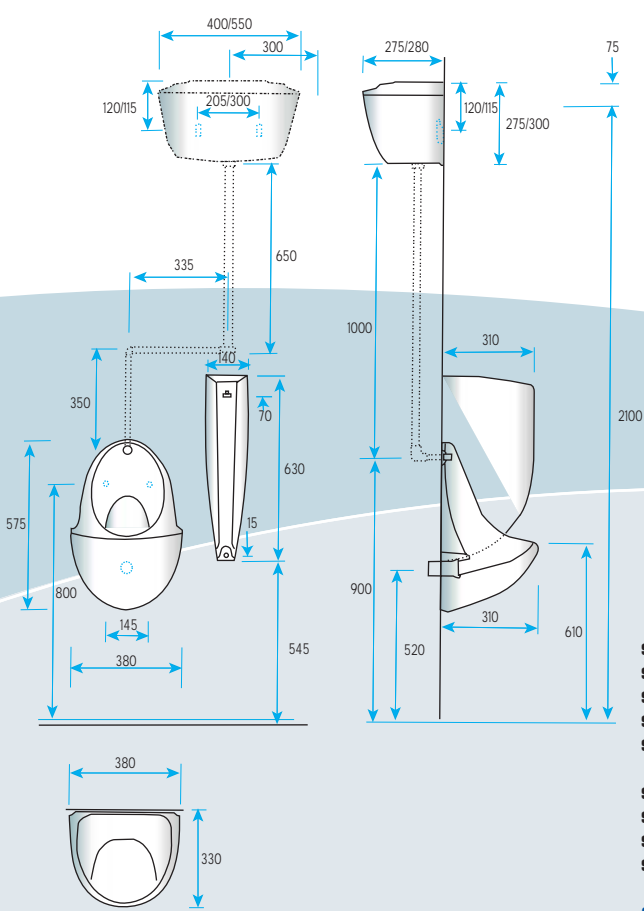

**S7004044 - OL38 Concealed Trap Urinal Bowl**  
**S7004028 - OL23 Urinal Division**  
**S2199031 - 4.5 Ltr Concealed Plastic Auto Cistern**  
**S2199032 - 9.0 Ltr Concealed Plastic Auto Cistern**  
**S2199033 - 13.5 Ltr Concealed Plastic Auto Cistern**  
**S2195501 - Concealed Pipes & Spreaders (1 person)**  
**S2195511 - Concealed Pipes & Spreaders (2 person)**  
**S2195521 - Concealed Pipes & Spreaders (3 person)**  
**S2195531 - Concealed Pipes & Spreaders (4 person)**

**(Urinal Bowl and Division, Supplied C/W Hangers)**

For Waste Fittings and Traps See Page 228-229

**Top Inlet Urinal Bowl**

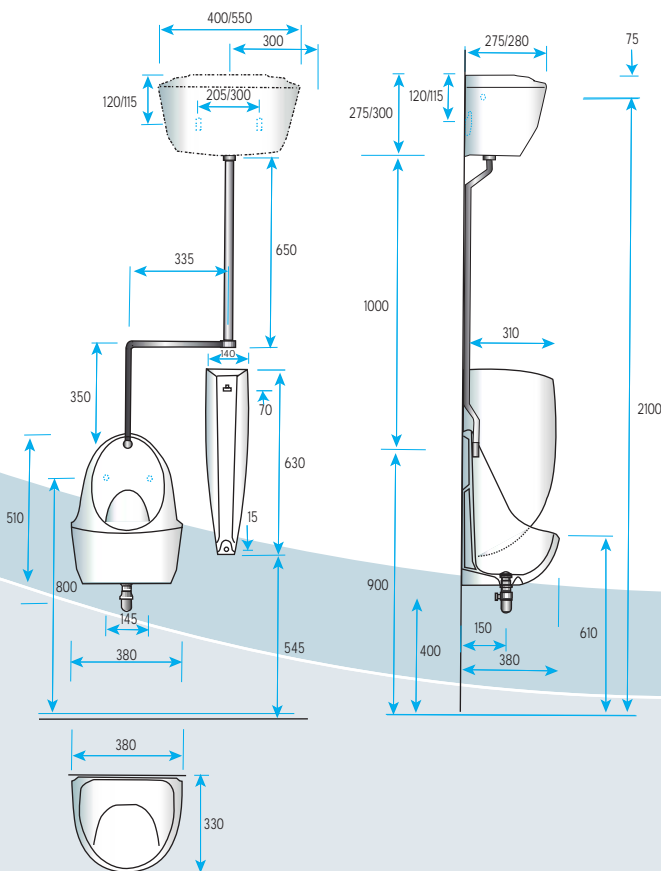

- S7004027 - OL22** Top Inlet Urinal Bowl
- S7004028 - OL23** Urinal Division
- S7004029 - OL28** Automatic Cistern Shell only
- S2199571 - 4.5ltr** Auto Syphon
- S2199572 - 9.0ltr** Auto Syphon
- S2199573 - 13.5ltr** Auto Syphon

- S2195001 - Exposed Pipes & Spreaders (1 person)**
- S2195011 - Exposed Pipes & Spreaders (2 person)**
- S2195021 - Exposed Pipes & Spreaders (3 person)**
- S2195031 - Exposed Pipes & Spreaders (4 person)**

(Urinal Bowl and Division, Supplied C/W Hangers)

**Urinal Fixings**

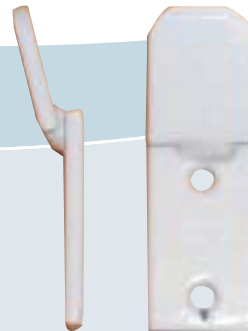

**S7004035 - Hanger Brackets (To Suit OL28)**

For Waste Fittings and Traps see Page 228-229

**Corner Urinal Bowl**

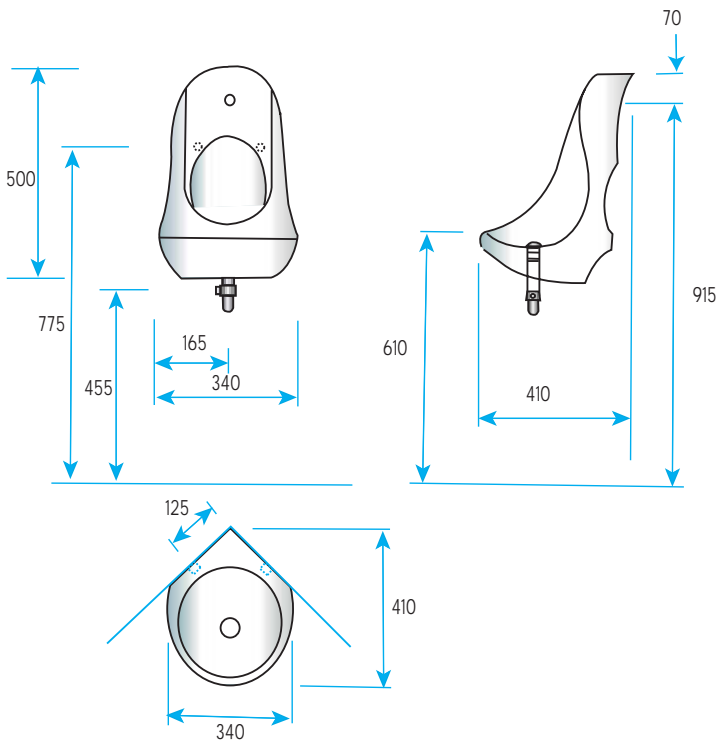

**S7004072 - OL95 Corner Urinal Bowl**

**Basin Fixings and Brackets**

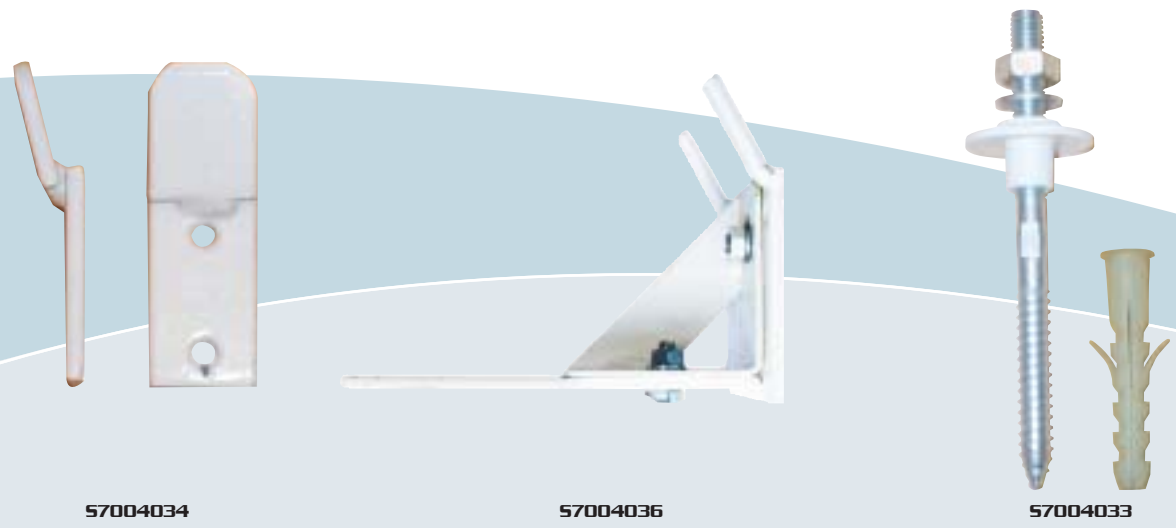

**S7004034**

**S7004036**

**S7004033**

**Fixing Brackets**

- S7004034 - Basin Hangers**
- S7004036 - Adjustable Hanger and Waste Bracket with Basin Fixings**
- S7004033 - Basin Fixing Bolt Set. (All Olympus Basins can be Bolted Directly to a Solid Wall with this Set of Fixings)**

For Waste Fittings and Traps See Page 228-229

**Belfast and Cleaners Sinks**

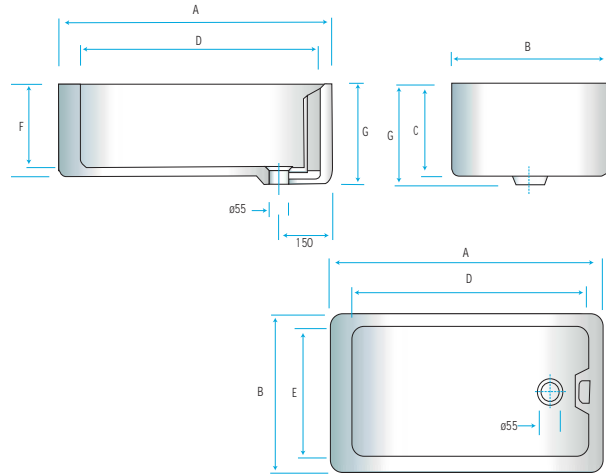
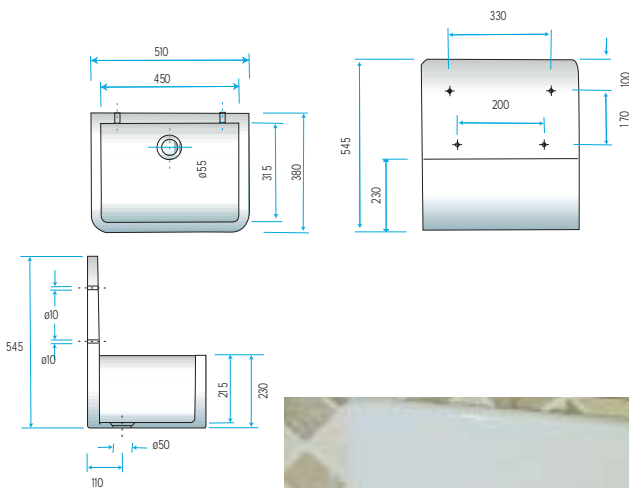

**Belfast Sinks**

- S7004050 - OL70 760 x 455 x 255 mm Belfast Sink**
- S7004051 - OL71 610 x 455 x 255 mm Belfast Sink**
- S7004052 - OL72 455 x 380 x 205 mm Belfast Sink**

	A	B	C	D	E	F	G
LARGE	760	450	255	675	365	245	280
MEDIUM	615	460	255	540	385	235	280
SMALL	455	375	210	380	300	195	235

**Cleaners Sink**

- S7004053 - OL73 High Back Cleaners Sink 510 x 380 x 230 mm C/W S/Steel Bucket Grating**

**Brackets and Legs for Above**



- S2204001 - 455mm Projection Built in Brackets P.C.I.**
- S2204011 - 405mm Projection Built in Brackets P.C.I.**
- S2204021 - 355mm Projection Built in Brackets P.C.I.**

- S2204501 - 405mm Projection Legs and Bearers for Belfast Sink P.C.I.**
- S2204511 - 355mm Projection Legs and Bearers for Belfast Sink P.C.I.**

- S2205001 - 355mm Projection Legs and Bearers for Cleaners Sink P.C.I.**

For Waste Fittings and Traps See Page 228-229



**Childrens Height W.C. Pan. H.O.**

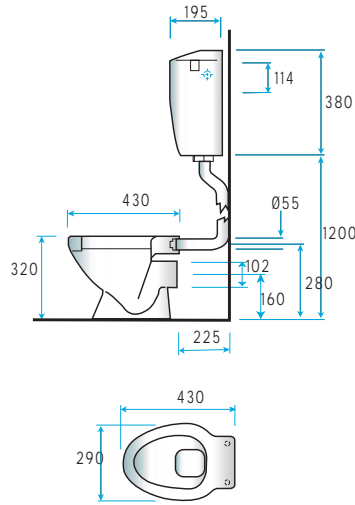

- S7004045 - OL39 305mm H.O. Childrens W.C. Pan
- S2163501 - White Low Level Trishell Cistern and Fittings (S.I.S.O)
- S2163502 - Black Low Level Trishell Cistern and Fittings (S.I.S.O)
- S2182501 - White Single Open Front Seat
- S2182511 - Black Single Open Front Seat

**Asian W.C Pan and Trap**

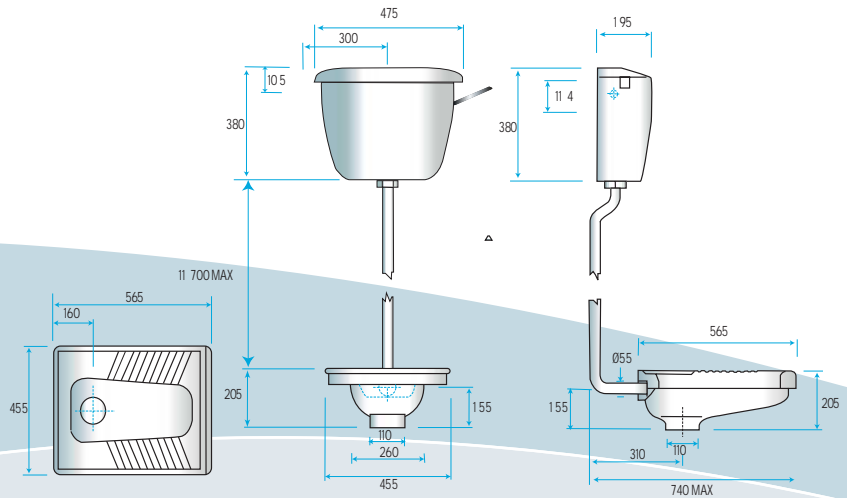

**S7004047 - OL47 Asian Squatting Pan with Back Inlet**

**S7000048 - OL48 'P' Trap Outlet**

**S7000049 - OL49 'S' Trap Outlet**



For Cistern and Flush Pipe Options See Page 143 and 151



# Olympus

## Phlexicare Range

**Pentland RAISED HEIGHT Back to Wall H.O. W.C. Pan**

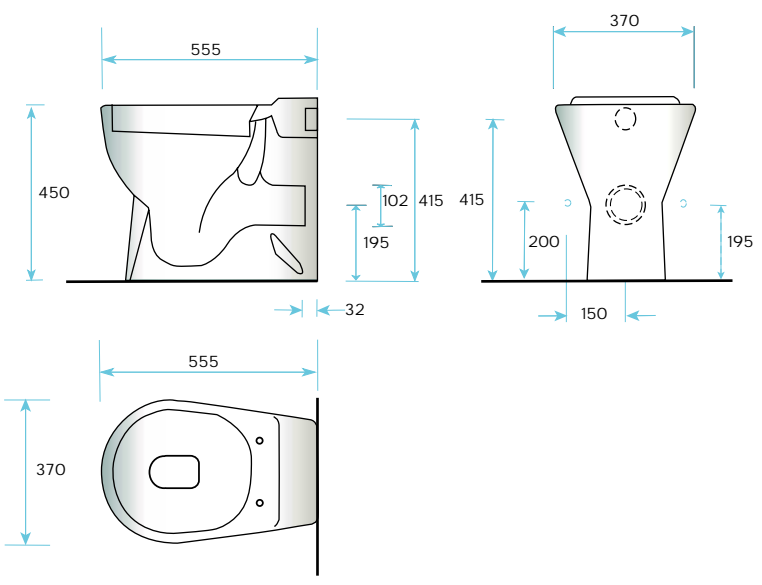

- P7004004** - OL5 45cm Raised Height Low Level Back to Wall W.C Pan
- S2156521** - Concealed Cistern SISO Type A Kit 6 Litre Flush
- P6830821** - Concealed Spatulate Lever Chrome

**Alternative Cistern**

- S7004038** - OL43 Low Level Cistern Shell Only (S.S.O)
- S7004039** - Cistern Fittings Pack Chrome Lever (Internal Overflow)
- P6830810** - Spatulate Lever Chrome
- S2177001** - 760 x 305mm Extended Flush Bend

**Pentland RAISED HEIGHT H.O C/C W.C. Suite**

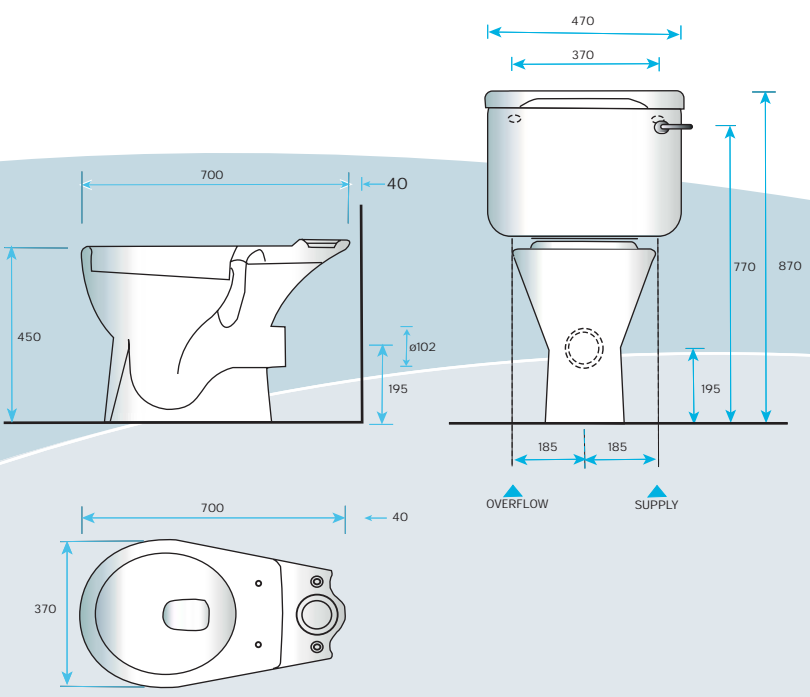

- P7004001** - OL2 45cm Raised Height H.O C/C W.C. Pan
- P7004002** - OL31 Close Coupled Cistern with Reversible Lever Shell Only
- P7004003** - Close Coupled Cistern Fittings Pack with CP Spatulate Lever, 6 Litre Flush (Internal Overflow)

For our selection of Toilet Seats See Page 108



**Throne Toilet Grab Rail System**



**P6833832 - Standard Toilet Grab Rail System**



**P6833833 - Wrap-Around Toilet Grab Rail System**

**Wall Basin No Overflow No Chain Hole**

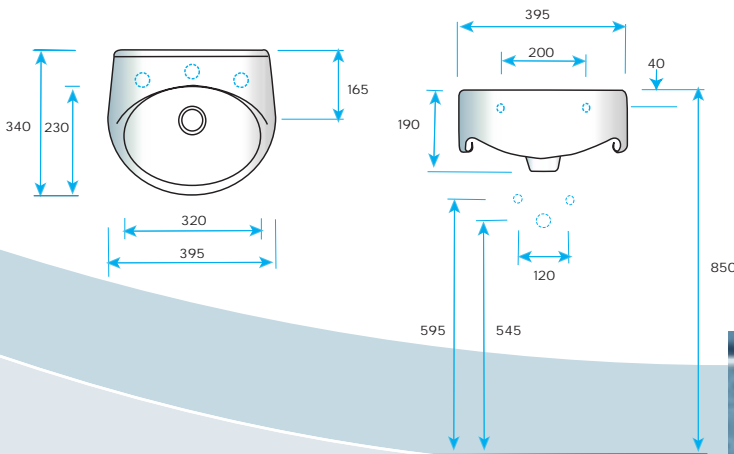

- P7004008 - OL18 Wall Basin (Taphole 1) No Overflow No Chain Hole 39cm**
- P7004009 - OL40 Wall Basin (Taphole 2) No Overflow No Chain Hole 39cm**
- P7004012 - Hanger Brackets**
- P7004013 - Adjustable Waste Bracket**
- P6840901 - Chrome Lever Spray Mixer Tap**

**Shampoo Basin**

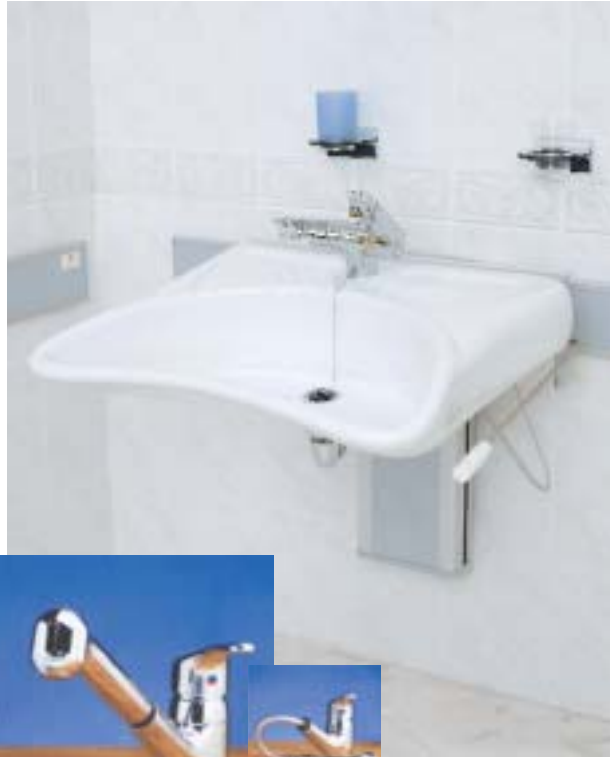
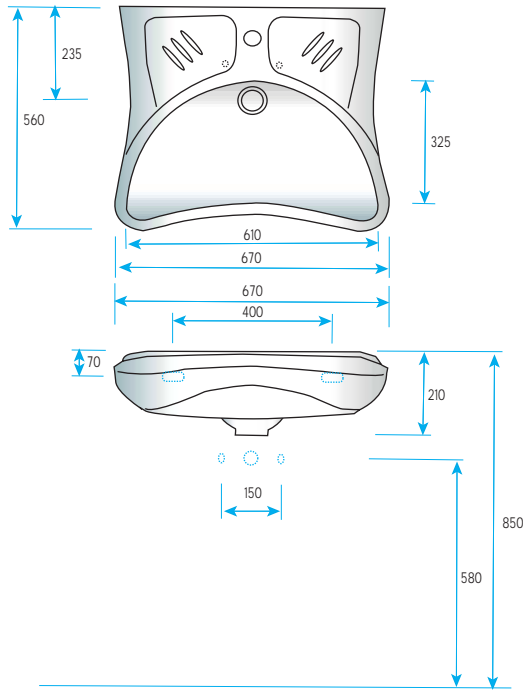

**P7004010 - OL20 Shampoo Basin (Taphole 1)  
(C/W Wall Fixings)**

**P6848002 - Monobloc Shampoo Mixer**

(For Height Adjustable Mechanism. See Page 102 and 106)

**Shampoo Basin**

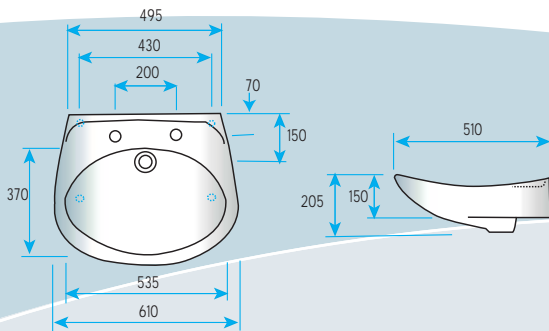

**S2105001 - Shampoo Basin (Taphole 2)**

**S2105011 - Monobloc Mixer Tap with Retractable Hose and Spray**

**S2105021 - 32mm Chrome Strainer Waste with Lift Out Grid**

**Pair Fixed Height Support Brackets**

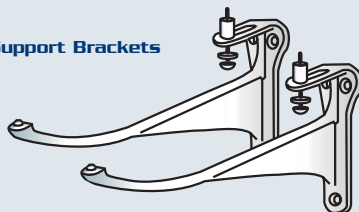

**Fixings**

**S2105031 - Pair Fixed Height Support Brackets**

**P6811322 - Wash Basin Connecting Bracket with Toggle Bolts  
(for Use with Adjustable Assemblies)**

(For Height Adjustable Mechanism. See Page 102 and 106)

The Taps and Mixers Featured are Shown Within our Olympus Brassware Ranges See Page 53



## Beaumonde Wash Basin

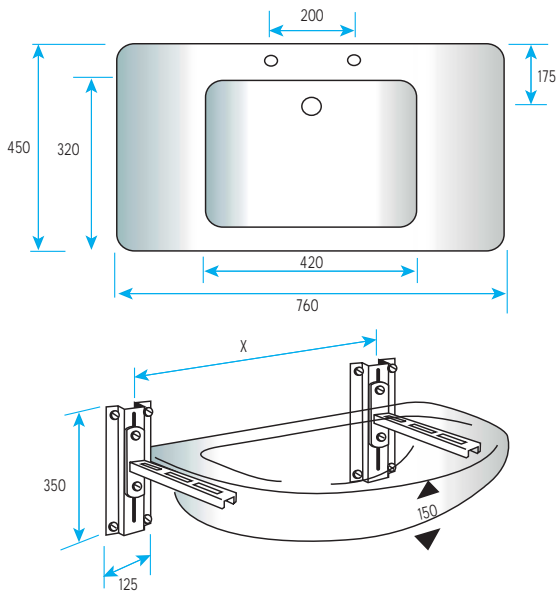

Adjustable Support Brackets allows for 150mm height adjustment

**P6810101 - OL45 760x480mm (Taphole 2)**

### Fixings

**P6810611 - Adjustable Support Brackets**



(For Height Adjustable Mechanism. See page 102 and 106)

## Adjustable Height Wash Basin

mm	a	b	c	d	e	h	j	k
600	600	480	185	200	55	280	530	330
550	550	450	185	180	45	280	470	295

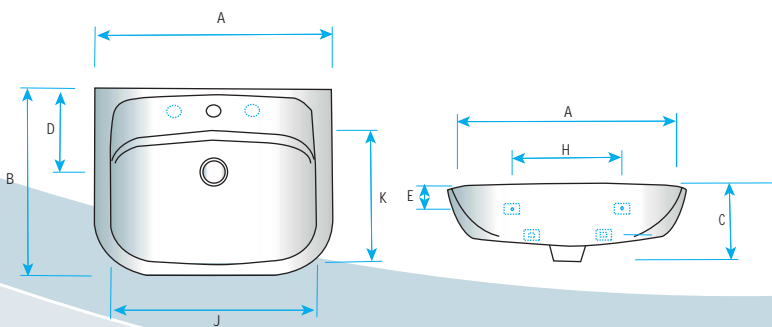

- P7004005 - OL11 60cm Basin (Taphole 1)**
- P7004006 - OL12 60cm Basin (Taphole 2)**
- P7004016 - OL27 55cm Basin (Taphole 1)**
- P7004017 - OL33 55cm Basin (Taphole 2)**

(For Height Adjustable Mechanism. See page 102 and 106)



The Taps and Mixers Featured are Shown within our Olympus Brassware Ranges See Page 53

**Document M Design Criteria**

Phlexicare Range



N & C Phlexicare are acknowledged leaders in the design and supply of Toilet Equipment complying with Document 'M' of The Building Regulations.

One of the most potentially embarrassing moments in life can be going to the toilet. But now we have the means to make people's lives a little easier, more dignified and less of a problem. This catalogue's ranges demonstrate new approaches and fresh solutions to old problems.

Careful attention to detail is required in ensuring that Document 'M' is complied with and particular attention should be given to the toilet seat height.

All Phlexicare's suggested packages comply in every detail.

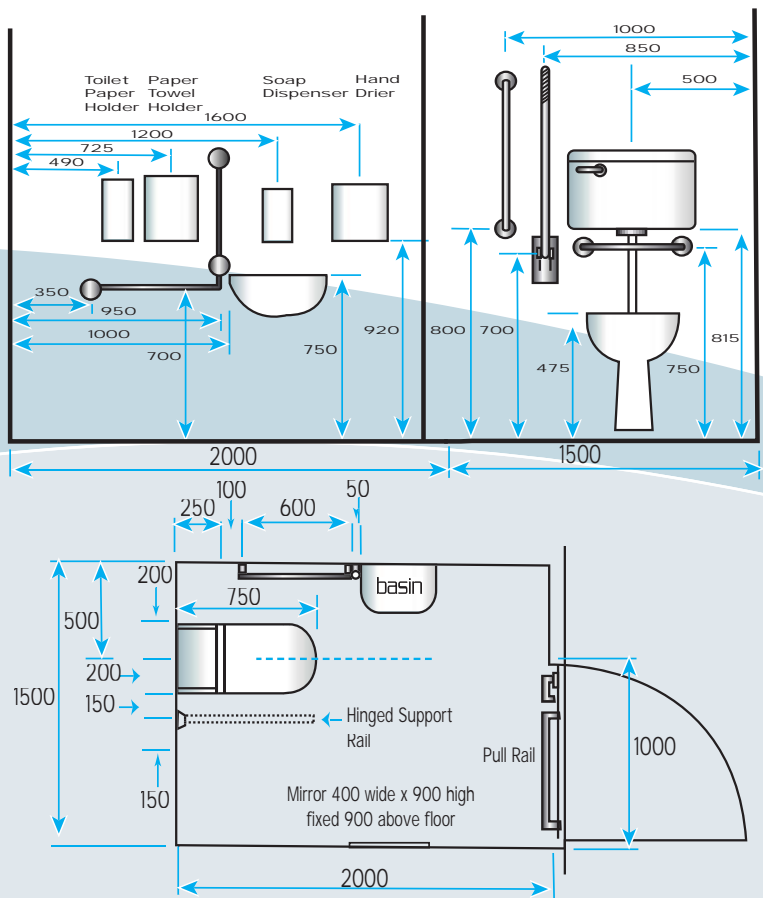

## Olympus Classic Document M Toilet Package

The Olympus Classic Document M is the ideal package for any environment. Providing a standard layout for wheelchair users and also giving maximum wheelchair manoeuvrability.

- Olympus Pentland white vitreous china 450mm W.C pan
- 6 litre white plastic low level cistern with CP spatulate lever
- Flush bend 760 x 305mm
- White Dania seat and cover
- Olympus white vitreous china hand rinse basin size 395 x 340mm with centre taphole without overflow hole
- Adjustable waste support bracket
- Pair of concealed hangers
- Lever action spray mixer tap chromed finish
- 32mm chromed grated basin waste
- 32mm chromed plastic bottle P trap



**P6830045** - White Rails  
**P6830046** - Red Rails

Alternative Cistern

**P6830047** - White Rails with Vitreous China Cistern  
**P6830048** - Red Rails with Vitreous China Cistern

### GRAB RAILS

- Single folding arm 750mm
- 600 x 600mm 90° grab rail
- 600mm straight grab rails (x2)
- 400 x 250mm back rest rail

## Olympus Economy Document M Toilet Package

- White vitreous china low level 450mm W.C pan
- 6 litre white vitreous china low level cistern shell
- 6 litre cistern package of fittings
- White flush bend 760x305mm
- Chromed spatulate cistern lever
- White Dania single flap seat
- Olympus white vitreous china hand rinse basin size 395 x 340mm with centre taphole without overflow hole
- Adjustable Waste support bracket
- Pair of concealed hangers
- Lever action spray mixer tap chromed finish
- 32mm chromed grated waste
- 32mm chromed plastic bottle P trap



**P6830050** - Olympus Economy Document M Toilet Package

### GRAB RAILS

- White Single Folding Arm 750mm
- White 600 x 600mm 90° Angle Grab Rail
- White 600mm Straight Grab Rail (x2)
- White 400 x 250mm Back Rest Rail

For Accessories See Page 52

## Olympus Blue Document M Toilet Package

- Olympus Pentland white vitreous china 450mm close coupled pan
- Olympus Pentland white vitreous china cistern shell for reversible lever
- Olympus close coupled cistern 6 litre flush with spatulate lever
- Blue Dania seat and cover
- Olympus white vitreous china basin size 395 x340mm with centre taphole, without overflow
- Waste support bracket
- Pair of concealed hangers
- Lever action spray mixer tap chromed finish
- 32mm chromed grated waste
- 32mm chromed Plastic Bottle P Trap



P6830051 - Olympus Blue Document M Toilet Package

### GRAB RAILS

- Blue ABS 600mm straight grab rails (x4)
- Blue Rehab folding rail 850mm

## Olympus Blue Document M Toilet Package (Low Level)

- Olympus Pentland white vitreous china 450mm W.C pan
- 6 litre white vitreous china low level cistern shell
- 6 litre cistern package of fittings
- White PVC flush bend 760x305mm
- Chromed spatulate cistern lever
- Blue single flap Dania seat
- Olympus white vitreous china basin size 395x340 with centre taphole no overflow
- Waste support bracket
- Pair of concealed hangers
- Lever action spray mixer tap
- 32mm chromed grated waste
- 32mm chromed Plastic Bottle P Trap



P.68300.52 - Olympus Blue Low Level Document M Toilet Package

### GRAB RAILS

- Blue ABS 600mm straight grab rails (x4)
- Blue Rehab folding rail 850mm
- Blue 400 x 250mm back rest rail

For Accessories See Page 52



**BS 8300 Accessible Toilet Package**

- Olympus Pentland white vitreous china 450mm raised height back to wall pan
- 6 litre vitreous china low level cistern shell 550
- 6 litre cistern package of fittings
- PVC extended flush bend 760 x 305mm
- Chrome spatulate cistern lever
- Dania blue ring seat
- Blue back rest rail
- Padded back support
- Olympus hand rinse basin, two Tapholes, no overflow, but with Taphole stopper
- Hangers and adjustable waste bracket
- Chrome spray mixer tap and grated waste with bottle trap
- Blue abs grab rail (Five)
- Blue rehab folding rail
- White plastic colostomy bag shelf
- White plastic shelf
- Visual alarm



**OPTIONAL EXTRAS (SEE PAGE 52)**

- Hand drier • Soap Dispenser • Toilet Tissue Dispenser • Paper Towel Dispenser
- Mirrors

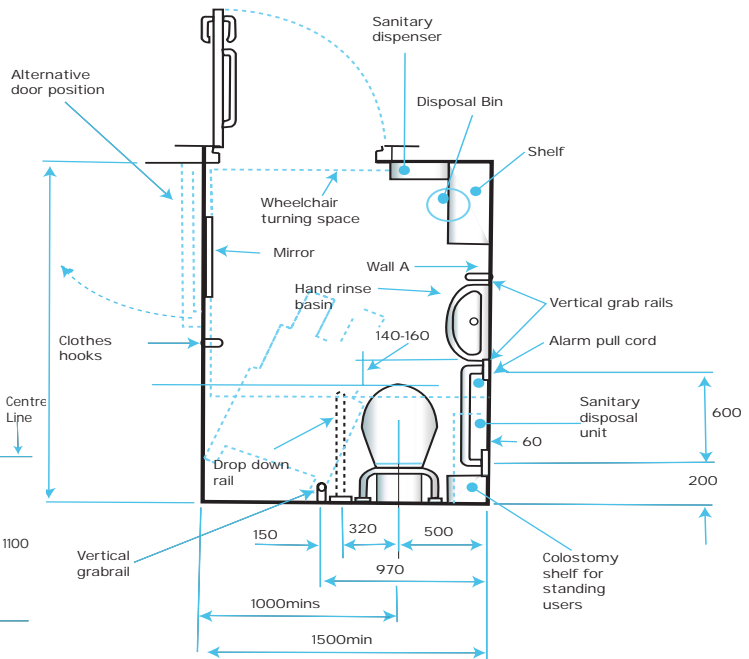
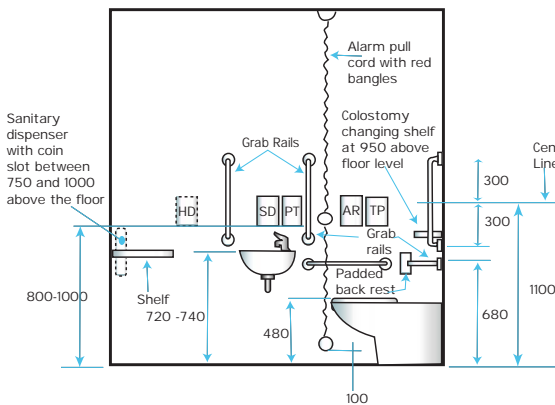

**P6830054 • Accessible Toilet Package to BS8300 Specification**

**Document M Fixings and Brackets**

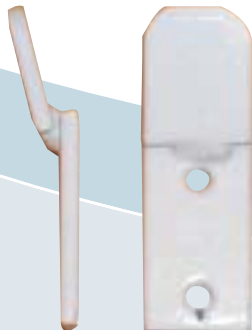

**P7004012**



**P7004013**

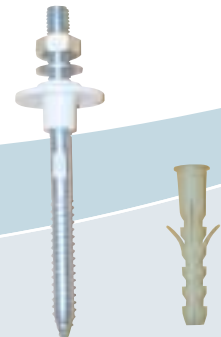

**S7004033**

**Fixing Brackets**

**P7004012 • Basin Hangers**

**P7004013 • Adjustable Waste Bracket**

**P7004033 • Basin Fixing Bolt Set. (All Olympus Basins can be Bolted Directly to a Solid Wall with this set of Fixings)**



## Accessories for Document M Packages

**P6830040 - Olympus Accessories Package for Document M Toileting**

**Soap Dispenser**



**Toilet Tissue Dispenser**



**Paper Towel Dispenser**



**S2940001 - Hand Drier**



**P6441011 - Audio Visual Wireless Alarm**



**S2941001 - Hand & Face Drier**



## Spatulate Cistern Flush Lever

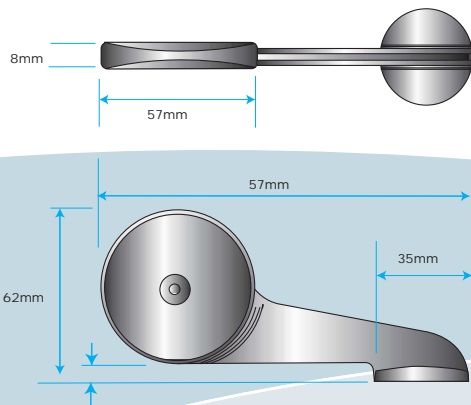

There is nothing more embarrassing to many people than to be unable to flush the toilet due to weak hands or painful joints. Our Spatulate Cistern Flush Lever requires approximately 25% of the effort usually required by a standard lever.

**P6830810 - Spatulate Lever, Chrome**

**P6830821 - Concealed Spatulate lever, Chrome**  
 (adjustable to wall thicknesses 32mm - 300mm)

## Cistern Foot Control



Should it be difficult or impossible to operate a standard lever flush cistern, we can provide a foot operated cistern control. Our foot control can be ordered as an extra item but will only suit the Phantom pushflo concealed cistern S2156531 and S2156532. See page 144 for details.

**P6830813 - Foot Operated Cistern Control only to suit Phantom Cistern**

**N&C**  
*Olympus*



# Olympus

## Brassware Ranges

**Jade**



**Built in Bath Mixer** (Kit Extra see Below)  
**S7007103 - Chrome Finish**



**Built in Basin Mixer**  
**S7007102 - Chrome Finish**

Jade Range



**Basin Mixer with Pop-up Waste**  
**S7007100 - Chrome Finish**



**Bidet Mixer with Pop-up Waste**  
**S7007101 - Chrome Finish**



**Kit 1, Hose, Handset & Wall Bracket**  
**S7007009 - Chrome Finish**



**Kit 2, Hose, Handset & Sliding Rail**  
**S7007010 - Chrome Finish**

JADE QUARTER TURN CERAMIC DISC LUXURY BRASSWARE

FINISH



CHROME

**Athena**



**Bath Pillar Taps**  
 S7007005 - Chrome Finish - Pair



**Basin Mixer with Pop-up Waste**  
 S7007001 - Chrome Finish



**Basin Pillar Taps**  
 S7007004 - Chrome Finish - Pair



**Bidet Mixer with Pop-up Waste**  
 S7007006 - Chrome Finish



**Basin Mixer Raised Spout with Pop-up Waste**  
 S7007002 - Chrome Finish



**Basin Mixer Vertical Spout with Pop-up Waste**  
 S7007003 - Chrome Finish

Athena Range

ATHENA QUARTER TURN CERAMIC DISC LUXURY BRASSWARE

FINISHES



CHROME



CHROME/GOLD Mixage (to order only)

**Athena**



**2 Hole Bath Filler Deck Mounted**  
 S7007008 - Chrome Finish



**2 Hole Bath/Shower Mixer Deck Mounted**  
 (Kit extra see below)  
 S7007007 - Chrome Finish

Athena Range



**Kit 1, Hose, Handset and Wall Bracket**  
 S7007009 - Chrome Finish



**Kit 2, Hose, Handset and Sliding Rail**  
 S7007010 - Chrome Finish

ATHENA QUARTER TURN CERAMIC DISC LUXURY BRASSWARE

FINISHES



CHROME



CHROME/GOLD Mixage (to order only)



## Nova Palma

A range of competitively priced high quality taps with a number of special features. Easy to fit, simple to operate and heavy-duty cast metal hand wheels ensure years of use. Made of brass to BS 5412.



### Monobloc Basin Mixer

Suitable for wash basin with one taphole. Connectors-13mm BSP. Combined pop-up waste-32mm.

S.23110.01 - Mono Basin Mixer  
 Chrome Finish



### Monobloc Sink Mixer

Suitable for kitchen sinks with one taphole. Swivel nozzle with 230mm projection. Connectors-13mm BSP.

S2313001 - Mono Sink Mixer  
 Chrome Finish



### Bath and Shower Mixer

Automatic safety diverter from shower to bath. Shower kit supplied includes chrome flexible hose, handset and wall bracket.

S2310001 - Bath Mixer and Shower Kit  
 Chrome Finish



### Bath and Basin Taps

S2310501 - Bath Taps Chrome Finish - Pair  
 S2311501 - Basin Taps Chrome Finish - Pair



### Deck Sink Mixer

Suitable for any conventional 2-hole kitchen sink. The nozzle swivels and projects into the sink 165mm.

S.23135.01 - Deck Sink Mixer  
 Chrome Finish



### Sink Pillar Taps

S.23140.01 - Sink Pillar Taps  
 Chrome Finish - Pair

FINISH



CHROME

**Diamonte**

Add a touch of class to your bathroom or kitchen, at a competitive price with the Diamonte range of taps and mixers. The diamond cut effect of the Diamonte is superbly designed for an easy grip.



**Monobloc Basin Mixer**

Suitable for wash basin with one taphole. Combined pop-up waste-32mm.

S2311002 - Mono Basin Mixer  
 Chrome Finish



**Monobloc Sink Mixer**

Suitable for kitchen sinks with one taphole.

S.23130.02 - Mono Sink Mixer  
 Chrome Finish



**Bath and Shower Mixer**

Automatic safety diverter from shower to bath. Shower kit supplied includes chrome flexible hose, handset and wall bracket.

S2310002 - Bath Mixer and Shower Kit  
 Chrome Finish



**Bath and Basin Taps**

S2310502 - Bath Taps Chrome Finish - Pair  
 S2311502 - Basin Taps Chrome Finish - Pair



**Deck Sink Mixer**

Suitable for any conventional kitchen sink with 2-holes.

S2313502 - Diamonte Deck Sink Mixer  
 Chrome Finish



**Sink Pillar Taps**

S2314002 - Diamonte Sink Pillar Taps  
 Chrome Finish - Pair

FINISH  CHROME

Diamonte Range

## Nova Simplicity

Nova Simplicity Taps and Mixers are superbly designed. The easy-to-grip tap levers are 75mm long and can be easily operated by people with weak or arthritic hands. Hygienic chrome-plated finish.



### Bath and Basin Taps

P6349102 - Bath Pillar Taps Chrome Finish - Pair  
P6349101 - Basin Pillar Taps Chrome Finish - Pair



### Bath and Shower Mixer

P6349105 - Bath Mixer and Shower Kit  
Chrome Finish



### Sink Pillar Taps

P6349103 - Sink Pillar Taps Chrome Finish - Pair



### Deck Sink Mixer

Particularly suitable for ordinary kitchen sink tops which are fitted with standard 2-hole.

P6349104 - Deck Sink Mixer  
Chrome Finish

FINISH



CHROME

Nova Simplicity Range

## Novalever

Incorporates ceramic disc technology with simple quarter-turn action. W.R.C. approved. Designed with levers 125mm long, for ease of use.



### Bath and Basin Taps

P6300031 - Bath Taps Chrome Finish-Pair

P6300032 - Basin Taps Chrome Finish-Pair



### Bath and Shower Mixer

Automatic Safety diverter from shower to bath. Shower Kit includes flexible tube, hand shower and wall bracket.

P6300030 - Bath and Shower Mixer  
Chrome Finish

Novalever Range



### Sink Pillar Taps

P6300033 - Sink Pillar Taps Chrome Finish-Pair



### Deck Sink Mixer

Suitable for any conventional kitchen sink with a standard 2-hole. The nozzle swivels and projects into the sink 165mm.

P6300034 - Deck Sink Mixer  
Chrome Finish

FINISH



CHROME



**Novaturn**

A unique design with hand wheels featuring a raised lobe and thumb grip. This enables the tap to be turned with ease. Ceramic disc with 1/4 turn action.



**Bath and Basin Taps**

- P6300004 - Bath Taps Chrome Finish - Pair
- P6300005 - Bath Taps White Finish - Pair
- P6300007 - Basin Taps Chrome Finish - Pair
- P6300008 - Basin Taps White Finish - Pair



**Bath and Shower Mixer**

Automatic safety diverter from shower to bath. Shower kit includes flexible tube, hand shower and wall bracket. Connections-19mm.

- P6300001 - Bath Mixer  
Chrome Finish
- P6300002 - Bath Mixer  
White Finish



**Sink Pillar Taps**

- P6300013 - Sink Pillar Taps Chrome Finish - Pair

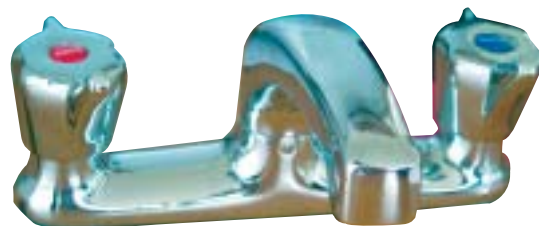

**Deck Sink Mixer**

Suitable for kitchen sink tops with standard two-hole. Swivel nozzle with 180mm projection.

- P6300014 - Sink Mixer Chrome Finish



**Monobloc Basin Mixer**

Suitable for wash basin with one taphole. Combined pop-up waste-32mm.

- P6300010 - Basin Mixer Chrome Finish
- P6300011 - Basin Mixer White Finish



**Monobloc Sink Mixer**

Suitable for kitchen sinks with one taphole. Swivel nozzle with 230mm projection.

- P6300015 - Sink Mixer  
Chrome Finish
- P6300016 - Sink Mixer  
White Finish



Novaturn Range



## Remote Control Taps

Panel type stopcocks with separate water outlets. The Novatum controls can be fitted through the fascia of a plinth so that the user does not have to reach across the basin to operate the taps. Pipe work between the stopcocks and the water outlets is not included.



P6300026 - Basin Taps Chrome Finish - Pair



P6300025 - Kitchen Taps Chrome Finish - Pair

## Simplicity Conversion Kit

With Phlexicare's conversion tap heads every tap can be a Simplicity tap, by simply changing the heads of the existing tap. A cost effective and ideal solution to helping with weak or arthritic hands.



Three easy steps to a new Simplicity tap.

- Turn off the water supply
- Remove existing tap head and valve.
- Replace with your new Simplicity conversion head and reconnect water.

P6349125 - Basin (1 Pair Tap Heads plus 2x 1/2" Conversion Valves)

P6349126 - Bath (1 Pair Tap Heads plus 2x 3/4" Conversion Valves)



## Marbles

This modern and distinctive 'Marbles' range demonstrates how taps can provide a sense of style and fashion to the bathroom or kitchen.

Colourful 'Marbles' allow for instant recognition of hot and cold water, making it particularly beneficial for the partially sighted. A simple 1/4 turn action incorporating ceramic disc technology also benefits all users. Available in a chrome finish.



### Bath and Basin Taps

P6349140 - Bath Taps Chrome Finish - pair  
 P6349141 - Basin Taps Chrome Finish - pair



### Sink Pillar Taps

P6349142 - Sink Taps Chrome Finish - pair



### Monobloc Bidet Mixer

P6349145 - Bidet Mixer with Pop up Waste  
 Chrome Finish



### Monobloc Basin Mixer

P6349144 - Basin Mixer with Pop up Waste  
 Chrome Finish



### Bath and Shower Mixer

P6349143 - Bath/shower Mixer with Kit. Chrome Finish

FINISH



CHROME

## Duet

### A REVOLUTION IN TAP DESIGN

This unique and stylish tap design ensures the Duet will enhance the decor of any bathroom. Available in chrome, white and gold finishes. Distinctive elegant spouts provide instant recognition of hot and cold water making it ideal for every situation and particularly beneficial for the partially sighted. Ideal in hotels for identifying the cold water spout or where a kettle jug needs filling.

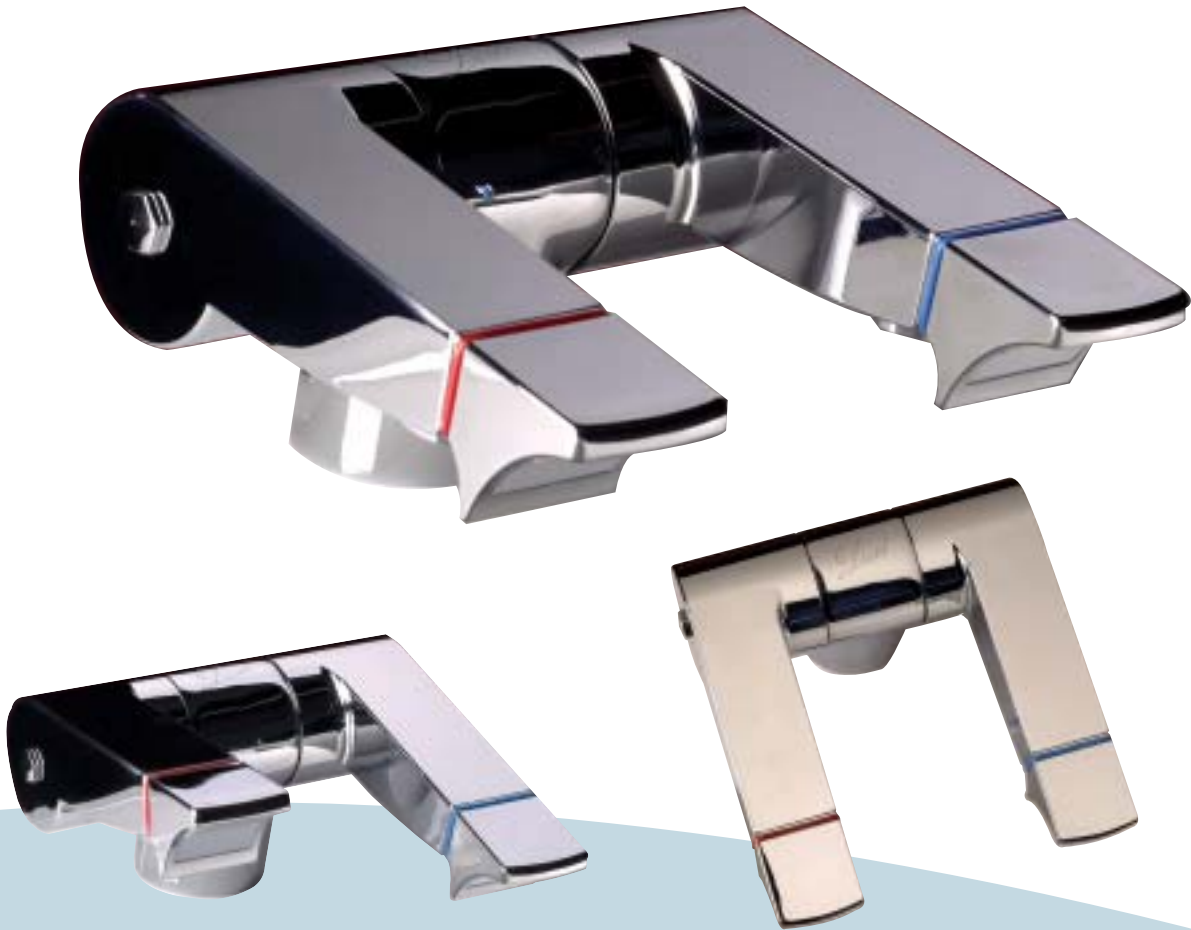

Duet Range

#### DUET TAPS

P6349130 - 'Duet' Tap Chrome Finish

P6349131 - 'Duet' Tap White Finish

P6349132 - 'Duet' Tap Gold Finish

#### UNIVERSAL

The Duet will fit all hand basins, kitchen sinks and baths. On two Taphole baths, simply blank off the hole nearest the wall and fit the Duet closest to the corner which is then ideal for easy reach.

#### ERGONOMICS

No awkward handles or levers to turn, just simply lift the easy action spout for controlled water and to turn off, just use the weight of your hand.

#### TECHNOLOGY

The special heat resistant spouts with aerator helps ensure safety for all users.

FINISHES



CHROME



GOLD



WHITE

**Pelican**

**Olympus**



**Monobloc Basin Mixer**

S2331073 - Basin Mixer with Pop-up Waste  
Chrome/Gold Finish



**Monobloc Bidet Mixer**

S2331075 - Bidet Mixer with Pop-up Waste  
Chrome/Gold Finish



**Bath/Shower Mixer**

S2331074 - Bath/Shower Mixer with Kit  
Chrome/Gold Finish



**Bath Filler**

S2332073 - Bath Filler Chrome/Gold Finish

**Pelican Range**

PELICAN QUARTER TURN CERAMIC DISC LUXURY BRASSWARE

FINISH



CHROME/GOLD



**Duo**

The Olympus Duo mixers are in a class by themselves. Made to the highest standards and designed to make life easier in any environment.



**Mono Basin Mixer Single Lever**  
S7004040 - Basin Mixer Single Lever  
with Pop-up Waste  
Chrome Finish



**Mono Bidet Mixer Single Lever**  
S7004041 - Bidet Mixer Single Lever  
with Pop-up Waste  
Chrome Finish

Duo Range



**Bath and Shower Mixer Single Lever**  
S7004042 - Bath/Shower Mixer Single Lever  
with Hose and Handset  
Chrome Finish





**N&C**

**PHLEXICARE**

# Sanitaryware & Kitchens

With over 30 years experience within the healthcare industry, N&C Phlexicare are proud to have been entrusted in providing solutions to problems encountered by the elderly and disabled

For the Specifier, Contractor and end user, the following pages will help demonstrate our commitment to quality and innovation across a full range of Showering, Bathing, Toileting, Kitchen and Access products.

## Windsor Power Bath (With Leg Raiser)

The Windsor powered bath comes complete with a built-in hydraulic seat lift, operated by a convenient hand control set. It is the deepest bath of its kind available and offers a range of options from child care seat to fully powered traverse seat with leg raiser.

### Convenient hand control

A simple and easy to use remote handset operates all functions of the Windsor bath.

Prices include delivery and commissioning

- 1500mm or 1700mm
- Left or Right Hand Option
- Manual or Power Traverse
- Optional Leg Raiser
- Child Seat
- 152 Kg Lift
- Extra Deep 440mm
- Battery Back-up
- 24v External Transformer
- Folding Arm Rests

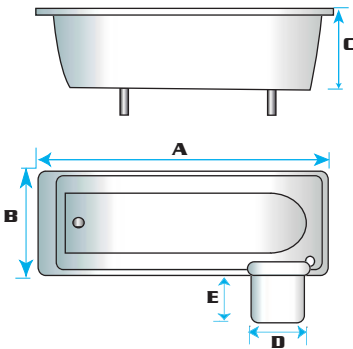

- A = 1700mm
- = 1500mm
- B = 745mm
- C = 440mm
- D = 415mm
- E = 600mm
- Seat to Floor = 340mm Series 1+2



Bathing

### WINDSOR SERIES 1 MANUAL TRAVERSE

Built-in 24 volt hydraulic seat lift with manual traverse. Battery back up. Folding arm rest. Plug chain and stay. Front panel in GRP. Hand control set.

- P6808528 - Windsor Series 1 Manual Traverse Right hand 1700mm
- P6808529 - Windsor Series 1 Manual Traverse Left hand 1700mm
- P6808530 - Windsor Series 1 Manual Traverse Right hand 1500mm
- P6808531 - Windsor Series 1 Manual Traverse Left hand 1500mm

### WINDSOR SERIES 2 POWER TRAVERSE

Built-in 24 volt hydraulic seat lift with power traverse. Battery back up. Folding arm rest. Plug chain and stay. Front panel in GRP. Hand control set.

- P6808532 - Windsor Series 2 Power Traverse Right hand 1700mm
- P6808533 - Windsor Series 2 Power Traverse Left hand 1700mm
- P6808534 - Windsor Series 2 Power Traverse Right hand 1500mm
- P6808535 - Windsor Series 2 Power Traverse Left hand 1500mm

### WINDSOR SERIES 3 POWER TRAVERSE WITH LEG RAISER

Built-in 24 volt hydraulic seat lift with power traverse. Powered leg raiser. Battery back up. Folding arm rest. Plug chain and stay. Front panel in GRP. Hand control set.

- P6808536 - Windsor Series 3 Power Traverse with leg raiser Right hand 1700mm
- P6808537 - Windsor Series 3 Power Traverse with leg raiser Left hand 1700mm
- P6808538 - Windsor Series 3 Power Traverse with leg raiser Right hand 1500mm
- P6808539 - Windsor Series 3 Power Traverse with leg raiser Left hand 1500mm

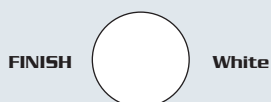
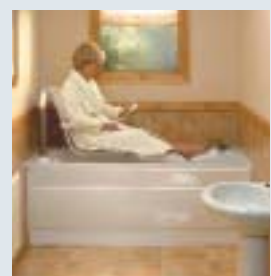
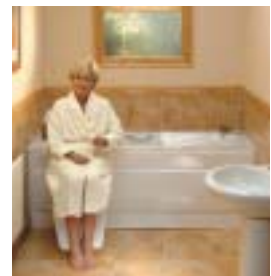

Above product numbers for white.  
Choice of colours available.

## Windsor Power Bath (Optional Extras)

The Windsor Power Bath has many optional extras including a leg raiser and child seat, making this bath versatile, safe and stylish.

### EASY ACCESS TO THE SEAT

The strong GRP seat has a slip-resistant base and folding arm rests to facilitate easy access. Also available is the child care seat which can be easily replaced at a later date for an adult seat if required.



#### Optional extras

- P6808540 - Leg raiser (Series 1)
- P6808541 - Child Seat Conversion
- P6808542 - Nursing Arms
- P6808543 - Safety Strap
- P6808544 - Mahogany Side Panel
- P6808545 - Mahogany End Panel
- P6808546 - Pine Side Panel
- P6808547 - Pine End Panel
- P6808548 - GRP Side Panel
- P6808549 - GRP End Panel

## Claremont Bath

This comfortable heavy-duty bath is equally at home in domestic housing, nursing homes or hotels. An attractive cut away front assists those with restricted leg movement to enter and exit the bath. It is supplied with a very effective slip resistant area for showering and a generous shelf area for accessories such as soap and sponge.

Suitable for conventional or peninsular installation and supplied as standard with centre end tap holes.

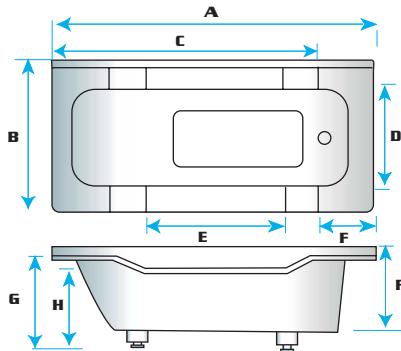

- A = 1700mm
- B = 780mm
- C = 1465mm
- D = 545mm
- E = 750mm
- F = 270mm
- G = 500mm
- H = 420mm



P6806501 - Claremont Bath 1700mm Colour White Taphole 2

#### Accessories

- P6806201 - Front Panel, White
- P6806301 - End Panel/Angle Strip, White
- Waste Fittings
- P6840801 - Lever Action pop up waste and overflow, Chrome

For Olympus Taps and Mixers See Page 53

## Shallow Bath

The Shallow Bath is designed so that the distance from base to rim is minimised, aiding those with restricted leg movement. The Shallow Bath is made from traditional deep-enamelled pressed steel.

- Twin tubular hand grips
- Slip resistant surface
- Bath height adjustment floor to rim 450-480mm

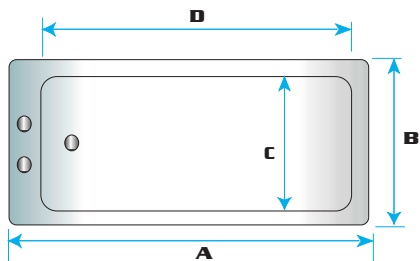

**A = 1690mm**  
**B = 700mm**  
**C = 565mm**  
**D = 1486mm**



**P6800251 - Shallow Bath Size 1700mm with Twin Hand Grips, White**

**Accessories**

- S2011002 - Front Panel, White Hardboard**
- S2011012 - End Panel, White Hardboard**
- S2011501 - Angle Strip, Chrome Finish**

## Duet Walk in Bath

The Duet walk-in bath is suitable for both bathing and showering.

- User can recline full length
- Low entry door
- Easy to use door opening system
- Slip-resistant shower area.
- Supplied with front panel

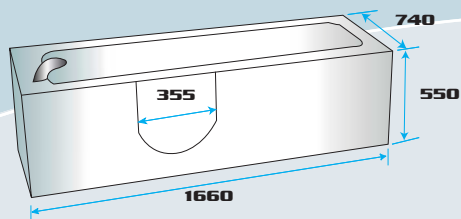

**Bathing area - 1490 x 580 x 400mm**  
**Door opening - 350 x 330mm height**  
**Step - 115 - 140mm**

**P6808560 - Duet Bath 1660 x 740mm White**  
**P6808561 - Duet Bath 1660 x 740mm White with Hydrotherapy Unit**

**P6808562 - Duet End Panels Right Hand White**  
**P6808563 - Duet End Panels Left Hand White**

For Olympus Taps and Mixers See Page 53



## Luxor Luxury Bath

Re-discover the pleasures of bathing. The stylish Luxor bath allows the user to walk in and out and to gently lower themselves into the bath on the power driven seat.

The Luxor has been carefully designed to enable relaxation and enjoyment of the luxury of a deep filled bath. Available with the optional Hydrotherapy system to relax and soothe those tired limbs.

- Can be filled deeper than most standard baths.
- Seat descends to the bottom of the bath.
- Weight limit for motorised seat 130 kg.
- Easy to use door opening system.
- Safety of a TMV3 thermostatic valve to control water temperature.
- Twin wastes with chains and plugs allows bath to empty faster. The plugs and chains are within easy reach of the user whilst seated.



Touch control buttons for total water control. Automatically fills to pre-determined level.



Bathing

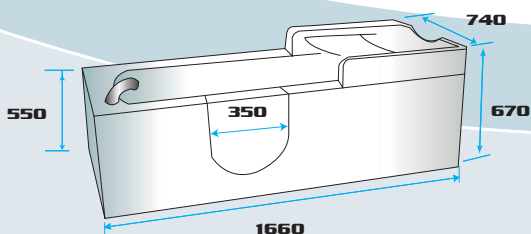

Bathing area - 1490 x 580 x 400mm  
 Door opening - 350mm width 330mm height  
 Size of seat belt - 580mm width 300mm deep  
 Step up from floor to bottom of door - 115-140mm

- P6808565 - Luxor Bath, Touch Control 1660 x 740mm, White
- P6808566 - Luxor Bath Hydrotherapy, Touch Control 1660 x 740mm, White
- P6808562 - Luxor End Panel Right Hand, White
- P6808563 - Luxor End Panel Left Hand, White

Almost any colour available to special order



## Caleche Walk-in Bath

The Caleche Walk-in Bath provides a totally relaxing bathing experience. The specially moulded tub shape relaxes the user and adds an element of safety. Having twice the depth of a conventional bath, the Caleche allows you to have a deep soak in a comfortable sitting position.

- Straight and corner bath
- Left or right hand door option
- Hydrotherapy spa system available
- Optional seat heights
- Choice of colours
- Internal depth 795mm
- Optional grab rail
- Shower canopy

### CALECHE WALK-IN BATH CORNER

- P6801020 - Caleche Walk-in Bath Tap Positions Left hand, White
- P6801021 - Caleche Walk-in Bath Tap Positions Right hand, White

### CALECHE WALK-IN BATH STANDARD

- P6801022 - Caleche Walk-in Bath Tap Positions Left hand, White
- P6801023 - Caleche Walk-in Bath Tap Positions Right hand, White

### OPTIONAL EXTRAS

- P6801025 - Corner Shower Canopy
- P6801026 - Standard Shower Canopy
- P6801027 - Seat Raiser 75mm
- P6801028 - Seat Raiser 125mm

### AIR SPA

- P6801030 - 12 Jet Self Colour
- P6801031 - 12 Jet Chrome
- P6801032 - 16 Jet Self Colour
- P6801033 - 16 Jet Chrome
- P6801034 - Additional Straight Side Panel

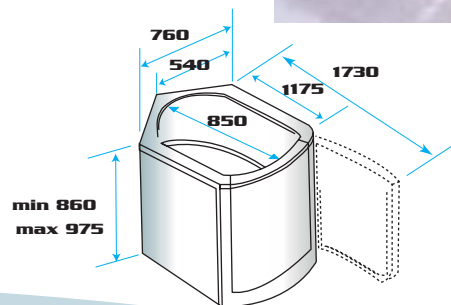
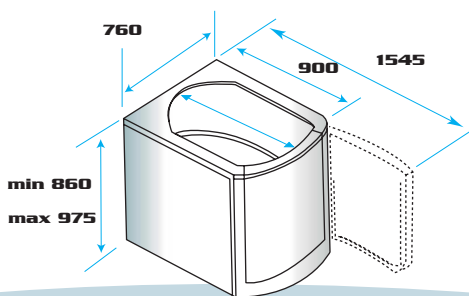

Seat Height 280mm  
Internal Depth 795mm  
Step Height 165mm

## Classic Walk-in Bath

Our Classic Walk-in Bath utilizes a simple push button door opener and cushioned seat.

- Choice of seat height adjustments between 380-440mm
- Twin wastes, plugs and chains to empty the bath faster.
- Supplied with side and end panels

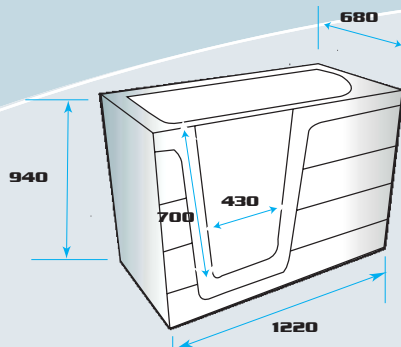

Opening size of door  
430mm wide 700mm high

Seat cushion size  
580mm wide 230mm deep  
Weight limit 130 kg

### CLASSIC BATH

- P6808570 - Classic Bath 1220x680mm, White

### CLASSIC EXTENSION BOX

- P6808571 - Classic Extension Box three sided 800 x 680 x 590, White  
No need to re-tile when replacing an old bath



For Olympus Taps and Mixers See Page 53

## Trojan Bath (Height-adjustable)

This height adjustable bath has particular benefits for carers. At the touch of a button the bath can be raised or lowered between 650mm and 950mm from the floor, which could help prevent back injury to the carer. An optional hinged shower stretcher provides a comfortable surface which can be raised to a suitable working height. There is also clearance under the bath to allow for the use of a variety of portable hoists.

- Sizes: 1600mm or 1800mm
- Raised or lowered between 650mm and 950mm
- Supplied with bath/shower mixer
- Optional hinged shower stretcher



Trojan Bath 1800mm

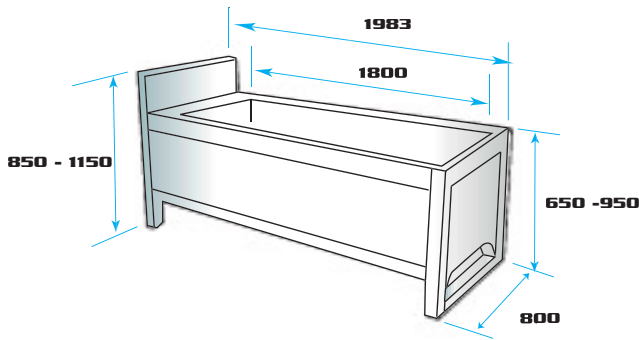

Trojan Bath 1600mm

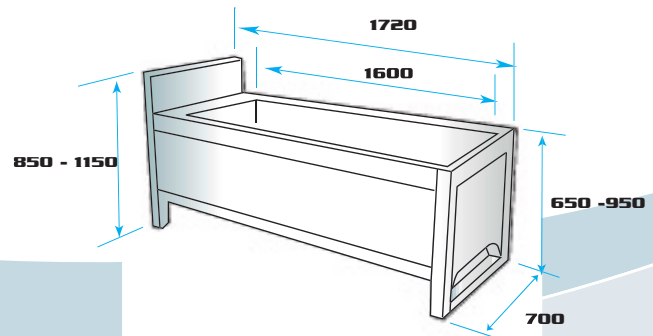

### TROJAN BATH

- P6808590 • Trojan Bath 1720 x 700mm  
 P6808591 • Trojan Bath 1930 x 800mm

### TROJAN BATH WITH SHOWER STRETCHER

- P6808592 • Trojan Bath with Shower Stretcher Right hand 1720 x 700mm  
 P6808593 • Trojan Bath with Shower Stretcher Left hand 1720 x 700mm  
 P6808594 • Trojan Bath with Shower Stretcher Right hand 1930 x 800mm  
 P6808595 • Trojan Bath with Shower Stretcher Left hand 1930 x 800mm

FINISH

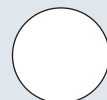

White

Bathing

## Trapeze Ceiling Lift



**P6802201** - A simple, cost-effective way to provide assistance for the more able user. A universal fitting kit allows positioning over a bath, chair or bed. It comprises of a strong trapeze-style pull handle and chain adjustable up to 1750mm length.

## Wall Mounted Trapeze Pull



**P6804001** - A triangulated grab handle centres and stabilises the load automatically. The strong nylon chain is nevertheless lightweight and easy to operate. The lifting arm is secured to the wall and can be unlocked and swung away sideways to save space when not in use. Useful over bath, chair or bed.

**Dimensions:** Mounting plate width 100mm  
 Mounting plate height 250mm  
 Arm projection from wall 770mm

## Relaxa Bath Seat



**P6802651** - This revolutionary seat design allows the width to be adjusted to suit many types and sizes of baths. The five-bar seat platform is textured to be slip-resistant when wet. The support bars are plastic coated to prevent marking the bath.

**Dimensions:** Depth of seat from bath roll 150mm  
 Width adjustment 500-650mm  
 Depth 320mm

## Swedish Bath Seat



**P6803001** - Strength without compromise. Chrome-plated steel forms the sturdy frame while a plastic-coated mesh provides superb seat comfort and back support. The solid arms and side-bearing beams are rubber tipped to prevent bath scuffing.

**Dimensions:** Depth of Seat from bath roll 200mm  
 Seat width 480mm

## Lopital Bath Board



**P6800711** - Made from the same ergonomic plastic material as the matching Lopital Bath Seat, it incorporates special fixing points which can mount the board to the bath sides. Suitable for persons weighing up to 150kg.

**Dimensions:** Adjustable width 640mm to 740mm.  
 Depth of Seat 300mm.

## Athina Cubicle

The Athina four sided cubicle is purpose built with strength and safety in mind. The unique Uni-Phlex two way door opening system can cope with heavy use and allows the doors to open both inwards and outwards. Athina Cubicles come in either white, silver or gold frames and in soft white, clear or frosted panels.



Athina White with clear panels



Athina Silver with frosted panels



Athina Gold with frosted panels

## Athina Half Height Doors

The standard Athina shower cubicle has a tough white frame, white unbreakable polypropylene panels and comprises:

- 1 Full height back panel white
- 2 Full height side panels white
- 1 Pair of half height doors white, clear or frosted
- 1 Shower tray white
- 1 Shower curtain

## Athina Full Height Doors

The standard Athina shower cubicle has a tough white frame, clear or frosted unbreakable polycarbonate panels and comprises:

- 1 Full height back panel white
- 2 Full height side panels white
- 1 Pair of full height doors clear or frosted
- 1 Shower tray white



Athina White with Soft White Panels

Showering

## Athina White Front Entry Cubicle with Half Height Doors

- P6821300 - Tray size 800x800, Waste Position Centre Back
- P6821301 - Tray size 900x700, Waste Position Centre Back
- P6821302 - Tray size 900x900, Waste Position Centre Back
- P6821303 - Tray size 1000x900, Waste Position Centre Back
- P6821304 - Tray size 1000x1000, Waste Position Centre Back
- P6821307 - Tray size 1300x720, Waste Position L/H Rear
- P6821308 - Tray size 1300x720, Waste Position R/H Rear
- P6821309 - Tray size 1300x840, Waste Position L/H Rear
- P6821310 - Tray size 1300x840, Waste Position R/H Rear

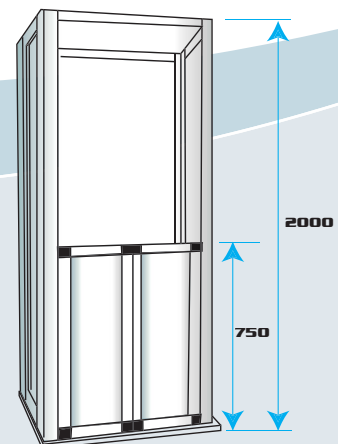

Complete with shower tray, curtain and hooks

For Showers See Page 93-95



**Athina Clear Front Entry Cubicle with Full Height Doors**

- P6821320 · Tray size 800x800, Waste Position Centre Back
- P6821321 · Tray size 900x700, Waste Position Centre Back
- P6821322 · Tray size 900x900, Waste Position Centre Back
- P6821323 · Tray size 1000x900, Waste Position Centre Back
- P6821324 · Tray size 1000x1000, Waste Position Centre Back
- P6821327 · Tray size 1300x720, Waste Position L/H Rear
- P6821328 · Tray size 1300x720, Waste Position R/H Rear
- P6821329 · Tray size 1300x840, Waste Position L/H Rear
- P6821330 · Tray size 1300x840, Waste Position R/H Rear

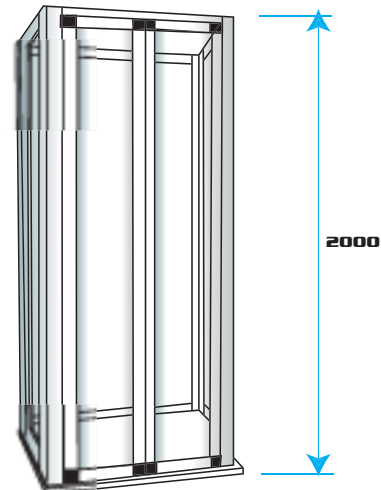

Complete with shower tray

**Athina Frosted Front Entry Cubicle with Full Height Doors**

- P6821340 · Tray size 800x800, Waste Position Centre Back
- P6821341 · Tray size 900x700, Waste Position Centre Back
- P6821342 · Tray size 900x900, Waste Position Centre Back
- P6821343 · Tray size 1000x900, Waste Position Centre Back
- P6821344 · Tray size 1000x1000, Waste Position Centre Back
- P6821347 · Tray size 1300x720, Waste Position L/H Rear
- P6821348 · Tray size 1300x720, Waste Position R/H Rear
- P6821349 · Tray size 1300x840, Waste Position L/H Rear
- P6821350 · Tray size 1300x840, Waste Position R/H Rear

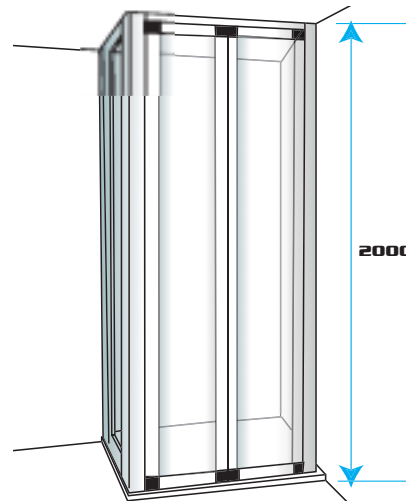

Complete with shower tray

Showering



Athina Half Height Doors



Athina Clear



Athina Frosted

For Showers Seats See Page 96-99



## Delphi Corner Enclosure Half Height Doors

The Delphi range of corner enclosures are ideal for installations which have tiled walls. This is a cost-effective alternative to the Athina cubicle.

Delphi enclosures come with either white, silver or gold frames and in soft white, clear or frosted panels.

The standard Delphi corner enclosure has a tough white frame, white unbreakable polypropylene panels and comprises

- 1 Half height side panel white
- 1 Pair of half height doors white
- 1 Shower Tray white
- 1 Pair Shower curtains

Half height doors and panels also available in clear or frosted polycarbonate



Delphi White with Soft White Panels

## Delphi Corner Enclosure Full Height Doors

The standard Delphi corner enclosure has a tough white frame, clear and frosted unbreakable polycarbonate panels and comprises:

- 1 Full height side panel clear or frosted
- 1 Shower Tray white
- 1 Pair of full height doors clear or frosted



Delphi Silver with Frosted Panels



Delphi Gold with Frosted Panels



Delphi White with Clear Panels

For Showers See Page 93-95

## Delphi White Corner Front Entry Enclosure with Half Height Doors

- P6821000 - Tray size 800x800, Waste Position Centre Back
- P6821001 - Tray size 900x700, Waste Position Centre Back
- P6821002 - Tray size 900x900, Waste Position Centre Back
- P6821003 - Tray size 1000x900, Waste Position Centre Back
- P6821004 - Tray size 1000x1000, Waste Position Centre Back
- P6821007 - Tray size 1300x720, Waste Position L/H Rear
- P6821008 - Tray size 1300x720, Waste Position R/H Rear
- P6821009 - Tray size 1300x840, Waste Position L/H Rear
- P6821010 - Tray size 1300x840, Waste Position R/H Rear

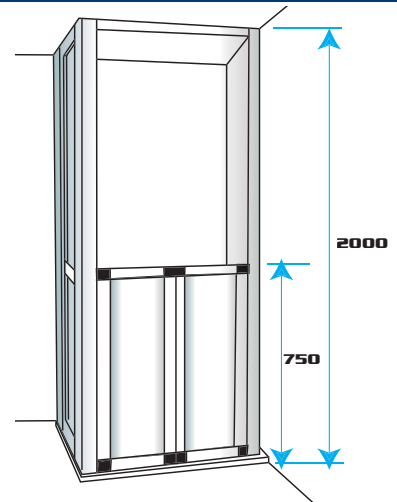

Complete with shower tray, curtain and hooks

## Delphi Clear Corner Front Entry Enclosure with Full Height Doors

- P6821020 - Tray size 800x800, Waste Position Centre Back
- P6821021 - Tray size 900x700, Waste Position Centre Back
- P6821022 - Tray size 900x900, Waste Position Centre Back
- P6821023 - Tray size 1000x900, Waste Position Centre Back
- P6821024 - Tray size 1000x1000, Waste Position Centre Back
- P6821027 - Tray size 1300x720, Waste Position L/H Rear
- P6821028 - Tray size 1300x720, Waste Position R/H Rear
- P6821029 - Tray size 1300x840, Waste Position L/H Rear
- P6821030 - Tray size 1300x840, Waste Position R/H Rear

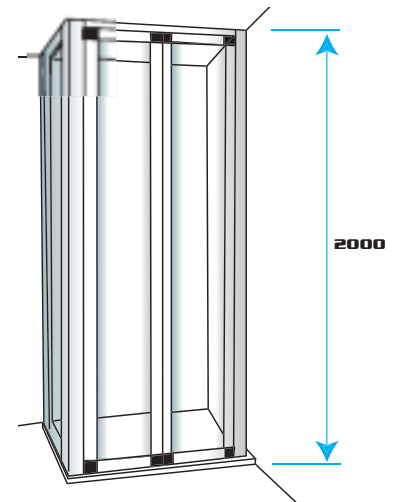

Complete with shower tray

## Delphi Frosted Corner Front Entry Enclosure with Full Height Doors

- P6821035 - Tray size 800x800, Waste Position Centre Back
- P6821036 - Tray size 900x700, Waste Position Centre Back
- P6821037 - Tray size 900x900, Waste Position Centre Back
- P6821038 - Tray size 1000x900, Waste Position Centre Back
- P6821039 - Tray size 1000x1000, Waste Position Centre Back
- P6821042 - Tray size 1300x720, Waste Position L/H Rear
- P6821043 - Tray size 1300x720, Waste Position R/H Rear
- P6821044 - Tray size 1300x840, Waste Position L/H Rear
- P6821045 - Tray size 1300x840, Waste Position R/H Rear

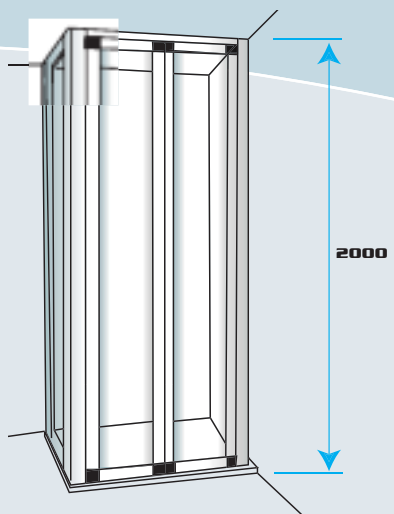

Complete with shower tray

For Shower Seats See Page 96-99

**Phlexicare Shower Trays (Now with Anti-microbial Protection)**

Phlexicare shower trays are strongly fabricated in white G.R.P. with the under side thoroughly reinforced to help prevent distortion and are equipped with a very effective slip-resistant surface. The low edge profile, which, with its reduced tray lip helps to provide easy access even when installed directly on the floor. The shower tray can also be set into the floor to the depth of the front lip, which is equivalent to the thickness of one standard floorboard. This leaves only the small (10mm) bevel edge to overcome.

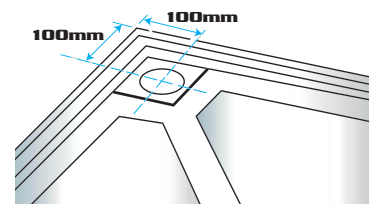
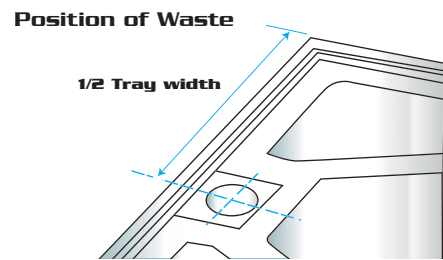
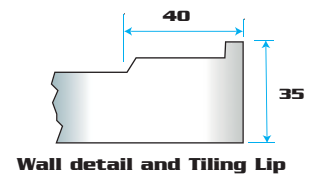
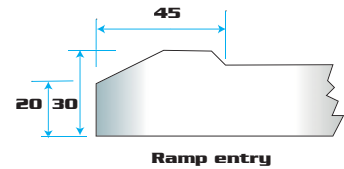

Where it is not possible to let the shower tray into the floor, a loose ramp is available which can be cut, mitred and attached to the tray on site.  
**P6821410 - 2.5mtr loose shower ramp**

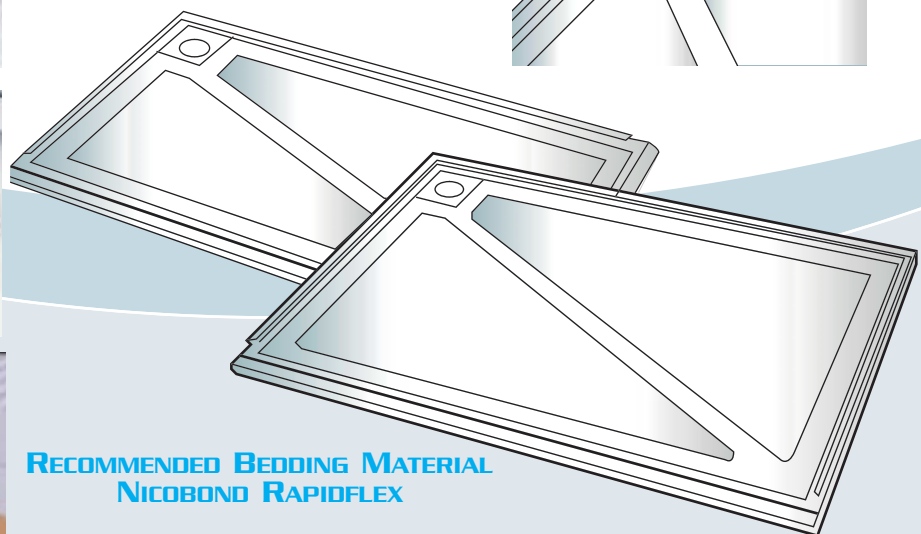

**RECOMMENDED BEDDING MATERIAL  
 NICOBOND RAPIDFLEX**

For Showers See Page 93-95

Showering

**Shower Trays Front Entry**

Phlexicare

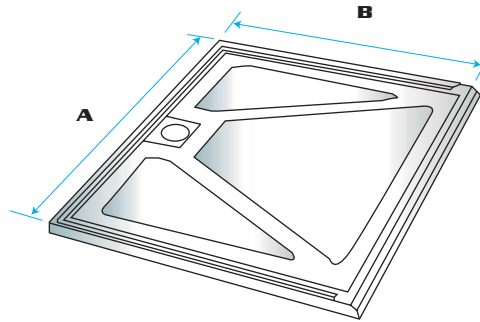

A	B
800	800
900	700
900	900
1000	900
1000	1000

- P6821420 - Showering Area 760wide x 730deep, Waste Position Centre back
- P6821424 - Showering Area 860wide x 630deep, Waste Position Centre back
- P6821421 - Showering Area 860wide x 830deep, Waste Position Centre back
- P6821422 - Showering Area 960wide x 830deep, Waste Position Centre back
- P6821423 - Showering Area 960wide x 930deep, Waste Position Centre back

- Door Style available A
- Door Style available A
- Door Style available A
- Door Style available A
- Door Style available A

Showering

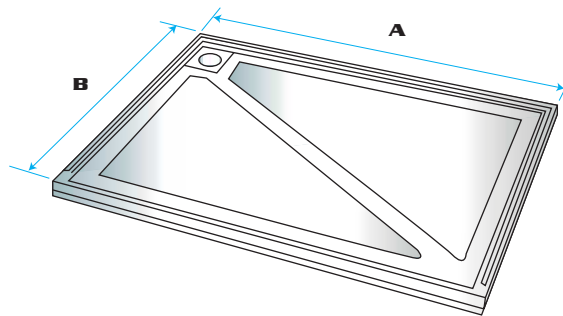

A	B
1200	720
1200	720
1200	840
1200	840
1300	720
1300	720
1300	840
1300	840
1500	720
1500	720
1500	840
1500	840
1700	720
1700	720
1700	840
1700	840

- P6821391 - Showering Area 1160 wide x 650 deep, Waste Position L/H Rear
- P6821392 - Showering Area 1160 wide x 650 deep, Waste Position R/H Rear
- P6820535 - Showering Area 1160 wide x 770 deep, Waste Position L/H Rear
- P6820536 - Showering Area 1160 wide x 770 deep, Waste Position R/H Rear
- P6821425 - Showering Area 1260 wide x 650 deep, Waste Position L/H Rear
- P6821426 - Showering Area 1260 wide x 650 deep, Waste Position R/H Rear
- P6821427 - Showering Area 1260 wide x 770 deep, Waste Position L/H Rear
- P6821428 - Showering Area 1260 wide x 770 deep, Waste Position R/H Rear
- P6820537 - Showering Area 1460 wide x 650 deep, Waste Position L/H Rear
- P6820538 - Showering Area 1460 wide x 650 deep, Waste Position R/H Rear
- P6820539 - Showering Area 1460 wide x 770 deep, Waste Position L/H Rear
- P6820540 - Showering Area 1460 wide x 770 deep, Waste Position R/H Rear
- P6821415 - Showering Area 1660 wide x 650 deep, Waste Position L/H Rear
- P6821416 - Showering Area 1660 wide x 650 deep, Waste Position R/H Rear
- P6821418 - Showering Area 1660 wide x 770 deep, Waste Position L/H Rear
- P6821419 - Showering Area 1660 wide x 770 deep, Waste Position R/H Rear

- Door Style available A,B
- Door Style available A,B
- Door Style available A,B
- Door Style available A,B
- Door Style available A,B
- Door Style available A,B
- Door Style available A,B
- Door Style available A,B
- Door Style available B
- Door Style available B
- Door Style available B
- Door Style available B
- Door Style available B,D
- Door Style available B,D
- Door Style available B,D
- Door Style available B,D

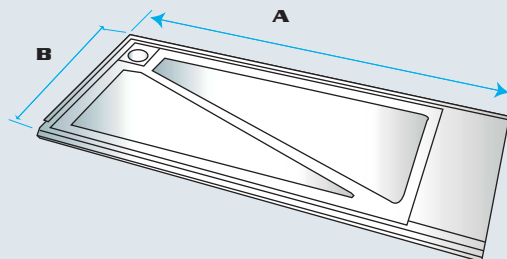

A	B
1700*	720
1700*	720
1700*	840
1700*	840

\* These trays can be cut to size on site to a minimum of 1500mm or ordered to precise length from our factory.

- P6821437 - Showering Area 1660 - 1460 wide x 650 deep, Waste Position L/H Rear
- P6821438 - Showering Area 1660 - 1460 wide x 650 deep, Waste Position R/H Rear
- P6821439 - Showering Area 1660 - 1460 wide x 770 deep, Waste Position L/H Rear
- P6821440 - Showering Area 1660 - 1460 wide x 770 deep, Waste Position R/H Rear

- Door Style available B,D
- Door Style available B,D
- Door Style available B,D
- Door Style available B,D

For Shower Seats See Page 96-99



## Shower Trays Front Entry

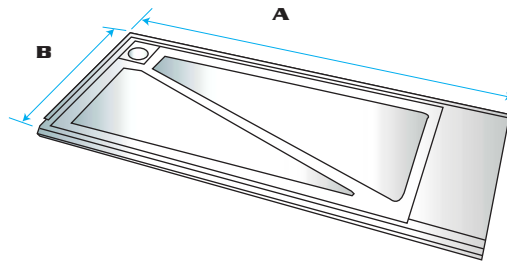

A	B
1800*	720
1800*	720
1800*	840
1800*	840

\* These trays can be cut to size on site to a minimum of 1700mm or ordered to precise length from our factory.

- P6820542 - Showering Area 1760 - 1660 wide x 650 deep, Waste Position L/H Rear Door Style available B,D  
 P6820543 - Showering Area 1760 - 1660 wide x 650 deep, Waste Position R/H Rear Door Style available B,D  
 P6820544 - Showering Area 1760 - 1660 wide x 770 deep, Waste Position L/H Rear Door Style available B,D  
 P6820545 - Showering Area 1760 - 1660 wide x 770 deep, Waste Position R/H Rear Door Style available B,D

## Shower Trays Corner Entry

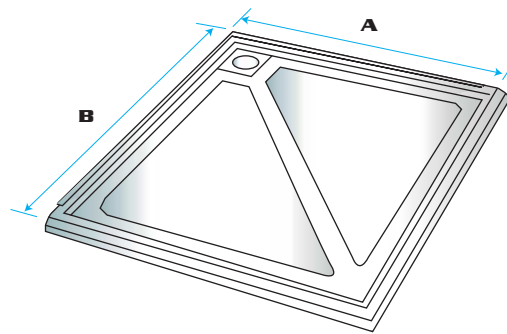

A	B
800	800
900	900
1000	1000
1200	1200

- P6820541 - Showering Area 730 wide x 730 deep, Waste Position Rear Corner Door Style available E  
 P6821430 - Showering Area 830 wide x 830 deep, Waste Position Rear Corner Door Style available E,G,J  
 P6821414 - Showering Area 930 wide x 930 deep, Waste Position Rear Corner Door Style available G,J  
 P6821431 - Showering Area 1130 wide x 1130 deep, Waste Position Rear Corner Door Style available G,J

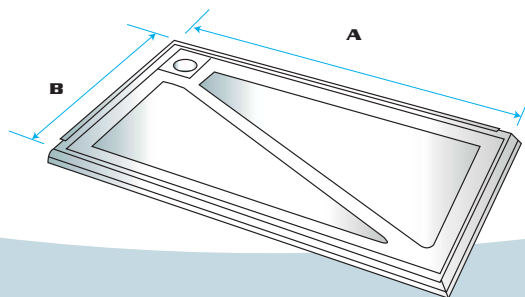

A	B
1200	720
1200	720
1200	840
1200	840
1300	720
1300	720
1300	840
1300	840

- P6821395 - Showering Area 1130 wide x 650 deep, Waste Position L/H Rear Door Style available F,H,K  
 P6821396 - Showering Area 1130 wide x 650 deep, Waste Position R/H Rear Door Style available F,H,K  
 P6820546 - Showering Area 1130 wide x 770 deep, Waste Position L/H Rear Door Style available F,H,K  
 P6820547 - Showering Area 1130 wide x 770 deep, Waste Position R/H Rear Door Style available F,H,K  
 P6821433 - Showering Area 1230 wide x 650 deep, Waste Position L/H Rear Door Style available F,H,K  
 P6821434 - Showering Area 1230 wide x 650 deep, Waste Position R/H Rear Door Style available F,H,K  
 P6821435 - Showering Area 1230 wide x 770 deep, Waste Position L/H Rear Door Style available F,H,K  
 P6821436 - Showering Area 1230 wide x 770 deep, Waste Position R/H Rear Door Style available F,H,K

Showering

For Showers See Page 93-95



**Phlexicare Shower Doors**



Phlexicare shower doors incorporate the new Uni-Phlex two way door opening system, making them easy to install and capable of withstanding heavy use. All standard half-height doors are manufactured from sturdy aluminium profiles in hard-wearing white coating, with unbreakable soft white 4.5mm polypropylene panels. Doors are supplied with a wall fixing profile which has built-in adjustment for out-of-true walls. All doors are available to order in clear and frosted finish.

**Style A Front Entry Single Doors**

- P6821460 - To Fit Tray Size 800 x 800
- P6821461 - To Fit Tray Size 900 x 700
- P6821461 - To Fit Tray Size 900 x 900
- P6821462 - To Fit Tray Size 1000 x 900
- P6821462 - To Fit Tray Size 1000 x 1000
- P6821381 - To Fit Tray Size 1200 x 720
- P6821381 - To Fit Tray Size 1200 x 840
- P6821465 - To Fit Tray Size 1300 x 720
- P6821465 - To Fit Tray Size 1300 x 840



P6821578 - Door Retaining Bar

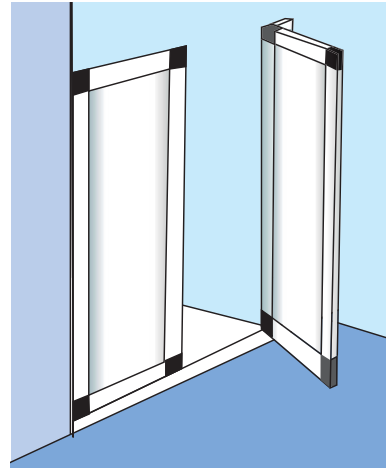

**Style B Front Entry Bi-Fold Doors**

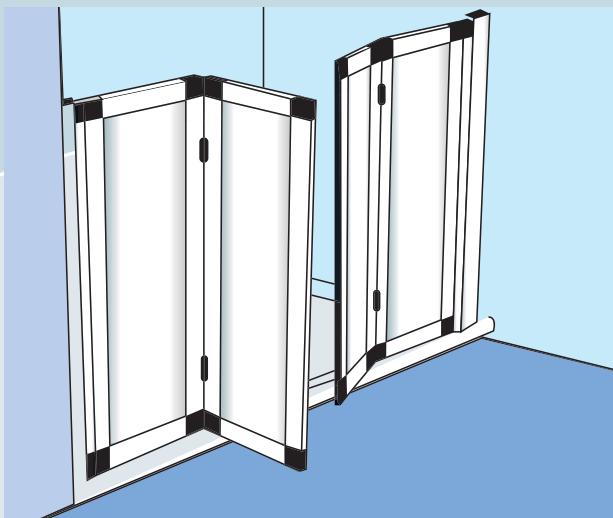

- P6821383 - To Fit Tray Size 1200 x 720
- P6821383 - To Fit Tray Size 1200 x 840
- P6821466 - To Fit Tray Size 1300 x 720
- P6821466 - To Fit Tray Size 1300 x 840
- P6821481 - To Fit Tray Size 1500 x 720
- P6821481 - To Fit Tray Size 1500 x 840
- P6821474 - To Fit Tray Size 1700 x 720
- P6821474 - To Fit Tray Size 1700 x 840

- Made to Order - To Fit Tray Size 1700 x 720 Cut to Size
- Made to Order - To Fit Tray Size 1700 x 840 Cut to Size
- Made to Order - To Fit Tray Size 1800 x 720 Cut to Size
- Made to Order - To Fit Tray Size 1800 x 840 Cut to Size

For Shower Seats See Page 96-99

**Style D Wet and Dry Door Set**

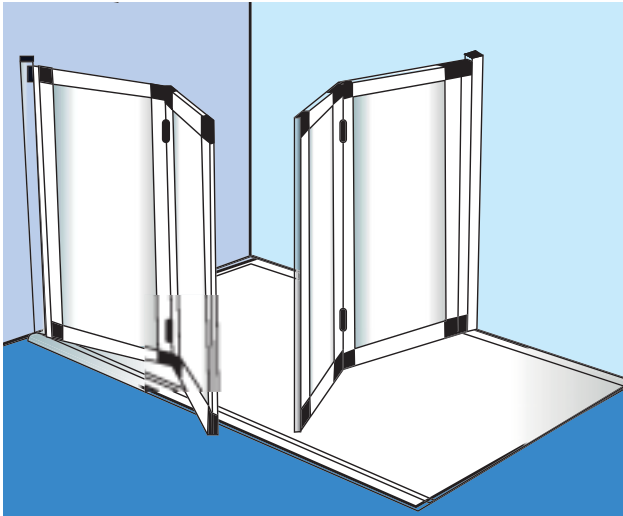

**Door Size 1100 x 720**

P6821405 - To Fit Tray Size 1700 x 720 L/H

P6821406 - To Fit Tray Size 1700 x 720 R/H

**Door Size 1100 x 840**

P6821407 - To Fit Tray Size 1700 x 840 L/H

P6821408 - To Fit Tray Size 1700 x 840 R/H

**Door Size 1100 x 720**

P6821405 - To Fit Tray Size 1800 x 720 L/H

P6821406 - To Fit Tray Size 1800 x 720 R/H

**Door Size 1100 x 840**

P6821407 - To Fit Tray Size 1800 x 840 L/H

P6821408 - To Fit Tray Size 1800 x 840 R/H

**Style E Corner Entry Single Doors**

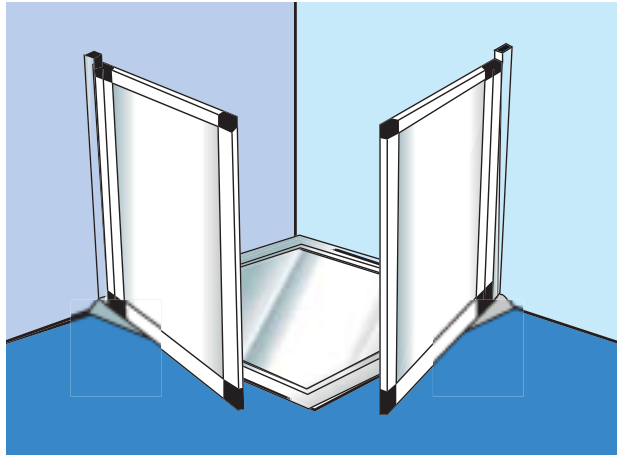

P6821469 - To Fit Tray Size 800 x 800

P6821467 - To Fit Tray Size 900 x 900

**Style F Corner Entry Single/Bi-Fold Door**

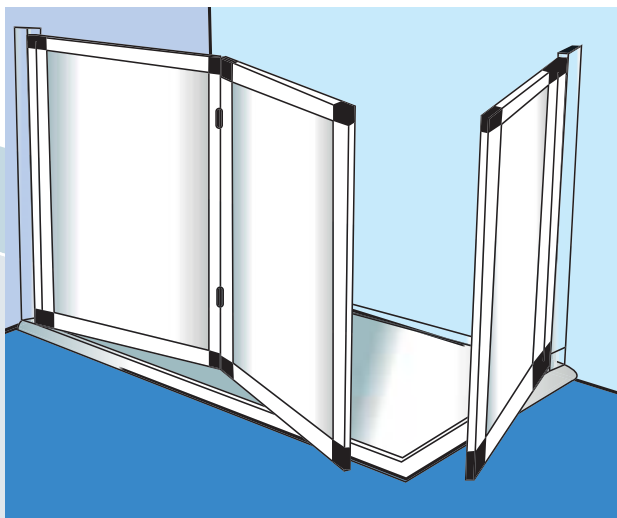

P6821385 - To Fit Tray Size 1200 x 720 L/H

P6821386 - To Fit Tray Size 1200 x 720 R/H

P6821398 - To Fit Tray Size 1200 x 840 L/H

P6821399 - To Fit Tray Size 1200 x 840 R/H

P6821470 - To Fit Tray Size 1300 x 720 L/H

P6821471 - To Fit Tray Size 1300 x 720 R/H

P6821472 - To Fit Tray Size 1300 x 840 L/H

P6821473 - To Fit Tray Size 1300 x 840 R/H

Showering

For Showers See Page 93-95

**Style G Corner Entry Doors with Fixed Panels**

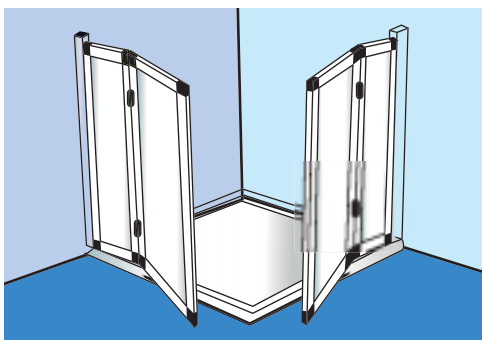

- P6821457 - To Fit Tray Size 900 x 900, 250mm Fixed Panel
- P6821458 - To Fit Tray Size 1000 x 1000, 350mm Fixed Panel
- P6821459 - To Fit Tray Size 1200 x 1200, 450mm Fixed Panel

**Style H Corner Entry Doors with One Fixed Panel**

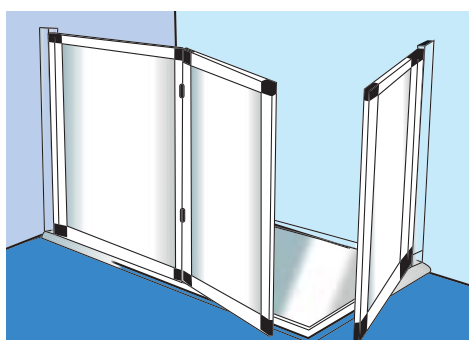

- P6821520 - To Fit Tray Size 1200 x 720 L/H
- P6821521 - To Fit Tray Size 1200 x 720 R/H
- P6821522 - To Fit Tray Size 1200 x 840 L/H
- P6821523 - To Fit Tray Size 1200 x 840 R/H
- P6821524 - To Fit Tray Size 1300 x 720 L/H
- P6821525 - To Fit Tray Size 1300 x 720 R/H
- P6821526 - To Fit Tray Size 1300 x 840 L/H
- P6821527 - To Fit Tray Size 1300 x 840 R/H

P6821478 - For Extra Stability use Stirling Rail

**Style J Corner Entry Bi Fold Doors**

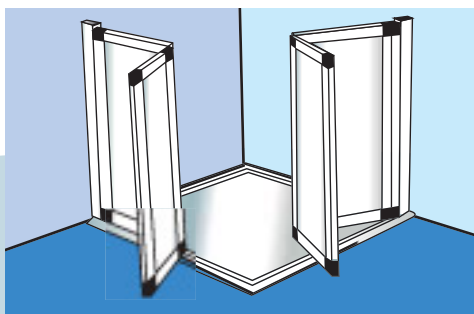

- P6821528 - To Fit Tray Size 900 x 900
- P6821529 - To Fit Tray Size 1000 x 1000
- P6821530 - To Fit Tray Size 1200 x 1200

**Style K Corner Entry Bi Fold/Tri-Fold Doors**

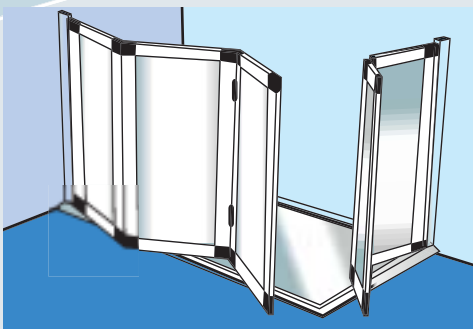

- P6821531 - To Fit Tray Size 1200 x 720 L/H
- P6821532 - To Fit Tray Size 1200 x 720 R/H
- P6821533 - To Fit Tray Size 1200 x 840 L/H
- P6821534 - To Fit Tray Size 1200 x 840 R/H
- P6821505 - To Fit Tray Size 1300 x 720 L/H
- P6821506 - To Fit Tray Size 1300 x 720 R/H
- P6821535 - To Fit Tray Size 1300 x 840 L/H
- P6821536 - To Fit Tray Size 1300 x 840 R/H

For Shower Seats See Page 96-99

## Flush Fit Level Entry

Introducing a unique and practical combination of Flush Fit shower trays, doors and colour co-ordinated slip resistant mats.

To suit your specific needs each set comes complete with the Flush Fit tray, Flush Fit mat in one of five striking colours, flexible shower track and curtain. In addition you can opt for a full height shower panel, in clear or frosted unbreakable polycarbonate, 750mm half height corner or front entry shower doors. So now you can enjoy a level entry shower that has been designed and created just for you.

### THE SHOWER TRAY

- Flush fitting, ideal for small bathrooms.
- Bathroom door can open across the tray.
- Heavy GRP construction for strength and durability.
- A range of sizes to suit most requirements.
- Easy to install. Only 25mm deep.
- No need to notch joists on a wooden floor.
- Approximately 25mm to remove on a concrete floor.
- Tile upstand on one long and one short end.
- For high output shower units the shower should be positioned at the waste outlet end of the tray.



Showering

## Flush Fit Mats

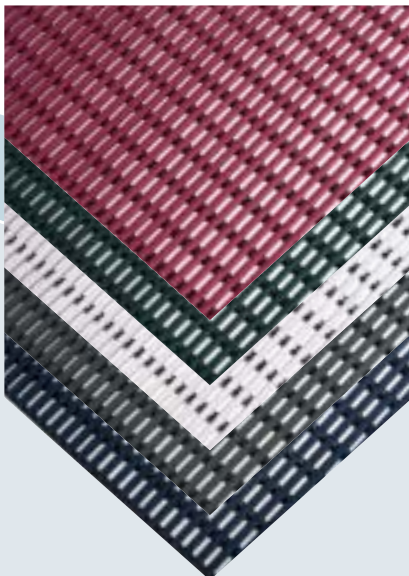

- Feels warm and comfortable.
- Lightweight, flexible and easy to clean.
- No lifting tool required.
- 4 way drainage.
- Resistant to oil and greases.
- Available in 5 colours.
- Provides contrast for the partially sighted.
- Replacement coloured mat available separately.
- Contains Sanitised®

#### Sanitised® helps to:

- Protect against bacterial and fungal attack
- Protect against rotting
- Prevent microbially caused discolouration
- Hinder the growth of algae

For Showers See Page 93-95

## Flush Fit Option A



### TRAY SIZE 1500 x 860MM

P6821705 - L/H, Colour White	P6821720 - R/H, Colour White
P6821706 - L/H, Colour Red	P6821721 - R/H, Colour Red
P6821707 - L/H, Colour Blue	P6821722 - R/H, Colour Blue
P6821708 - L/H, Colour Green	P6821723 - R/H, Colour Green
P6821709 - L/H, Colour Grey	P6821724 - R/H, Colour Grey

### TRAY SIZE 1060 x 1060MM

P6821710 - L/H, Colour White	P6821710 - R/H, Colour White
P6821711 - L/H, Colour Red	P6821711 - R/H, Colour Red
P6821712 - L/H, Colour Blue	P6821712 - R/H, Colour Blue
P6821713 - L/H, Colour Green	P6821713 - R/H, Colour Green
P6821714 - L/H, Colour Grey	P6821714 - R/H, Colour Grey

### OPTION 'A' COMPRISES

- Flush Fit shower tray
- Flush Fit mat
- Flexible shower track 2400mm
- Shower curtain 2135 x 2135 mm.

Only recommended for larger trays as we suggest that the curtain is positioned 100mm into the tray.

## Flush Fit Option B



### TRAY SIZE 1500 x 760MM

P6821725 - L/H, Colour White	P6821740 - R/H, Colour White
P6821726 - L/H, Colour Red	P6821741 - R/H, Colour Red
P6821727 - L/H, Colour Blue	P6821742 - R/H, Colour Blue
P6821728 - L/H, Colour Green	P6821743 - R/H, Colour Green
P6821729 - L/H, Colour Grey	P6821744 - R/H, Colour Grey

### TRAY SIZE 1500 x 860MM

P6821730 - L/H, Colour White	P6821745 - R/H, Colour White
P6821731 - L/H, Colour Red	P6821746 - R/H, Colour Red
P6821732 - L/H, Colour Blue	P6821747 - R/H, Colour Blue
P6821733 - L/H, Colour Green	P6821748 - R/H, Colour Green
P6821734 - L/H, Colour Grey	P6821749 - R/H, Colour Grey

### TRAY SIZE 1060 x 1060MM

P6821735 - L/H, Colour White	P6821735 - R/H, Colour White
P6821736 - L/H, Colour Red	P6821736 - R/H, Colour Red
P6821737 - L/H, Colour Blue	P6821737 - R/H, Colour Blue
P6821738 - L/H, Colour Green	P6821738 - R/H, Colour Green
P6821739 - L/H, Colour Grey	P6821739 - R/H, Colour Grey

### OPTION 'B' COMPRISES

- Flush Fit shower tray
- Flush fit mat
- Frosted finish shower panel 700 x 1880 mm
- Flexible shower track 2400mm
- Shower curtain 1830 x 1830 mm.

To achieve front entry (as illustrated) or corner entry

For Shower Seats See Page 96-99



## Flush Fit Option C

### TRAY SIZE 1500 X 760MM

P6821750 - L/H, Colour White	P6821765 - R/H, Colour White
P6821751 - L/H, Colour Red	P6821766 - R/H, Colour Red
P6821752 - L/H, Colour Blue	P6821767 - R/H, Colour Blue
P6821753 - L/H, Colour Green	P6821768 - R/H, Colour Green
P6821754 - L/H, Colour Grey	P6821769 - R/H, Colour Grey

### TRAY SIZE 1500 X 860MM

P6821755 - L/H, Colour White	P6821770 - R/H, Colour White
P6821756 - L/H, Colour Red	P6821771 - R/H, Colour Red
P6821757 - L/H, Colour Blue	P6821772 - R/H, Colour Blue
P6821758 - L/H, Colour Green	P6821773 - R/H, Colour Green
P6821759 - L/H, Colour Grey	P6821774 - R/H, Colour Grey

### TRAY SIZE 1060 X 1060MM

P6821760 - L/H, Colour White	P6821760 - R/H, Colour White
P6821761 - L/H, Colour Red	P6821761 - R/H, Colour Red
P6821762 - L/H, Colour Blue	P6821762 - R/H, Colour Blue
P6821763 - L/H, Colour Green	P6821763 - R/H, Colour Green
P6821764 - L/H, Colour Grey	P6821764 - R/H, Colour Grey

### OPTION 'C' COMPRISES

- Flush Fit shower tray
- Flush Fit Mat
- Clear finish shower panel 700 x 1880 mm
- Flexible shower track 2400mm



## Flush Fit Option D

### TRAY SIZE 1500 X 760MM

P6821775 - L/H, Colour White	P6821795 - R/H, Colour White
P6821776 - L/H, Colour Red	P6821796 - R/H, Colour Red
P6821777 - L/H, Colour Blue	P6821797 - R/H, Colour Blue
P6821778 - L/H, Colour Green	P6821798 - R/H, Colour Green
P6821779 - L/H, Colour Grey	P6821799 - R/H, Colour Grey

### TRAY SIZE 1500 X 860MM

P6821780 - L/H, Colour White	P6821800 - R/H, Colour White
P6821781 - L/H, Colour Red	P6821801 - R/H, Colour Red
P6821782 - L/H, Colour Blue	P6821802 - R/H, Colour Blue
P6821783 - L/H, Colour Green	P6821803 - R/H, Colour Green
P6821784 - L/H, Colour Grey	P6821804 - R/H, Colour Grey

### TRAY SIZE 960 X 960MM

P6821785 - L/H, Colour White	P6821785 - R/H, Colour White
P6821786 - L/H, Colour Red	P6821786 - R/H, Colour Red
P6821787 - L/H, Colour Blue	P6821787 - R/H, Colour Blue
P6821788 - L/H, Colour Green	P6821788 - R/H, Colour Green
P6821789 - L/H, Colour Grey	P6821789 - R/H, Colour Grey

### OPTION 'D' COMPRISES

- Flush Fit shower tray
- Flush Fit mat
- Pair corner entry Bi-fold doors frosted finish 750 mm high
- Flexible shower track 2400mm
- Shower curtain 2135 x 2135 mm.



Showering

For Showers See Page 93-95

## Flush Fit Option D



### TRAY SIZE 1060 x 1060MM

P6821790 - L/H, Colour White	P6821790 - R/H, Colour White
P6821791 - L/H, Colour Red	P6821791 - R/H, Colour Red
P6821792 - L/H, Colour Blue	P6821792 - R/H, Colour Blue
P6821793 - L/H, Colour Green	P6821793 - R/H, Colour Green
P6821794 - L/H, Colour Grey	P6821794 - R/H, Colour Grey

### OPTION 'C' COMPRISES

- Flush Fit shower tray
- Flush Fit mat
- Pair corner entry Bi-fold doors frosted finish 750 mm high
- Flexible shower track 2400mm
- Shower curtain 2135 x 2135 mm.

## Flush Fit Option E



### TRAY SIZE 1500 x 760MM

P6821805 - L/H, Colour White	P6821825 - R/H, Colour White
P6821806 - L/H, Colour Red	P6821826 - R/H, Colour Red
P6821807 - L/H, Colour Blue	P6821827 - R/H, Colour Blue
P6821808 - L/H, Colour Green	P6821828 - R/H, Colour Green
P6821809 - L/H, Colour Grey	P6821829 - R/H, Colour Grey

### TRAY SIZE 1500 x 860MM

P6821810 - L/H, Colour White	P6821830 - R/H, Colour White
P6821811 - L/H, Colour Red	P6821831 - R/H, Colour Red
P6821812 - L/H, Colour Blue	P6821832 - R/H, Colour Blue
P6821813 - L/H, Colour Green	P6821833 - R/H, Colour Green
P6821814 - L/H, Colour Grey	P6821834 - R/H, Colour Grey

### OPTION 'E' COMPRISES

- Flush Fit shower tray
- Flush Fit mat
- One pair Bi-fold doors frosted finish 750 mm high
- Flexible shower track 2400mm
- Shower curtain 1830 x 1830 mm.

## Flush Fit Installation Quick Guide

- Remove floor boards (no need to reduce joists) infill between joists or remove sufficient screed on concrete floors.
- Fix waste to tray and solid bed the tray into position.
- Tile the walls over the tiling lip on to the tray (leaving gap for sealant).
- Lay ply boards to bathroom (timber board floor) followed by floor covering, tucking the flooring under the trays flooring lip
- Finish by applying sealant between floor and tray floor.

The trays are suitable for installation into many sub floor materials, however concrete and timber appear to be the most popular. The floor covering can be butted-up to or under the shower tray, on either concrete or wooden floors.

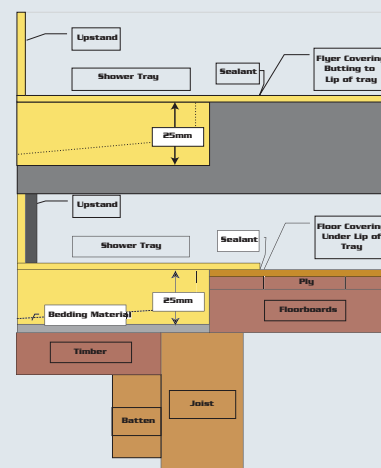

For Shower Seats See Page 96-99

## Phlexicare Level Dec

Level access showering for both the independent living and domestic market is becoming more of a necessity and everyday requirement. Awkward access with high steps, lips and ramps are inconvenient unsightly, and often a hazard.

The Phlexicare Level Dec provides a very cost effective answer in truly level access showering and takes away the risk of creating your own falls on both timber and solid floors.

The Phlexicare Level Dec provides a preformed solid floor former in shower areas that is only the depth of a floor board. When the Level Dec is set level with the existing floor then any suitable proprietary flooring such as Altro, Tarasafe, Safetread etc. can be laid over the whole floor including the shower area to its own low depth clampable gully.

- Complete level access.
- For timber and solid floors.
- Weight limit up to 256kg
- Easy to install. Only 22mm deep.
- No need to notch joists on a wooden floor.
- Gradient of 1:40 to drainage.
- Complete package includes tray, doors, curtain and track.
- 10 year warranty.



Showering

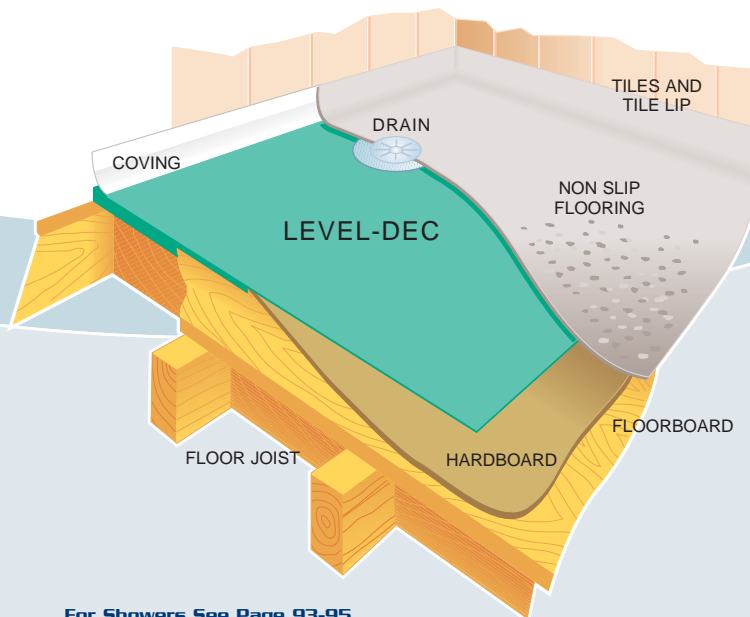

For Showers See Page 93-95

## Phlexicare Level Dec **Option 1**

The Level Dec comes complete with:

- Level Dec Tray
- 750mm high Bi-fold Frosted Shower Doors
- Shower Curtain
- Flexible Shower Track

**P6821895** - 910mm x 910mm  
Max shower area 870mm x 870mm

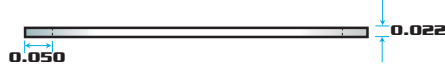
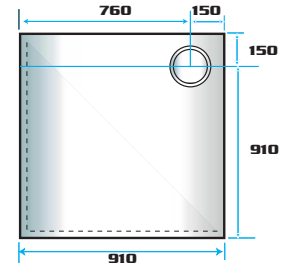

## **Option 2** **Option 3**

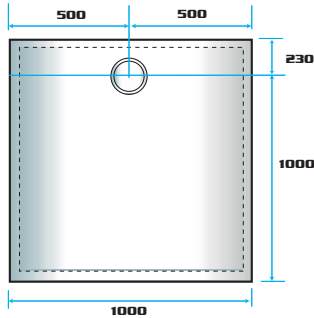

**P6821896** - 1000 x 1000  
Max shower area 960mm x 960mm

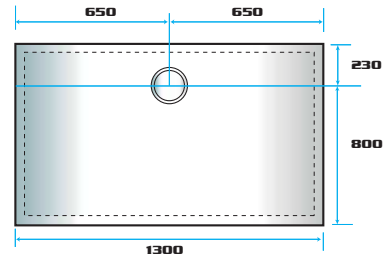

**P6821897** - 1300 x 800 L/H  
**P6821898** - 1300 x 800 R/H  
Max shower area 1250mm x 780mm

## **Option 4** **Option 5**

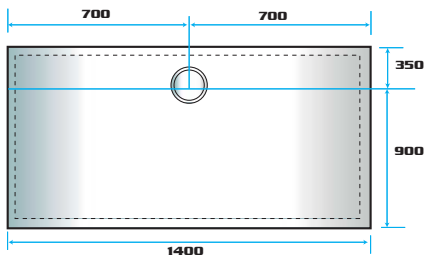

**P6821899** - 1400 x 900 L/H  
**P6821900** - 1400 x 900 R/H  
Max shower area 1350mm x 880mm

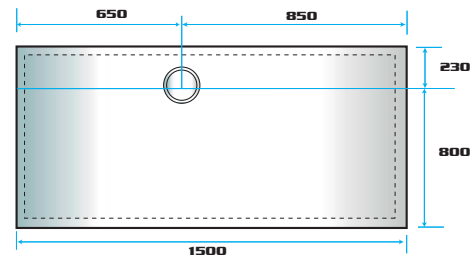

**P6821901** - 1500 x 800 L/H  
**P6821902** - 1500 x 800 R/H  
Max shower area 1450mm x 780mm

## Shower Gully for Wet Floors



**S2370511** - Trapped shower gully with 75mm seal. Top access for easy cleaning flexible sheet flooring on concrete or suspended timber floors.  
Overall depth-130mm

## Pumped Waste for Wet Floor

**P6821589** - This system comprises of a shallow easy to clean gully for wet floor shower areas. Together with the Whale Gulper pump it is capable of clearing up to 8 litres of water per minute. Kit comprises of shallow gully, pump, transformer and flow switch.  
Overall depth - 45mm



For Shower Seats See Page 96-99

## Phlexicare Pumped Waste System

**P6821490** - This pumped waste system has been designed to handle a respectable 6 to 10 litres per minute as standard. If utilising a typical domestic shower system which delivers at around 6 litres per minute, the performance of the pumped waste system is extremely quiet. The transparent inline filter which enables routine maintenance can be opened with the use of only one hand.



## Top Waste Exit Kit



**P6821491** - If the shower tray has to be sited straight on to a solid floor, or if the floor doesn't allow under-floor plumbing, how can a shower be installed at home? The Phlexicare top waste exit kit provides an effective solution. It places a suction nozzle on the shower tray which sucks up the waste water and distributes it to external plumbing.

**P6821500** - Chrome Elbow

## Bottom Waste Exit Kit

**P6821492** - This enables use of a conventional shower installation, but this kit has an integral unit, which can be easily removed and cleaned by the user. 90mm deep.



## Shallow Bottom Waste Exit Kit



**P6821493** - This very shallow waste fitting is suitable for connecting to the Phlexicare pumped waste system 40mm deep.

## Flow Switch System

**P6821494** - As standard, the Phlexicare pump can be used with a pull cord switch. The Flow switch option is an alternative to the pull cord. Located in the cold supply line to the shower, when the shower is turned on the waste pump switches on automatically. Switching off the shower causes the cold supply to stop, which switches off the waste pump.



For Shower Trays and Doors See Page 75-90



### Filter Free with Auto Gully



**P6821503** - The new Phlexicare Filter Free pump is a low noise virtually maintenance free pump which does not require an in line filter. The patented float switch turns the pump on only when there is water in the tray.



- Up to 12 litres per min flow rate
- Variable speed to suit flow rate
- Auto start gully
- Self priming (to 1 metre)
- 24V motor-via 5 amp unswitched spur
- Max. head pressure 3 metres
- Brass pump head

### Filter Free with Top Waste Exit Kit



**P6821502** - The new Phlexicare Filter Free pump is a low noise virtually maintenance free pump which does not require an in line filter. The patented float switch turns the pump on only when there is water in the tray.



- Up to 8 litres per min flow rate
- Variable speed to suit flow rate
- Auto start gully
- Self priming (to 1 metre)
- 24V motor-via 5 amp unswitched spur
- Max. head pressure 3 metres
- Brass pump head

### Whale Pumped Waste System



Super powerful and virtually maintenance free. Comes complete with top and bottom waste kit. No inline filter required.

**P6821590** - Automatic with flow switch

**P6821598** - Manual without flow switch

### Gravity Waste Trap



**S2370501** - A carefully designed waste fitting system which can be accessed from the top of the shower tray. Once fitted, the grating is removed and the dip tube is inserted into the sump - it now forms the entry to the trap - and the grating is then refitted. This both simplifies installation and allows top clearance of blockages.

For Shower Trays and Doors See Page 75-90

## Phlexiscreen

**P6821595** - Phlexiscreen, the simple and ingenious solution to splash proofing and modesty. It's lightweight but strong construction makes it completely hygienic and waterproof. It can be stored and deployed in seconds and be bent by hand to form curves or an angled bay to suit your every requirement. No hinges, seals, rubber strips.

Length 1500mm Height 800mm

Colour Soft white



## Nimbus 8.5kw Shower

Phlexicare Nimbus 8.5kw electric shower, compact, reliable, convenient. Everything a user needs from an electric shower. Designed with function and performance in mind, the Phlexicare Nimbus electric shower features simple operation and ease of installation.

- Powerful 8.5kw unit.
- Large separate start/stop push button.
- Choice of 3 power settings COLD: MEDIUM: HIGH
- All parts replaceable ensuring long term reliability.
- Separate temperature dial.
- Stabilisation valve helps ensure the water temperature remains constant
- Thermal safety cut-out.
- Dual spray handset with rub clean anti-limescale system and large bore flexible shower hose.
- BEAB and CE approved.
- Rapid service call out.

INLET	15mm compression
OUTLET	1/2" BSP
ELECTRICAL SUPPLY	220/240v, 50HZ
MAXIMUM INLET PRESSURE	10 bar
MINIMUM INLET PRESSURE	1 bar

**P5280810** - Nimbus 8.5kw Electric Shower



Showering

Dual Spray Handset



All wiring must comply with current IEE regulations. The shower must be permanently connected to the electrical supply through a double pole switch with a minimum contact gap of 3mm and minimum break capacity of 40 amps.

For Shower Trays and Doors See Page 75-90

## Electratherm 9.6kw Shower

Phlexicare's Safe Electric Shower incorporates the very best of safe showering technology today. Thermostatic sensitivity combined with real power and performance allows the user to control the ultimate electric shower experience.

- Thermostatically limited to a nominal 43°C.
- Powerful 9.6kw unit.
- Large separate start/stop push button.
- Digital temperature dial allows variable control from cold right through to high.
- Digital temperature display.
- Stabilisation valve helps ensure the temperature remains constant.
- Thermal safety cut-out.
- Dual spray hand set with rub clean anti-limescale system and large bore hose.
- 1500mm flexible shower hose.
- BEAB and CE approved.

INLET	15mm compression
OUTLET	1/2" BSP
ELECTRICAL SUPPLY	220/240v, 50HZ
MAXIMUM INLET PRESSURE	10 bar
MINIMUM INLET PRESSURE	1 bar

P5280800 - Electratherm 9.6kw Shower

P5280801 - Extended Riser Rail 1200mm (optional)



Dual Spray Handset

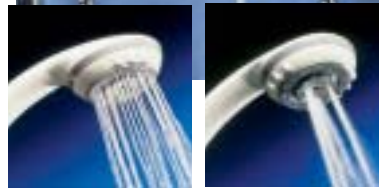

## PHX43 8.7kw Shower

The Phlexicare PHX43 incorporates all the qualities required for a safe, yet pleasurable shower.

The built-in showersafe feature prevents harmful temperatures above 43°C being reached.

The shower constantly monitors the water temperature and makes instant adjustments in the event of water pressure reductions, including a complete shutdown of the system if it were detected that the temperature could exceed 45°C.

The unit even tells you when your showerhead needs cleaning.

- Temperature controlled for safer showering
- Powerful 8.7kw unit.
- Showersafe feature.
- Phased shutdown.
- Extra long shower hose (1.25 mtrs) soap dish and high performance shower head.
- Slim elegant design.
- BEAB and CE approved.

INLET	15mm compression
OUTLET	1/2" BSP
ELECTRICAL SUPPLY	230/240v, 50HZ
MAXIMUM INLET PRESSURE	10 bar
MINIMUM INLET PRESSURE	0.8 bar

P5280805 - PHX43 8.7kw Shower



All wiring must comply with current IEE regulations. The shower must be permanently connected to the electrical supply through a double pole switch with a minimum contact gap of 3mm and minimum break capacity of 40 amps.

For Shower Trays and Doors See Page 75-90

## Phlexicare Shower Pack

Simple, cost-effective and easy to install, this complete shower kit is ready-made for speedy installation into almost any environment.

It caters for connection to gravity-fed, high pressure or uneven pressure systems.

The control unit incorporates a temperature protection function in that the water output temp is set to 41°C (but this can be varied at time of installation between 15° C and 51°C). This operation temperature, once selected, is fully thermostatically controlled and accidental scalding is impossible. The control knob has a handle extension enabling easier operation.

- Fitting for exposed pipework
- Fitting for concealed pipework
- Complete with riser rail, shower head and hose

### SHOWER PACK

P6820101 - Phlexicare Exposed and Concealed Fittings Chrome Finish



## Opac Thermostatic Shower Mixer

The Opac has been designed to make showering a breeze. The ergonomically designed lever provides easy purchase to allow operation of both water flow and temperature. Once set, the thermostatic control technology maintains the chosen temperature, regardless of other water users.



- Instant thermostatic shut-off.
- Factory set at 43°
- Simple lever control for on/off and temperature control.
- Brass body ensures longevity in hard water areas.
- Compatible with any plumbing system.



### OPAC LEVER ACTION THERMOSTATIC MIXER

P6820145 - Exposed Fittings Chrome Finish  
P6820146 - Concealed Fittings Chrome Finish

For Shower Kits See Page 208

Showering



### Classic Folding Shower Seat



Strong stylish design incorporating ease of use, colour and height adjustment. The seats are produced in polypropylene and are available in six striking colours.

- Maximum Weight 150 kilos
- Seat Projection 410mm
- Seat Width 470mm

- P6828702 - White
- P6828695 - Blue
- P6828698 - Red
- P6828697 - Yellow
- P6828696 - Green
- P6828699 - Black



### Classic Folding Shower Seat with arms and back rest



P6828707 - Secures Directly to Wall and Features Soft Padded Armrests and a Flip-up Folding Mechanism.

- Maximum Weight 150 kilos
- Seat Projection 550mm
- Seat Width 575mm

### Comfort Folding Shower Seat with arms and back rest



- Maximum Weight 150 kilos
- Seat Projection 550mm
- Seat Width 575mm

- P6828692 - Comfort Folding Shower Seat with Arms and Back Rest
- P6828694 - As above with Padded Horseshoe Seat

### Comfort Folding Shower Seat with aperture



- Maximum Weight 150 kilos
- Seat Projection 550mm
- Seat Width 450mm

P6828693 - Comfort Folding Shower Seat with Aperture

All Seats Are Variable Height

For Shower Trays and Doors See Page 75-90



## Broadgate Folding Shower Seat

**P6824501** - Folds against the wall for storage, lets down securely for wheelchair transference. Stainless steel guide rod always ensures front support frame is in the correct position. Comfortable extruded PVC slats, white finished frame.

- Maximum Weight 150 kilos
- Seat Width 400mm
- Seat Projection 380mm
- Arm Projection 475mm



## European Folding Shower Seat

**P6824102** - The European seat folds down from its against-wall storage position to aid transfer to and from a wheelchair. The modern European look is conveyed by natural ash-finished PVC slats.

- Maximum Weight 150 kilos
- Seat Width 600mm
- Seat Projection 450mm
- Arm Projection 500mm



## Siesta Shower Seat

**P6824001** - Suitable for more able persons, this compact Shower Seat is ideal for domestic and other confined shower installations. White ABS plastic seat.

- Maximum Weight 100 kilos
- Seat Projection 320mm
- Seat Width 320mm



## Padded Shower Seat

**P6828718** - Padded Shower seat

- Maximum Weight 125 kilos
- Seat Projection 335mm
- Seat Width 340mm



## Padded Shower Bench

**P6828719** - For the larger person, this Padded Shower Bench provides the same comfort as the shower seats above, but confers additional benefits as it is height-adjustable, and has a deeper, larger padded seating area.

- Maximum Weight 125 kilos
- Seat Projection 330mm
- Seat Width 460mm



For Shower Trays and Doors See Page 75-90

## Power Operated Shower Bench

This Shower Bench, made from PVC, canvas and nylon-coated tubular steel is fully electrically adjustable for height within a 400mm range. Maximum operational weight of 150kg. Total Projection 750mm height from floor 500mm - 900mm.

- P6825211 - 1400mm model
- P6825221 - 1800mm model
- P6825311 - Folding Guard Rail

### SPLASH CURTAIN

- P6825312 - White 1400mm
- P6825313 - White 1800mm



## Pressalit Care Shower Seat

- Anatomically shaped seat for comfort
- Option of open fronted design for intimate hygiene
- Ample size for full support and ease of cleaning
- Slip resistant removable seat and backrest for easy cleaning
- Optional retractable support leg.
- Maximum load 125kg.
- Fixings Included

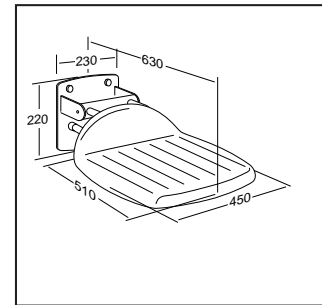

**Folding Seat**

**P6823822** - Projection folded 170mm without aperture

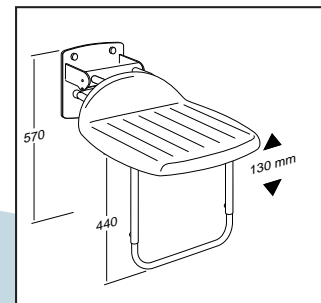

**Folding Seat**

**P6835452** - Projection folded 220mm with support leg

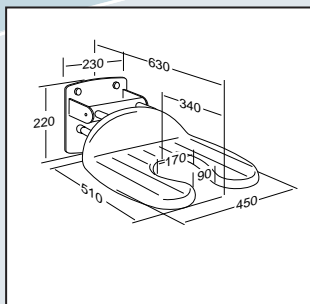

**Folding Seat**

**P6823823** - Projection folded 170mm with aperture

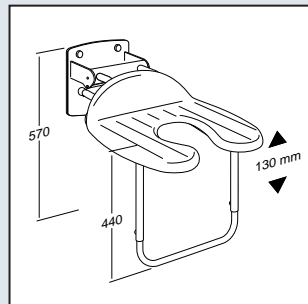

**Folding Seat**

**P6823831** - Projection folded 220mm with aperture and leg support

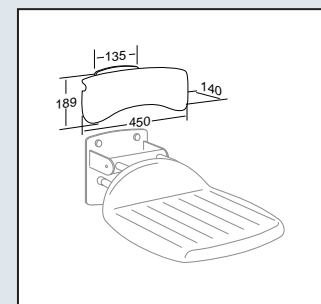

**Back Rest**

**P6823824** - for folding seat

For Shower Trays and Doors See Page 75-90

**Pressalit Rehab Shower Chair**



- Height adjustable chair for multiple and changing needs
- Easy release locking device for instant adjustment
- Extra projection (750 mm) gives ample space for carers and easier transfer
- Available with independently folding support arms
- Optional backrest clipped to side supports for sitting to the left or right
- Maximum load 150kg.

Showering

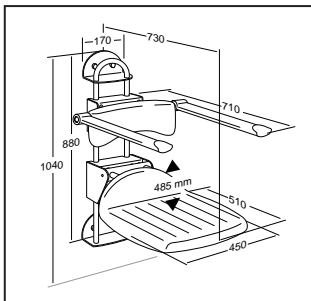

**SHOWER CHAIR**

**P6823828 - Projection Folded 270mm with Support Arms**

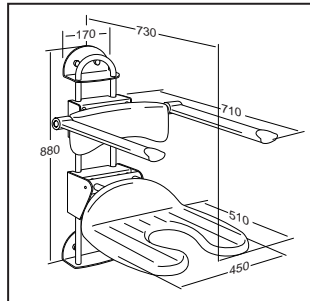

**SHOWER CHAIR**

**P6823829 - Projection Folded 270mm**

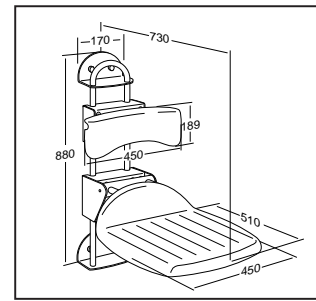

**SHOWER CHAIR**

**P6823826 - Projection Folded 270mm**

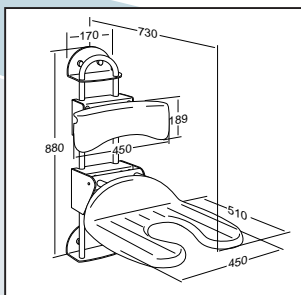

**SHOWER CHAIR**

**P6823827 - Projection Folded 270mm with Aperture**

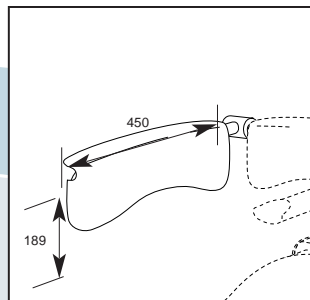

**SIDE SUPPORT LEFT**

**P6823840**

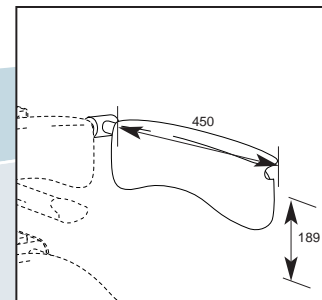

**SIDE SUPPORT RIGHT**

**P6823841**

For Shower Trays and Doors See Page 75-90

## Multi System

The Pressalit Multi System is a way to cater safely for the very special needs of the very special person and still have up-to-the-minute style and ease of use as well. The entire concept of an integrated collection of bathroom and W.C. accessories and facilities revolves around the use and installation of the Pressalit Multi Track, to which as many accessories or facilities as you desire are mounted.

- Vertical and horizontal adjustment
  - Interchangeable
  - Flexible mounting
  - Ergonomically shaped grip
  - Max. Load
- Support arm: 135kg  
 Shower chair: 150kg  
 Folded seat: 135kg  
 Toilet seats: 150kg

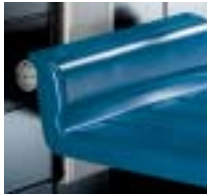

3 year guarantee

### Support Arm Fixed Height



- P6836001 - White
- P6836002 - Red
- P6836003 - Blue

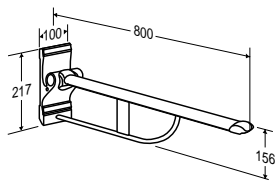

### Support Arm Vertical Adjustment



Vertical Support - 400mm (adj within 250mm)

- P6836011 - White
- P6836012 - Red
- P6836013 - Blue

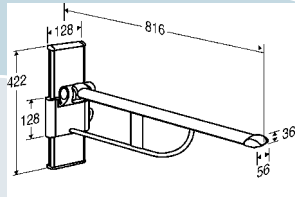

Fixed height
 
◀
▶
 Horizontally adjustable
 
▲
▼
 Vertically adjustable
 
◀
▶
▲
▼
 Horizontally and Vertically adjustable

For Full Colour Range See Page 105

**Horizontal Multi Track**



**PRESSALIT HORIZONTAL MULTI TRACK**

- P6836502 - 600 mm
- P6836503 - 900 mm
- P6836504 - 1200 mm
- P6836505 - 1500 mm
- P6836506 - 1800 mm
- P6836507 - 2100 mm
- P6836508 - 2400 mm
- P6836509 - 2700 mm
- P6836510 - 3000 mm
- P6836511 - 3300 mm
- P6836512 - 3600 mm
- P6836513 - 3900 mm

**Support Arm Track Fixing Horizontal Adjustment**



- P6836031 - White
- P6836032 - Red
- P6836033 - Blue

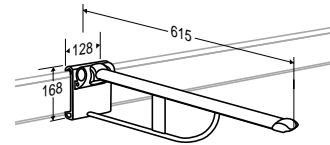

**Support Arm Two Way Adjustment**



Vertical Support - 400mm (adj within 250mm)

- P6836041 - White
- P6836042 - Red
- P6836043 - Blue

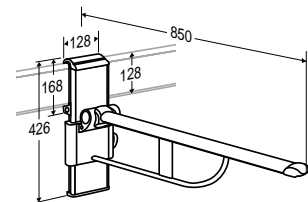

**Toilet Tissue Roll Attachment**



P6836061 - Toilet Tissue Roll Attachment

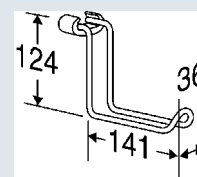

For Full Colour Range See Page 105



**Wash Basin Brackets Adjustable Assemblies**

**COUNTER BALANCED:**

- Easy release locking lever
- Increases projection of basin
- Easy for carers to adjust

**ELECTRICALLY OPERATED:**

- Light touch control lever for automatic adjustment
- 24 volt motor with transformer safe in wet areas

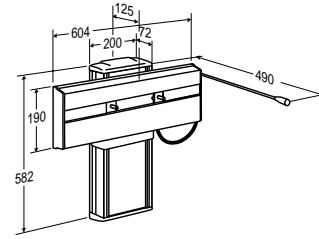

**P6836151 - Gas Cylinder**

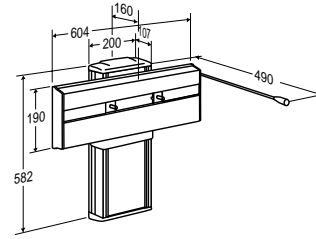

**P6836161 - Electric Motor**

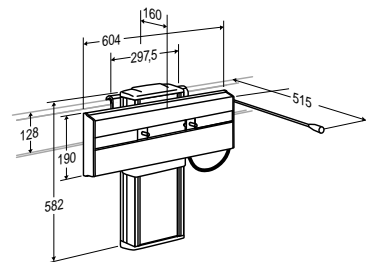

**P6836141 - Gas Cylinder**

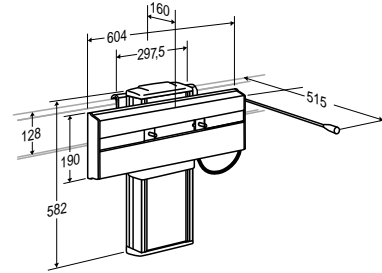

**P6836171 - Electric Motor**

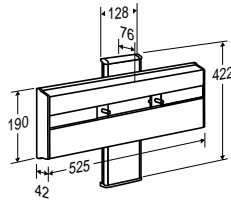
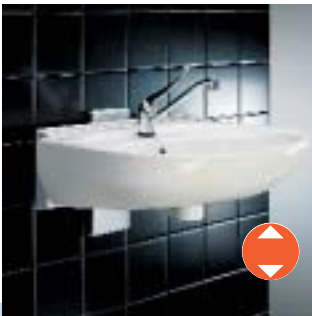

**P6836101 - Manually Operated**



**Fixed height**



**Horizontally adjustable**



**Vertically adjustable**



**Horizontally and Vertically adjustable**

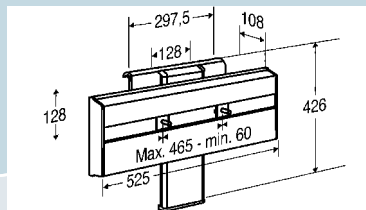

**P6836131 - Manually Operated**

**Flexible Feed and Waste System for Wash Basin Assemblies**



**P6843420 - Feed 700mm Waste 700mm**

**P6843415 - Feed 1200mm - Waste 1500mm**

**S2372001 - C.P. Bottle Trap**

For Wash Basins See Page 47

## Shower Chairs

IT IS NICE TO HAVE A SHOWER  
ESPECIALLY WHEN YOU CAN BE SEATED SAFELY AND COMFORTABLY  
ALL SHOWER CHAIRS ARE AVAILABLE WITH OR WITHOUT APERTURE

### Shower Chair

#### BACKREST FIXED

- P6836610 - White
- P6836611 - Red
- P6836612 - Blue

#### SHOWER CHAIR VERTICAL

Projection folded up: 210mm  
Range of vertical adjustment: 250mm

- P6823655 - White
- P6823656 - Red
- P6823657 - Blue

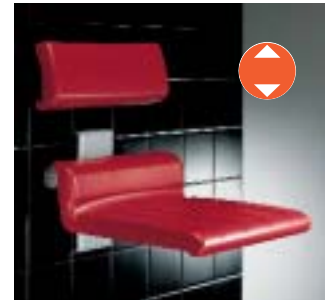
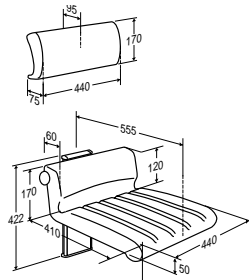

### Shower Chair with Back Rest

#### SHOWER CHAIR VERTICAL WITH BACK REST

Projection folded up: 210mm  
Range of vertical adjustment: 340mm

- P6823661 - White
- P6823662 - Red
- P6823663 - Blue

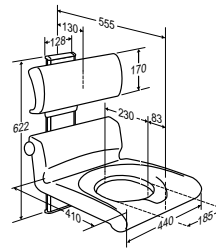

Drawing shows seat with aperture details available on request

### Shower Chair with Back Rest and Arms

#### SHOWER CHAIR VERTICAL WITH BACK REST AND ARMS

Projection folded up: 210mm  
Range of vertical adjustment: 340mm

- P6823671 - White
- P6823672 - Red
- P6823673 - Blue

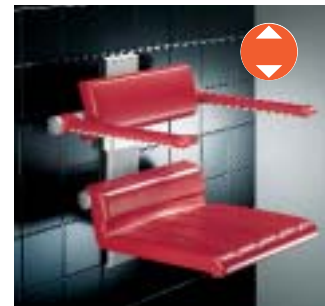
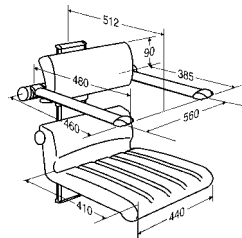

### Shower Chair with Back Rest and Arms

#### SHOWER CHAIR TWO WAY ADJUSTMENT WITH BACK REST AND ARMS

Projection folded up: 240mm  
Range of vertical adjustment: 330mm

- P6823675 - White
- P6823676 - Red
- P6823677 - Blue

#### Without Arms

- P6823665 - White
- P6823666 - Red
- P6823667 - Blue

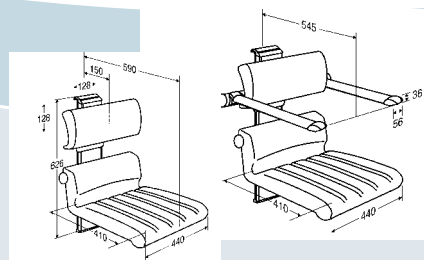

Options: All models are available with drainage channels or with aperture.

### Folding Seat Fixed



- P6823501 - White
- P6823502 - Red
- P6823506 - Blue

Projection Folded: 95mm

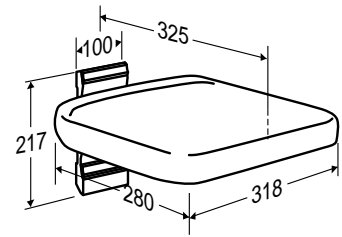

### Folding Seat Vertical



- P6823511 - White
- P6823512 - Red
- P6823516 - Blue

Projection Folded: 120mm

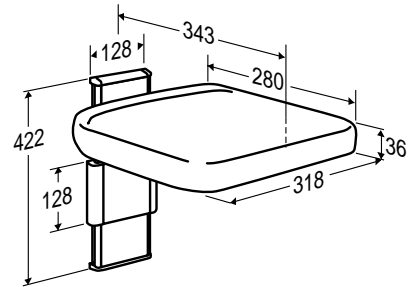

### Folding Seat Two Way Adjustment



- P6823531 - White
- P6823532 - Red
- P6823536 - Blue

Projection Folded: 150mm

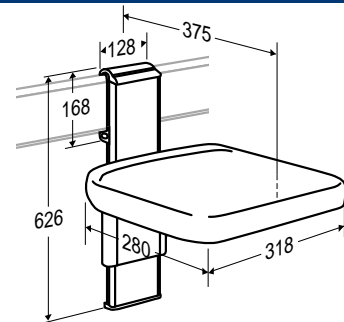

### Shower Mixer Bracket Attachment



Including flexible Feed Pipes

- P6836007 - Bracket

Centre distance for mixer 151mm.

1200mm pipes attached

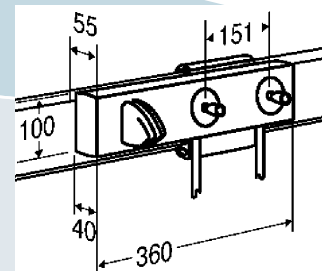

### Grab Rail Horizontal

Grab Rail with Horizontal Adjustment.

- |                         |                       |                        |
|-------------------------|-----------------------|------------------------|
| P6836620 - 450mm White  | P6836624 - 450mm Red  | P6836628 - 450mm Blue  |
| P6836621 - 600mm White  | P6836625 - 600mm Red  | P6836629 - 600mm Blue  |
| P6836622 - 800mm White  | P6836626 - 800mm Red  | P6836630 - 800mm Blue  |
| P6836623 - 1000mm White | P6836627 - 1000mm Red | P6836631 - 1000mm Blue |

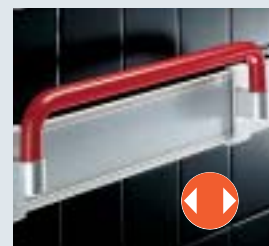

For Full Colour Range See Page 105

## Modular Shelves Fixed Wall Position

### MODULAR SHELVES FIXED WALL POSITION

P6836519 - 600mm Rod including Two Shelves  
Towel Rail and Two Trays

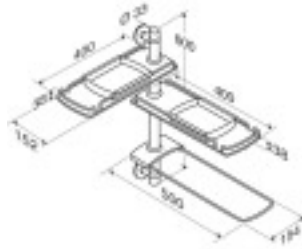

## Modular Shelves Multi-Track Mounted

### MODULAR SHELVES MULTI-TRACK MOUNTED

P6836521 - 600mm Rod including Two Shelves  
Towel Rail and Two Trays

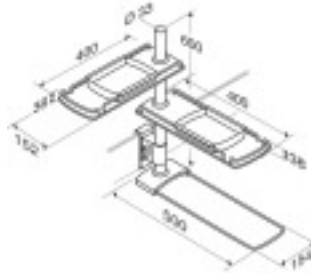

## Shower Curtain

### SHOWER CURTAIN

P6836005 - White  
P6836006 - Patterned

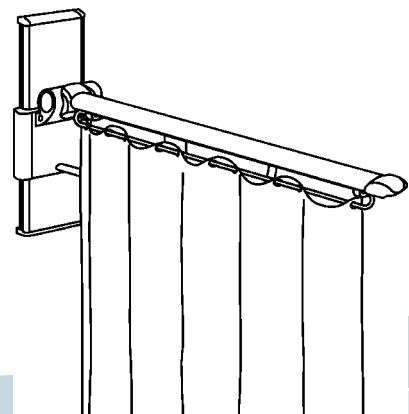
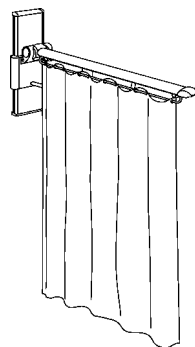

Please order support arm separately see page 100

## Full Pressalit Colour Range



Grey



Blue



White



Turquoise



Red

Full Design Service Available on Request

## Ropox Height Adjustable Wash Basin



This electronically operated height adjustable wash basin assembly is suitable for all members of the family, whether ambulant or wheelchair users.

With light pressure of the up/down button, the basin can be adjusted from between 600mm and 1000mm from the floor.

**P6815540** - Ropox Height Adjustable Wash Basin Assembly complete with Mirror and Shelf

**P6815541** - Light Fixture

**P7004016** - Olympus Wash Basin 550mm Taphole 1

**P7004017** - Olympus Wash Basin 550mm Taphole 2

**P6810642** - Basin Fixing Bolt Set

**P6843415** - Flexible Plumbing Kit

## Neptune Thermostatic Bath/Shower Mixer



Safe, invigorating thermostatic shower performance coupled with thermostatically controlled bath fill, Neptune brings together the best of both worlds. Simple operation, the Neptune has a single sequential control that operates from the off position, through cold to hot.

- Instant thermostatic shut-off.
- Factory set at 43°C.
- Safe temperature delivery to both bath and shower.
- Brass body ensures longevity in hard water areas.
- 22mm flexible inlet connectors with built-in service isolation valves.

**P6820104** - Neptune Thermostatic Bath/Shower Mixer  
Finish Chrome Plated

## Safty Thermostatic Mixing Valves



These Phlexicare valves are ideal for tap or shower use in hospitals, schools, leisure centres, industrial washrooms, carer facilities or domestic housing. Being factory-preset and incorporating a flow control device, each provides safe delivery of hot water and eliminates the risk of scalding, in line with NHS Estates Guidelines and BS1415 Part II. Maximum user-selectable temperature is thus 43° C, although special override procedures by authorised personnel allow resetting of maximum temperature from 38° C to 65° C. Two sizes of safety mixing valves are available: 15mm and 22mm for installation with baths or shower equipment.

**P6349090** - 15mm Safety Thermostatic Mixing Valves  
Finish Chrome Plated

**P6349091** - 22mm Safety Thermostatic Mixing Valves  
Finish Chrome Plated

For Wash basins See Page 47



## Presflo Basin Waste 32mm

An ingenious design where water-pressure from water in the basin keeps the plug closed. Simple finger pressure on either part of the plug allows it to rotate in its housing, which allows water to flow past it and away, thus emptying the basin. Perfect for installation where those with limited muscular control will need to activate a basin's drain plug for themselves, or where plugs are continually being lost. For vitreous china washbasins only. The waste unit is slotted for overflow. Tail screwed - 32mm BSP

P68485.01 - Finish Chrome



## Lever Action Pop Up Waste and Overflow for Bath

The pop-up plug is activated by a small lever attached to the rotating overflow rose. Tail screwed - 38mm BSP

P68408.01 - Finish Chrome



## Sink Waste and Combined Overflow

For fixing to kitchen sink tops of practically any design. Supplied with plastic drain plug, chrome-plated metal plug retainer chain and stay.

S23610.11 - 32mm BSP Finish Chrome\*

S23610.01 - 38mm BSP Finish Chrome

\* For use with flexible plumbing kit



## Flexible Plumbing Kit

P6843415 - This is the ideal kit to use with washbasins and sinks in situations where frequent height re-adjustment is required.

- 2 flexible tubes for Hot & Cold supply 1200mm long, connection: 13mm BSP
- Elbow for connecting to tail of waste - 32mm BSP
- PVC flexible waste tube 1500mm
- Fixing adhesive
- Bent tube & multifit connector to trap

Trap not included please specify - S2372001



## Flexible Plumbing Kit

P6843420 - This is the ideal kit to use with washbasins and sinks in situations where frequent height/horizontal re-adjustment is required.

- 2 flexible tubes for Hot & Cold supply 700mm long, connection: 13mm BSP
- Elbow for connecting to tail of waste - 32mm BSP
- PVC flexible waste tube 700mm
- Fixing adhesive
- Bent tube & multifit connector to trap

Trap not included please specify - S2372001



For Wash basins See Page 47

### Dania Toilet Seat

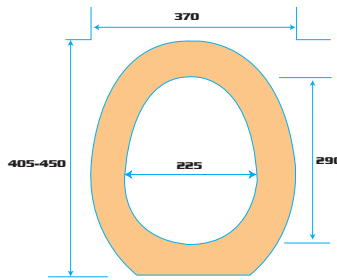

Beautifully designed, the ring seat is smooth and flat to ease transfers from a wheelchair. Special buffers underneath prevent sideways movement and the strong stainless steel hinges are both stable and able to adjust to suit most standard pans.

- P6833814 - White
- P6833815 - White With Cover
- P6833816 - Red With Cover

### Dania Blue Toilet Seat

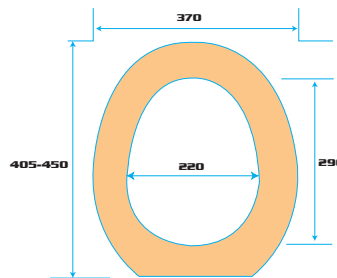

The Dania Blue ring seat is smooth and flat to ease transfers from a wheelchair and offers a good colour contrast against white sanitaryware.

- P6833817 - Blue
- P6833818 - Blue With Cover

### Colani Seat with Cover

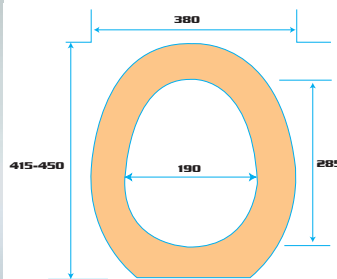

The Colani seat has strong, adjustable stainless steel hinges and heavy-duty underseat buffers which grip the inside or outside of the pan. The seat is ergonomically shaped and the lid doubles as a comfortable backrest.

- P6833201 - White with cover

### Ergosit Toilet Seat

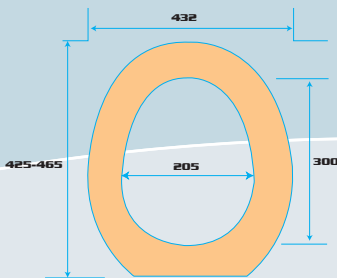

This seat concept which has been designed to support larger people and stimulate bowel movement. The seat is specially ribbed as an aid to airflow and to improve stability. It includes the special Pressalit buffers with extra strong crossbar hinges for extra durability.

- P6833301 - White
- P6833305 - White With cover

### SoftSit

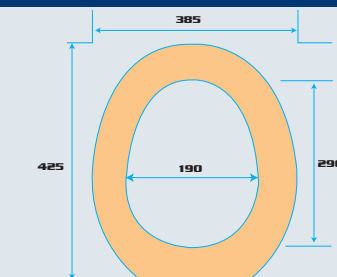

The White SoftSit seat supports the pelvic area in a safe and comfortable way. At the same time the warmth and soft surface of the seat ensures a pleasant sitting position.

- P6833819 - White
- P6833820 - White 50mm Raised

For Toilet Pans See Page 44

# Babyminder

The Babyminder is manufactured in the UK to the highest quality standards and combines the ultimate in safety, convenience and versatility with long-lasting, clean good looks. Installing a Babyminder changing station provides parents with a safe, convenient and hygienic changing facility in away from home locations and is now considered to be of equal importance as the provision of other essential facilities.

- Heavy-duty integral moulded hinges for strength and safety
- Easy-load integral moulded dual liner dispensers, fully encapsulated for hygiene assurance
- Soft-feel waterproof retaining strap for comfort and hygiene protection
- Heavy-duty fixings for safety assurance
- 5 year guarantee against defects in parts and workmanship



**Babyminder Vertical**



**Babyminder Horizontal**



**Babyminder Infant Safety Seat**



Baby Changing

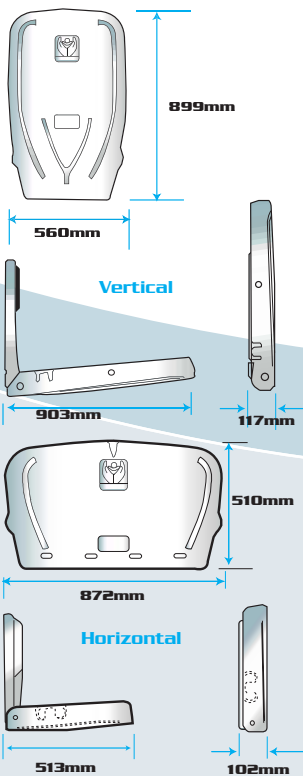

### Babyminder Horizontal

- P7120030 - White
- P7120031 - Light Granite
- P7120032 - Dark Granite

### Babyminder Vertical

- P7120033 - White
- P7120034 - Light Granite
- P7120035 - Dark Granite

### Babyminder Infant Safety Seat

- P7120037 - White
- P7120038 - Light Granite
- P7120039 - Dark Granite

### Liners

- P7120036 - (Box of 500)



Dark granite



Light granite



White

### Safegrip Straight Rails

- 1) P6857400 - 300mm Centres 2 Bracket Fixing
- 2) P6857405 - 400mm Centres 2 Bracket Fixing
- 3) P6857410 - 500mm Centres 2 Bracket Fixing
- 4) P6857415 - 600mm Centres 2 Bracket Fixing
- 5) P6857420 - 700mm Centres 2 Bracket Fixing
- 6) P6857425 - 1000mm Centres 3 Bracket Fixing
- 7) P6857430 - 1400mm Centres 3 Bracket Fixing

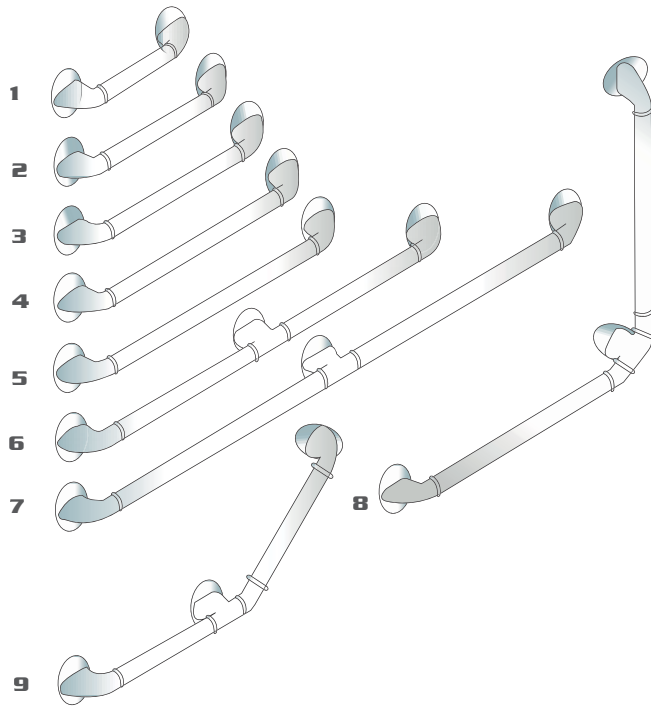

### Angled Rails

- 8) P6857435 - 600mm x 600mm x 90° 3 Bracket Fixing
- 9) P6857440 - 400mm x 400mm x 45° 3 Bracket Fixing

### Bathroom Accessories

- 11) P6857450 - Toilet Roll Holder 220mm x 75mm
- 12) P6857455 - Double Toilet Roll Holder 235mm x 75mm
- 13) P6857460 - Combined Toilet Roll Holder & 300mm Rail 2 Bracket Fixing
- 14) P6857465 - Combined Toilet Roll Holder & 500mm Rail 2 Bracket Fixing
- 15) P6857470 - Left Hand  
P6857475 - Right Hand  
Combined Toilet Roll Holder & 400mm x45° Angle Rail 2 Bracket Fixing
- 16) P6857480 - Left Hand  
P6857485 - Right Hand  
Combined Toilet Roll Holder & 600mm x90° Angle Rail 3 Bracket Fixing

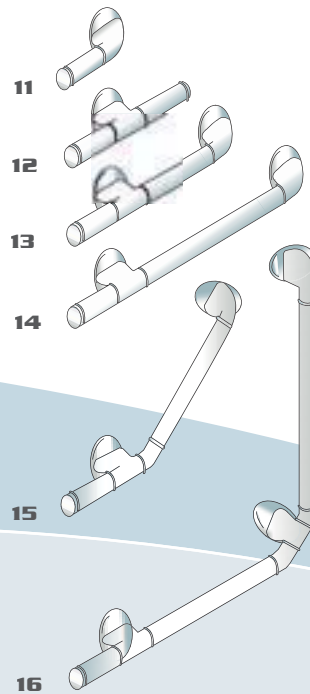

### Pressalit ABS Grabrails



Handy quick and easy to mount, they require no earthing. 32mm diameter.

- P6852501 - 150mm Centres, Finish White
- P6852511 - 300mm Centres, Finish White
- P6852521 - 450mm Centres, Finish White
- P6852531 - 600mm Centres, Finish White
- P6852541 - 600mm Centres, Finish Blue







**Titan Range**

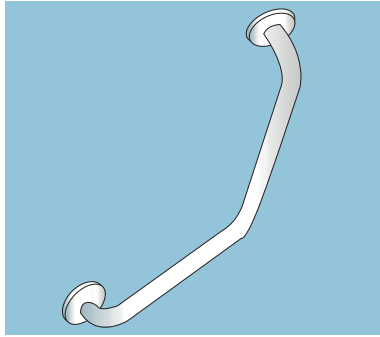

**45° ANGLED RAIL**

**2 Flanges**

P6851203 · 400mm x 400mm  
Finish White

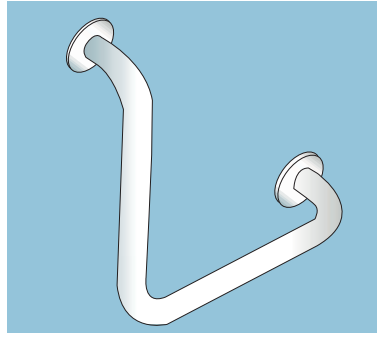

**90° ANGLED RAIL**

**2 Flanges**

P6851202 · 400mm x 400mm  
Finish White

**3 Flanges**

P6851201 · 600mm x 600mm  
Finish White

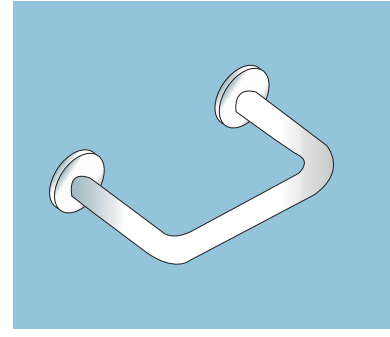

**TOILET BACKREST**

**2 Flanges**

P6850401 · 400mm x 260mm  
Finish White

P6850410 · 400mm x 260mm  
Finish Blue

P6856751 · Padded Back Support  
Finish White PVC

**Astral Range**

**45° ANGLED RAIL**

**2 Flanges**

P6857311 · 400mm x 400mm  
Finish White

**90° ANGLED RAIL**

**2 Flanges**

P6857111 · 400mm x 400mm  
Finish White

**3 Flanges**

P6857211 · 600mm x 600mm  
Finish White

P6857212 · 600mm x 600mm  
Finish Red

**TOILET BACKREST**

**2 Flanges**

P6856701 · 400mm x 260mm  
Finish White

P6856702 · 400mm x 260mm  
Finish Red

P6856751 · Padded Back Support  
Finish White PVC

**Nova Range**

**45° ANGLED RAILS**

**2 Flanges**

P6857301 · 400mm x 400mm  
Finish Polished S/Steel

**90° ANGLED RAIL**

**2 Flanges**

P6857101 · 400mm x 400mm  
Finish Polished S/Steel

**3 Flanges**

P6857201 · 600mm x 600mm  
Finish Polished S/Steel

**TOILET BACKREST**

**2 Flanges**

P6856711 · 400mm x 260mm  
Finish Polished S/Steel

P6856751 · Padded Back Support  
Finish White PVC

**Titan Range**

**'L' SHAPED RAIL**

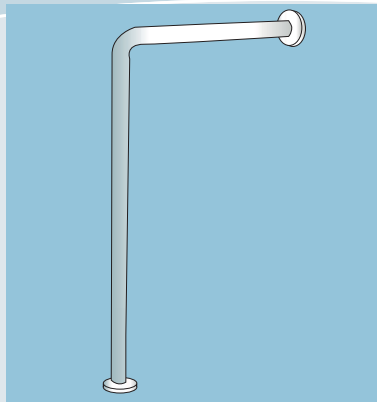

**2 Flanges**

P6850501 · 740mm x 700mm  
Finish White

**LOOP-END RAIL**

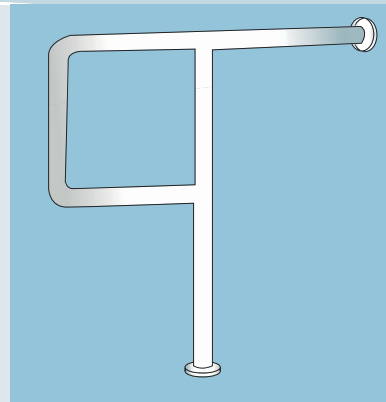

**2 Flanges**

P6850601 · 740mm x 900mm  
Finish White

### Astral Range

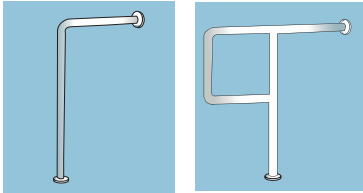

#### 'L' SHAPED RAIL

**2 Flanges**  
P6851111 - 740mm x 700mm  
Finish White

#### LOOP-END RAIL

**2 Flanges**  
P6851011 - 740mm x 900mm  
Finish White

### Nova Range

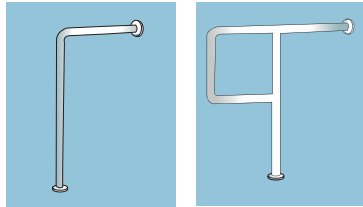

#### 'L' SHAPED RAIL

**2 Flanges**  
P6851101 - 740mm x 700mm  
Finish Polished  
Stainless Steel

#### LOOP-END RAIL

**2 Flanges**  
P6851001 - 740mm x 900mm  
Finish Polished  
Stainless Steel

#### BATH SUPPORT

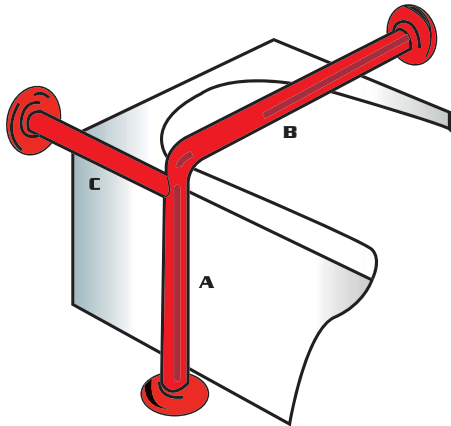

#### FLOOR TO CEILING POLE



#### FLOOR TO CEILING POLE WITH RAIL TO WALL

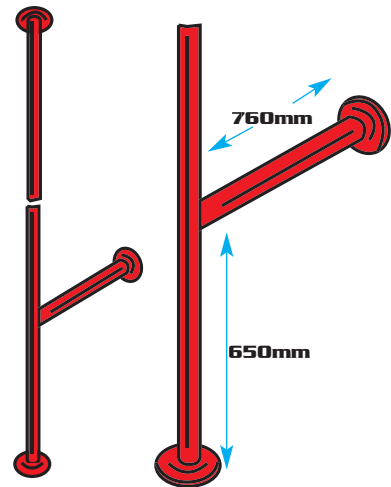

# Grab Rails

### Titan Range

**3 Flanges**  
P6851321 - A= 650mm  
B= 760mm C= 375mm  
Finish White

**2 Flanges**  
P6851301 - Length 2700mm  
One Fixed Flange One Loose Flange  
Finish White

**3 Flanges**  
P6851311 - Length 2700mm  
Two fixed flanges One Loose Flange  
Finish White

### Astral Range

**3 Flanges**  
P6851411 - A= 650mm  
B= 760mm C= 375mm  
Finish White

**2 Flanges**  
P6856211 - Length 2700mm  
One Fixed Flange One Loose Flange  
Finish White

**3 Flanges**  
P6856311 - Length 2700mm  
Two Fixed Flanges One Loose Flange  
Finish White

### Nova Range

**3 Flanges**  
P6851401 - A= 650mm  
B= 760mm C= 375mm  
Finish Polished Stainless Steel

**2 Flanges**  
P6856201 - Length 2700mm  
One Fixed Flange One Loose Flange  
Finish Polished Stainless Steel

**3 Flanges**  
P6856301 - Length 2700mm  
Two Fixed Flanges One Loose Flange  
Finish Polished Stainless Steel

### Titan Single Folding Rails



Designed for general use in limited spaced areas.  
Single bar 750mm projection

- P6851601 - Finish White
- P6851602 - Finish Red

### Titan Twin Folding Rails



Designed for general use in limited spaced areas.  
Curved twin arm

- P6851751 - 750mm Projection Finish White
- P6851701 - 1000mm Projection Finish White

### Nova Single Folding Rails



Designed for general use in limited spaced areas.  
Single bar

- P6851600 - 750mm Projection Finish Polished Stainless Steel

### Nova Twin Folding Rails



Designed for general use in limited spaced areas.  
Curved twin arm Polished stainless steel

- P6851750 - 750mm Projection Finish Polished Stainless Steel

### Single Folding Rails



Designed for general use in limited spaced areas.  
Single bar

- P6828770 - 750mm Projection Finish White

### Twin Folding Rails



Designed for general use in limited spaced areas.  
Curved twin arm

- P6828771 - 750mm Projection Finish White

## Pressalit Support Arms

The Pressalit support arms give assistance when standing, sitting or transferring to or from a toilet. The grab rail has a broad supportive surface for hands and arms.

**P6835151** - Fixed Support Arm Projection Folded 170mm

**P6835111** - Adjustable Support Arm Projection Folded 205mm

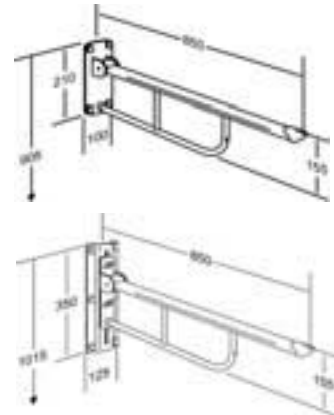

## Pressalit Support Arms with Leg

**P6835101** - Fixed Support Arm Projection Folded 135mm

**P6835001** - Adjustable Support Arm Projection Folded 145mm, Adjustment 750 to 895mm



## Pressalit Free Standing Support Arm

**P6835161** - Free Standing Support Arm

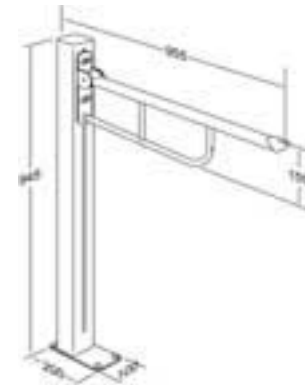

## Pressalit Toilet Support System

Complete support arm system includes:

**P6835001** - Support Arm with Leg Height Adjustable (x2)

**P6835201** - Front Rails for Support Arm

**P6835451** - Back Rest for Support Arm

**P6835501** - Side Supports for Backrest

**P6835315** - Paper Holder with Spring for Support Arm

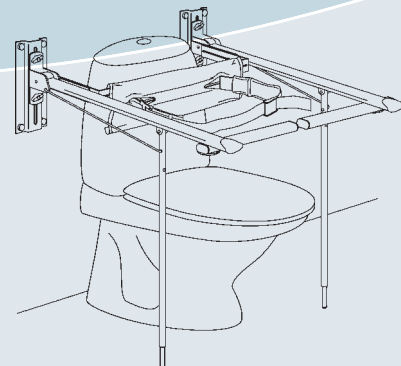

## Kitchens by Design

Phlexicare kitchens are an inspired collection of stylish and functional kitchens, that will transform any home. The perfect combination of design, colour and strength, Phlexicare will not only provide the ultimate in luxury kitchens for wheelchair users, but also with the wide choice of colours and textures for doors and worktops, help partially sighted people.

**Hartland**  
Strong rigid white carcasses  
Choice of six door colours

**Hartland Plus**  
Strong rigid coloured carcasses  
Choice of six door colours

**Arundel**  
Strong rigid white carcasses  
A wide variety of door colours and styles

**Arundel Plus**  
Strong rigid coloured carcasses  
A wide variety of door colours and styles



Our service starts on receipt of an enquiry. Our specialized staff will survey properties, offering both advice and technical backup. We will then produce a computer-aided design (CAD) and detailed quotation.



Cad Design

Phlexicare focus on special needs kitchens. We do not simply adapt a standard kitchen and claim it is suitable, we provide kitchens which are tailor-made to meet individual needs.

Once an order is received, we will keep you constantly informed as to when your kitchen and the necessary accessories will arrive.

**Good service relies on constant communication**



Phlexicare offer you not only the best in kitchen design, but also the ultimate in adjustable work surfaces, giving you a variable height adjustment of 700mm to 915mm



## Construction

These units are glued and dowelled with 6mm x 30mm dowels to make a solid 18mm box.

### CARCASE MATERIAL

- All the chipboard used is certified to the European Formaldehyde Emission Standard E1
- All panels have been tested to BS476 Part 7, surface spread of flame and achieves class 2
- All of the melamine faced 18mm particle board achieves BS5669 with a density of 680kg/m<sup>3</sup>
- The panels achieve a bending strength of 220kg/m<sup>2</sup>
- All end panels are edged on all four edges and achieve BS3962
- The thickness of the melamine edging used is 0.30 thick and protected surfaces are tested to BS3962
- The unit has a solid top. A vertical white vinyl-wrapped centre post of 30mm x 36mm is fitted to double units. In colour co-ordinated carcasses the front is edged in a matching strip.



### DRAWER SYSTEM

The drawers are a Blum Metabox construction which incorporates a drawer bottom and back made from 18mm particleboard. Drawer sides are enamelled steel and incorporate steel runners with nylon stops, which are self-closing from 60mm. All drawer boxes are manufactured in accordance with BS4875 (1985): Part 7 Level 4.

### HINGES

Units are supplied with Blum 170° hinges with a self closing action and allow four-way adjustment. The hinges meet the strength requirements of BS4875 (1985): Part 7 Level 4 and BS6222 Part 2 (1992) Level H. Hinge holes only occur where hinges are required so no unsightly hinge holes can be found on the carcass.

### PLINTH AND LEGS

2400mm length and 300mm high plinth supplied and cut according to requirement. Plastic adjustable legs with two extensions give the option to vary the base unit between 145mm and 300mm from the floor. The legs screw into flanges at the bottom of all base units and are recessed to allow for wheelchair access near units.

However, with all tall units (i.e. units that go above normal 575 carcass height) we provide separate 150mm high plinths. Also we do not recess nor provide leg extensions. This is due to the weight of the unit and we do not recommend any adjustment to this.

### FASCIAS

Doors and drawers can be adjusted for alignment purposes.

### BRACKETS

The wall hanging brackets are connected and fully adjustable. They are made from rolled steel and achieve DIN code 68840 with a loading capacity of 130kg per pair.

### HARDWOOD BACK AND VOIDS

Hardboard back is only on wall units on a white carcass. All other carcasses have 18mm colour co-ordinated backing.

500mm deep base units have 23mm void  
600mm deep base units have 60mm void

### SHELVES

All shelves are manufactured from the same materials and to the same standards as the cabinet itself. The shelf is variable between three heights and is supported by a plastic coated metal shelf.

## Hartland Range

The kitchen is the heart of every home, the place where the whole family come together. Now you can have a kitchen that caters for the whole family, the HARTLAND.

The Hartland has been specially designed and manufactured for the whole family, young or old, with all abilities catered for.

A wide choice of colours and units is available that will make any kitchen area a pleasure to use.

The Hartland Plus takes your kitchen into the height of luxury, where you can choose not only the colour of your doors, but the entire kitchen units themselves. With six vibrant colours that will enhance the whole room, it makes your kitchen the ideal focal point of your home.



Hartland Plus Green Alder with Ivory Handles



## Choice of Doors



Swiss Pear



Limed Oak

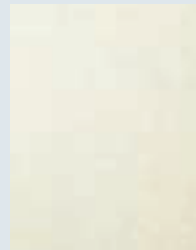

Parchment

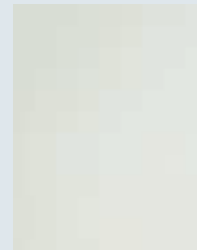

White



Blue Alder



Green Alder

**Hartland Range**

**HARTLAND**

- Strong rigid white carcases
- Choice of six door colours

**HARTLAND PLUS**

- Strong rigid coloured carcases
- Choice of six door colours



**Hartland**

COLOUR	COLOUR OF CARCASE	PVC EDGING	LIGHTING PELMET/ CORNICHE COLOUR	STYLE L/P CORNICHE
Swiss Pear	White	Swiss Pear	Swiss Pear	Traditional
Green Alder	White	Swiss Pear	Swiss Pear	Traditional
Blue Alder	White	Swiss Pear	Swiss Pear	Traditional
Parchment	White	Swiss Pear	Swiss Pear	Traditional
Limed Oak	White	Limed Oak	Limed Oak	Traditional
White Ash	White	White/Grey Duo	White Ash	Traditional

**Hartland Plus**

COLOUR	COLOUR OF CARCASE	PVC EDGING	LIGHTING PELMET/ CORNICHE COLOUR	STYLE L/P CORNICHE
Swiss Pear	Swiss Pear	Swiss Pear	Swiss Pear	Traditional
Green Alder	Swiss Pear	Swiss Pear	Swiss Pear	Traditional
Blue Alder	Swiss Pear	Swiss Pear	Swiss Pear	Traditional
Parchment	Swiss Pear	Swiss Pear	Swiss Pear	Traditional
Limed Oak	Limed Oak	Limed Oak	Limed Oak	Traditional
White Ash	White	White/Grey Duo	White Ash	Traditional

Full CAD Design Service Available on Request

## Arundel Range

When choosing a kitchen you demand a choice, a choice of colours, styles and designs. The Arundel gives you that choice to your kitchen, the kitchen of your dreams.

With a variety of door styles and colours, it will transform your kitchen area into that luxury kitchen you always wanted.

The Arundel has been designed and manufactured with you and your family in mind, with all abilities catered for.

The Arundel Plus is the height of luxury, where the entire kitchen can be colour co-ordinated to match into any colour scheme you have in mind. There is a wide range of colours and door styles to choose from that will transform your kitchen into your ideal kitchen.



## Choice of Doors



Scope Calvados



Swiss Pear



Carisbrooke



Scope Maple

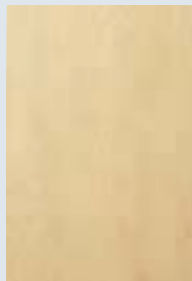

Annan



Solway



**Arundel Range**

**ARUNDEL**

- Strong rigid white carcasses
- A wide variety of door colours and styles

**ARUNDEL PLUS**

- Strong rigid coloured carcasses
- A wide variety of door colours and styles



**Arundel**

COLOUR	COLOUR OF CARCASE	LIGHTING PELMET/ CORNICE COLOUR	STYLE L/P CORNICE
Solway White	White	White Ash	Traditional
Providence Swiss Pear	White	Swiss Pear	Traditional
Carisbrooke Light Oak	White	Light Oak	Traditional
Annan	White	Birch	Modern
Scope Maple	White	Maple	Modern
Scope Calvados	White	Medium Apple	Modern

**Arundel Plus**













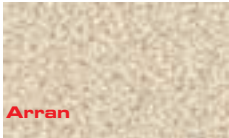

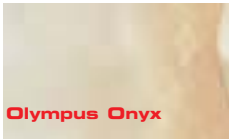

COLOUR	COLOUR OF CARCASE	LIGHTING PELMET/ CORNICE COLOUR	STYLE L/P CORNICE
Solway White	White	White Ash	Traditional
Providence Swiss Pear	Swiss Pear	Swiss Pear	Traditional
Carisbrooke Light Oak	Light Oak	Light Oak	Traditional
Annan	Natural Birch	Birch	Modern
Scope Maple	Maple	Maple	Modern
Scope Calvados	Medium Apple	Medium Apple	Modern

Full CAD Design Service Available on Request

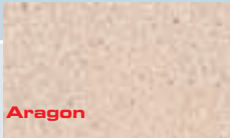

## Worktops

Available in eighteen different colours, 3000mm long 30 or 40mm thick and have been carefully selected to offer the best possible choice to combine with our fascia and carcass colours.

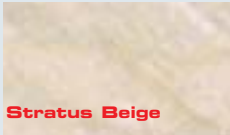
	30MM	40MM		30MM	40MM
 <b>Adriatic Marble</b>	S3270124	S3270224	 <b>Dapple Slate</b>	S3270131	S3270231
 <b>Arran</b>	S3270120	S3270220	 <b>Moss Green</b>	S3270132	S3270232
 <b>Olympus Onyx</b>	S3270128	N/A	 <b>Chiltern Beech</b>	S3270101	N/A
 <b>Stratus Grey</b>	S3270123	S3270223	 <b>Windsor Oak</b>	S3270125	S3270225
 <b>Martian</b>	S3270005	S3270228	 <b>Autumn Sand</b>	S3270133	N/A
 <b>Rossini Granite</b>	S3270127	S3270227	 <b>Jupurana</b>	S3270134	S3270234
 <b>Pacific Blue</b>	S3270129	S3270229	 <b>Maple</b>	S3270135	S3270235
 <b>Coral Green</b>	S3270130	S3270230	 <b>Aragon</b>	S3270136	S3270236
 <b>White</b>	S3270121	S.32702.21	 <b>Stratus Beige</b>	S3270126	S3270226

## Worktop Joints Satin Finish

### CORNER

S3272001 - 30mm  
S3272003 - 40mm

### IN LINE STRIP

S3272002 - 30mm  
S3272005 - 40mm

### END STRIP

S3272011 - 30mm  
S3272004 - 40mm

## Cupboard Handles

A wide selection of handles to complement the stunning effect



Chrome Knob

Grey Ceramic Knob

Beige Ceramic Knob

White Ceramic Knob

Oak Knob



Large Stainless Steel Handle

Medium Stainless Steel Handle



Limed Oak 'D' Handle

Light Oak 'D' Handle

Chrome 'D' Handle



Blue 'D' Handle

Red 'D' Handle

Brown 'D' Handle

Grey 'D' Handle

Ivory 'D' Handle

White 'D' Handle

## Coding System and the Units



The following pages feature diagrams and information on our Phlexicare kitchen units.

We have adopted a coding system so that it is possible to specify a unit type, the range and the handing where necessary.

The picture shows a 400 wide right-hand base unit 600 deep in Hartland.

You would find the code for a 400 base unit that is 600 deep is P19046... \_ \_

The last 2 numbers are blank.

The last number denotes the

range:-

- 1 = Hartland
- 2 = Hartland Plus
- 3 = Arundel
- 4 = Arundel Plus

The penultimate number denotes the handing:-

- 0 = Unhanded (Already inserted)
- 7 = Left Hand Hung
- 9 = Right Hand Hung

Therefore the code would be P1904691

Right hand Hartland range.

If, however, the unit was 400 wide 600 deep Left-hand base unit in Arundel Plus the code would be. P1904674

Left hand Arundel Plus.

**Kitchen Units**

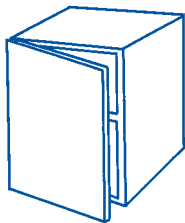

**Single Base Unit**

Width	500	Depth	600	Depth	300
300	P19035		P19036		
400	P19045		P19046		
500	P19055		P19056		
600	P19065		P19066		

Height 575

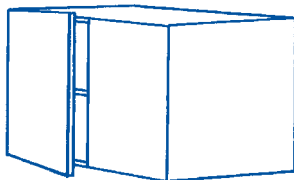

**Double Base Unit**

Width	500	Depth	600	Depth	800
800	P190850		P190860		
1000	P190050		P190060		

Height 575

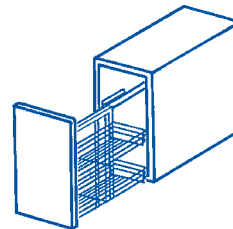

**Pull Out Unit with Basket**

Width	300
Depth	600

P191360

Height 575

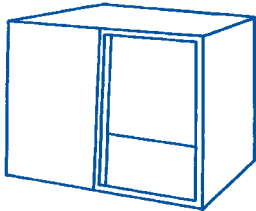

**Corner Base Unit**

Width	500	Depth	600	Depth	800
800	P19185		P19186		
1000	P19105		P19116		

Height 575

One Door Plus One Blank End

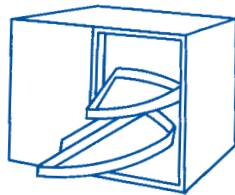

**Corner Base Unit with Swivel Tray**

Width	1000
Depth	600
Height	575

P19106

One Door Plus One Blank End

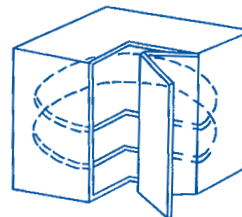

**L-Shape Corner Base Unit**

Width	900 x 900
Depth	600
Height	575

P19196 - Base Unit with Carousel

P19096 - Base Unit without Carousel

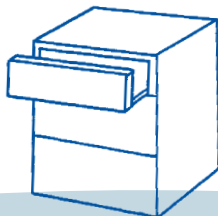

**3 Drawer Unit**

Width	500	Depth	600	Depth	400
400	P191450		P191460		
500	P191550		P191560		
600	P191650		P191660		

Height 575

400mm wide unit unavailable in Arundel and Arundel Plus Top and Middle Drawers 140mm Bottom Drawer 283mm

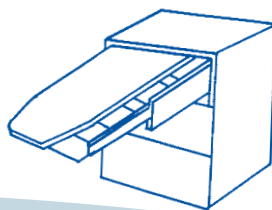

**3 Drawer Unit with Pullout Ironing Board**

Width	500
Depth	600
Height	575

P195560

Top and Middle Drawers 140mm Bottom Drawer 283mm

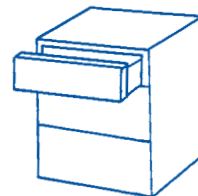

**3 Drawer Unit with Pullout Table**

Width	500
Depth	600
Height	575

P193560

Top and Middle Drawers 140mm Bottom Drawer 283mm

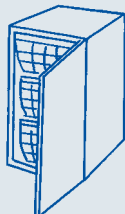

**3 Tray Unit**

Width	500
Depth	600
Height	575

P19156

One Door with Pullout Wire Trays

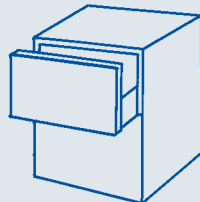

**2 Drawer Unit**

Width	500	Depth	600	Depth	400
400	P192450		P192460		
500	P192550		P192560		
600	P192650		P192660		

Height 575

400mm wide unit unavailable in Arundel and Arundel Plus. Drawers 283mm Deep



**Mobile Trolley Unit**

Height	650
Width	500
Depth	500

P190750

Special Needs Kitchens

**Kitchen Units**

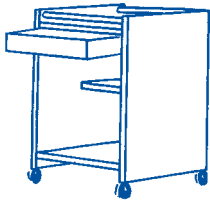

**Mobile Trolley Unit**  
with Cutlery Tray

Height 650  
Width 500  
Depth 500

P191750\_

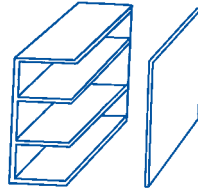

**Compensating Base Unit**

Width 300	500 Depth	600 Depth
	P192750_	P192760_

Height 575

Side panels are screwed and can be removed to adjust width



**Open End Base Unit**

Width 300	500 Depth	600 Depth
	P19135_	P19136_

Height 575

**Open End Wall Unit**

Wide 300  
Depth 300  
Height 575

P.16333\_

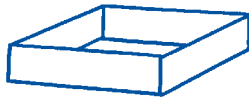

**Worktop Support Plinth**

Specify Width (upto 1500mm)  
Per 100mm

P193750\_ - Depth 500  
P193760\_ - Depth 600

Requires worktop support brackets  
P6910030

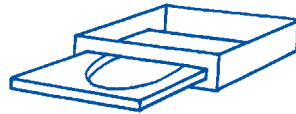

**Worktop Plinth with Pull-Out Chopping Board**

Width 500	500 Depth	600 Depth
	P195750_	P195760_

Requires worktop support brackets  
P6910030



**Worktop Plinth with Pull-Out Shelf**

Width 500	500 Depth	600 Depth
	P196750_	P196760_

Requires worktop support brackets  
P6910030



**Worktop Plinth for Ropox Unit**

Specify Width in 100mm intervals  
(upto 2400mm)

P194760\_

Requires returns for Ropox units  
Also use between units where support is not required



**Infill Panels**

Base and Wall Filler  
Width Per 100  
Height 575

P160000\_

**Tall Filler**

Width Per 100  
Height 1975

P181540\_

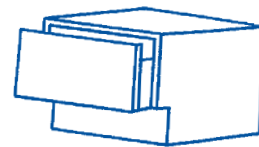

**Appliance Mounting Unit with Drawer**

Height 450  
Width 600  
Depth 600

P185000\_

To support cooker or microwave  
Drawer 283mm

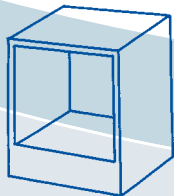

**Under Microwave Housing Unit**

Width 600  
Depth 600  
Height 575

P185010\_

Please specify appliance model

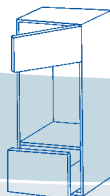

**1400 Single Oven Housing Unit**

Height 1415  
Width 600  
Depth 600

P18502\_

Please specify appliance model 150mm plinth height required  
Bottom Drawer 355mm Top Drawer 283mm

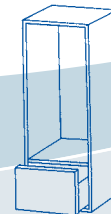

**1400 Double Oven Fridge Unit**

Height 1415  
Width 600  
Depth 600

P185030\_

Please specify appliance model 150mm plinth height required  
Bottom Drawer 355mm

**Kitchen Units**

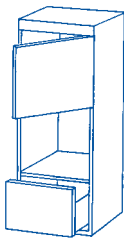

**Low Single Oven Housing with Large Drawer**

Height 1975  
Width 600  
Depth 600

P18504 \_ \_

Please specify appliance model  
150mm plinth height required  
Bottom Drawer 355mm Door 715mm  
Fixed Panel at Top 140mm

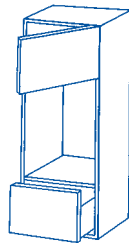

**Low Double Oven Housing with Large Drawer**

Height 1975  
Width 600  
Depth 600

P18505 \_ \_

Please specify appliance model  
150mm plinth height required  
Bottom Drawer 355mm  
Door 570mm

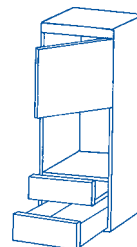

**Low Single Oven Housing with Drawer and Shelf**

Height 1975  
Width 600  
Depth 600

P18506 \_ \_

Please specify appliance model  
150mm plinth height required  
Bottom Drawer 175mm  
Door 715mm, Pullout Shelf 140mm  
Fixed Panel at Top 140mm

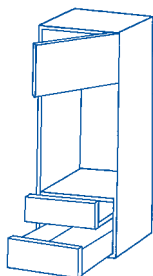

**Low Double Oven Housing with Drawer and Shelf**

Height 1975  
Width 600  
Depth 600

P18507 \_ \_

Please specify appliance model  
150mm plinth height required  
Bottom Drawer 175mm  
Pullout Shelf 140mm  
Door 715mm

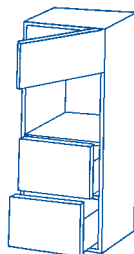

**High Single Oven Housing with 2 Large Drawers**

Height 1975  
Width 600  
Depth 600

P18508 \_ \_

Please specify appliance model  
150mm plinth height required  
Bottom Drawers 355mm  
Door 495mm

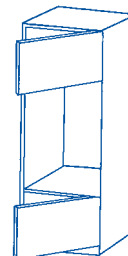

**High Double Oven Housing with Door**

Height 1975  
Width 600  
Depth 600

P18509 \_ \_

Please specify appliance model  
150mm plinth height required  
Bottom Door 570mm  
Top Door 355mm

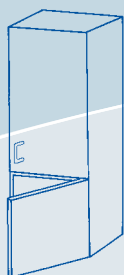

**Larder Unit**

Height 1975  
Width 500  
Depth 600

P18510 \_ \_

150mm plinth height required  
Top Door 1245mm  
Bottom Door 570mm

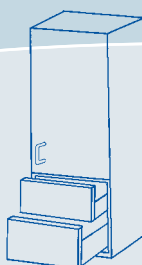

**Larder Unit with 2 Draws Under**

Height 1975  
Width 500  
Depth 600

P18511 \_ \_

150mm plinth height required  
Bottom Drawers 283mm  
Door 1245mm

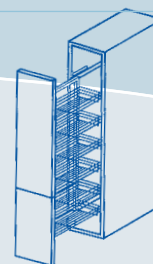

**Pull Out Larder Unit**

Height 1975  
Width 300  
Width 500  
Depth 600

150mm plinth height required

P185140 \_ \_  
P185150 \_ \_

Special Needs Kitchens



**Kitchen Units**

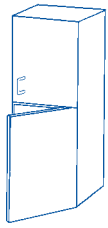

**Integrated Fridge Freezer Unit**

Height 1975  
Width 600  
Depth 600

P18513\_ \_

Please specify appliance model  
150mm plinth height required



**Support Panel**

P185160\_ - Base End Panel  
900 High 600 Deep  
P185170\_ - Wall End Panel  
575 High 300 Deep  
P185180\_ - Tall End Panel  
1975 High 600 Deep

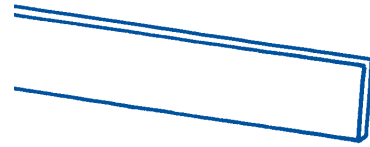

**Kickboard Plinth**

P160010\_ - Length 2400 Height 300  
Height Cut to Suit  
Requirements  
P160020\_ - Edging Strip  
P160040\_ - Flyover Shelf  
Specify Length Per  
100mm up to 2400mm

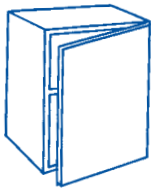

**Single Wall Unit**

Width	575	Height
300	P16033	_ _
400	P16043	_ _
500	P16053	_ _
600	P16063	_ _

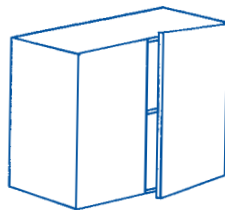

**Double Wall Unit**

Width	575	Height
800	P160830	_ _
1000	P160030	_ _



**Single Open Wall Unit**

Width	575	Height
300	P16133.0	_ _
400	P16143.0	_ _
500	P16153.0	_ _
600	P16163.0	_ _

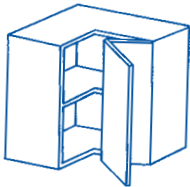

**L Shape Corner Wall Unit**

Width 600x600  
Height 575

P16266\_ \_

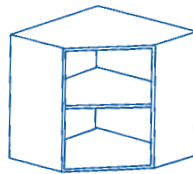

**Open Corner Wall Unit**

Width 600x600  
Height 575

P16066\_ \_

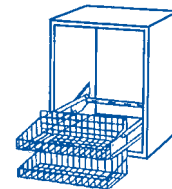

**Open Wall Unit with Pull Down Basket**

Width 500  
Height 575

P164530\_

**Corner Wall Unit with Door**

Width 600x600  
Height 575

P16166\_ \_

**Wall Unit with Door and Pull Down Basket**

P16253\_ \_ - Width 500 Height 575  
with Hinge 90°

P16353\_ \_ - Width 500 Height 575  
with Hinge 170°

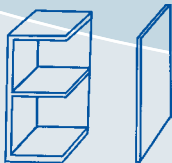

**Wall Compensating Unit**

Width 300  
Height 575

P162330\_

Side panels are screwed and can be removed to adjust width

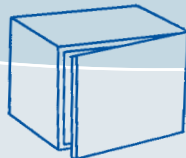

**Top Box**

Width	300	Height
500	P16025	_ _
600	P16125	_ _
1000	P16225	_ _

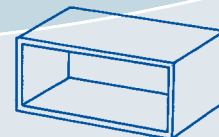

**Midway Unit**

Height	200	
Depth	125	
Width	500	P163250_
Width	1000	P163200_

**Appliances**



**SIDE HUNG SINGLE OVEN**

- P1800001 - White L/H
- P1800002 - White R/H

- With Non-tilt Shelves
- P1800020 - White L/H
  - P1800021 - White R/H
  - P1800004 - S/Steel L/H
  - P1800005 - S/Steel R/H



**FRONT CONTROL HOBBS**

- P1800008 - White Electric
- P1800009 - S/Steel Electric
- P1800010 - White Gas
- P1800011 - S/Steel Gas
- P1800012 - White Ceramic
- P1800013 - S/Steel Ceramic
- P1800014 - Induction Hob



**SIDE HUNG DOUBLE OVEN**

- P1800006 - S/Steel L/H
  - P1800007 - S/Steel R/H
- with Non-tilt Shelves
- P1800022 - White L/H
  - P1800023 - White R/H



**AUTOMATIC COOKER HOOD**

- P6893301 - White Hood
- P6893311 - Ducting Kit



**COMPACT WASHING MACHINE**

- P1800050 - 495 Wide 610 High 515 Deep



**COMPACT DISHWASHER**

- P1800052 - 450 Wide 460 High 480 Deep



**COMPACT FREEZER**

- P1800054 - 525 Wide 520 High 587 Deep



**30CM 2 BURNER GAS HOB FRONT CONTROLS**

- P1800055 - Front Controls Stainless Steel



**COMPACT CONDENSER TUMBLE DRYER**

- P1800051 - 595 Wide 688 High 420 Deep



**COMPACT FRIDGE**

- P1800053 - 525 Wide 520 High 587 Deep



**30CM 2 BURNER ELECTRIC HOB FRONT CONTROLS**

- P1800056 - Front Controls Stainless Steel

## Kitchen Sinks



940 x 490mm

### ONE TAPHOLE SHALLOW BOWL S/STEEL SINK

**P1800031** - One taphole



940 x 490mm

### TWO TAPHOLE SHALLOW BOWL S/STEEL SINK

**P6882011** - L/H Drainer Two Taphole

**P6882001** - R/H Drainer Two Taphole

### SINK WASTES AND ROPOX ACCESSORIES

**S2361001** - 38mm Waste and Overflow

**S2361011** - Ropox 32mm Waste and Overflow for Flexible Plumbing Kits

**P6843420** - Flexible Plumbing Kit

**S2372001** - Bottle Trap

## Ropox Variable Height Kitchen Frames

The Ropox variable height kitchen system is ideal for not only home use, but also in sheltered housing schemes where kitchen facilities are shared, or as an assessment kitchen in occupational therapy departments. Adjustability in height is achieved manually by means of a simple detachable winding handle, or electronically at the touch of a button.

The adjustable worktop assembly for inset sinks and cooking hobs, are made to a standard depth of 580mm to support a 600mm worktop. Two standard widths -1000mm and 1500mm are available, but special widths can be manufactured up to 3000mm. Height is variable from 650mm to 910mm by means of a cranked handle or an electrical operation from a 24v motor. The unit can be free-standing or wall-mounted.



## RT-Model for Worktops

Wall-mounted or free-standing frames, either electronically or manually operated for the height adjustment of worktops only. The RT model can be manufactured in any length from 600mm - 3000mm and has an additional telescopic central leg on all frames longer than 2000mm to guarantee stability. Electrical height adjustment is made by means of a single motor, or by a very quiet parallel steering system. The range of height adjustment for both the electrical and manual frame is between 680mm and 980mm from the floor.

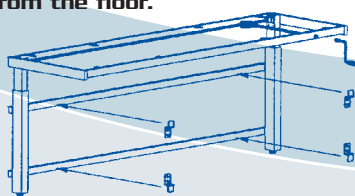

**RT Wall-mounted Manual**

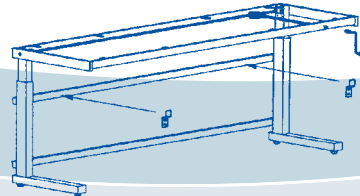

**RT Free-Standing Manual**

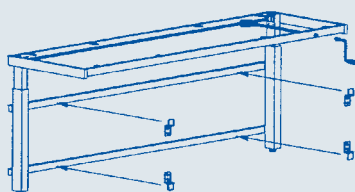

**RT Wall-mounted Electrical**

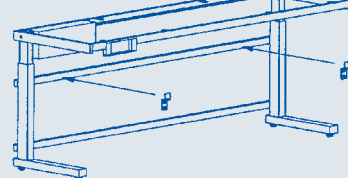

**RT Free-Standing Electrical**



## Wall-mounted Ropox Frame

	Manual		Electric		
	L/H adjustable	R/H adjustable	L/H adjustable	R/H adjustable	
1000mm	P1810001	P1810002	P1810003	P1810004	
1500mm	P1810005	P1810006	P1810007	P1810008	

For electric Ropox frames please ensure that you order a safety stop.

1000mm P1820090  
1500mm P1820091

## Floor-mounted Ropox Frame

	Manual		Electric		
	L/H adjustable	R/H adjustable	L/H adjustable	R/H adjustable	
1000mm	P18200.01	P18200.02	P18200.03	P18200.04	
1500mm	P18200.05	P18200.06	P18200.07	P18200.08	

For electric Ropox frames please ensure that you order a safety stop.

1000mm P1820090  
1500mm P1820091

## Further Ropox Models



Wall unit vertical and forward adjustment



Worktop and base unit adjustment



Worktop, base and wall unit adjustment

The following diagrams illustrate other Ropox adjustable frames available from Phlexicare. Please contact your nearest Branch for details.



Built-in appliance adjustment

For the Full Range of N&C Phlexicare Products Request Your Copy of Our Phlexicare Catalogue





# N&C

**Moderna**

Technical Professional Products  
Surveyed, Supplied and Serviced Nationwide



Due to the technical nature of these products, it is recommended that a full assessment is made of the user, Please contact our Mobility department

Mobility

Access

Lifting and handling





For more information go to [www.barbourproductsearch.info](http://www.barbourproductsearch.info)

# N&C

**Moderna**

Technical Professional Products  
Surveyed, Supplied and Serviced Nationwide



Hoist and Sling  
assessments,  
Please contact our  
Moving and Handling  
department



Hoisting Systems

Recliner Chairs

Nursing Beds

# N&C

**Building Materials**



## General Sanitary

**In addition to our N&C Olympus brand of sanitaryware Products we are able to offer a large selection of leading manufacturers and brands from within the sanitaryware market which are available from stock:**

**Ideal Standard, Armitage Shanks, Trevi, Roca, Triton and Mira to name a few.**

**The following section details these products in full.**





everything in bathrooms everything Roca



**Roca**

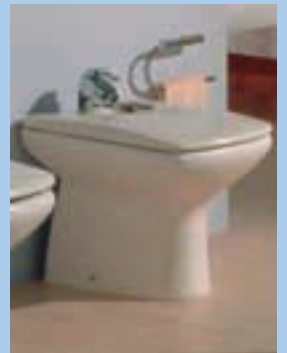

## Roca Baths

AS A STOCKIST AND MAJOR DISTRIBUTOR OF ROCA STEEL AND CAST IRON BATHS, THEIR EXTENSIVE RANGE IS AVAILABLE FROM THE N&C GROUP OF COMPANIES.

THE BATHS DEPICTED ARE STOCKED IN ALL SIZES LISTED AND IN THE CASE OF STEEL BATHS COME COMPLETE WITH BOLT ON METAL LEGSETS.

STEEL BATHS CAN BE ORDERED WITH B.S.S TUBULAR CRADLES IF REQUIRED.

ALL STOCKED BATHS ARE WHITE WITH TWO TAPHOLES (OTHER VARIATIONS AVAILABLE TO ORDER).

### Contessa 1.6mm Sheet Steel Bath

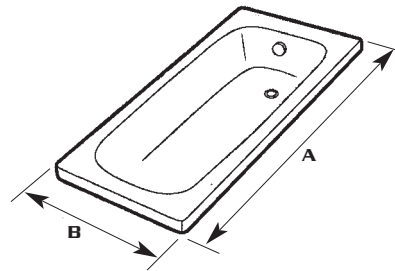

A	B
1700	700
1600	700
1500	700

- S2000001 - 1700 X 700mm Plain no Antislip
- S2000002 - 1600 X 700mm Plain no Antislip
- S2000003 - 1500 X 700mm Plain no Antislip

- S2003011 - 1700 X 700mm Plain with Antislip
- S2003005 - 1600 X 700mm Plain with Antislip
- S2003001 - 1500 X 700mm Plain with Antislip

### Carla 1.6mm Sheet Steel Bath

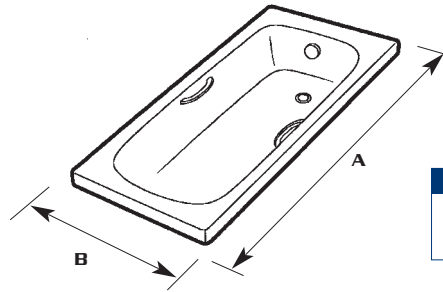

A	B
1700	700
1600	700
1500	700

- S2000004 - 1700 X 700mm Twingrip no Antislip. C.P Grips
- S2000006 - 1600 X 700mm Twingrip no Antislip. C.P Grips
- S2000005 - 1500 X 700mm Twingrip no Antislip. C.P Grips

- S2000151 - 1700 X 700mm Twingrip with Antislip. C.P Grips
- S2000154 - 1600 X 700mm Twingrip with Antislip. C.P Grips
- S2000153 - 1500 X 700mm Twingrip with Antislip. C.P Grips

### Corner 1.6mm Sheet Steel Bath

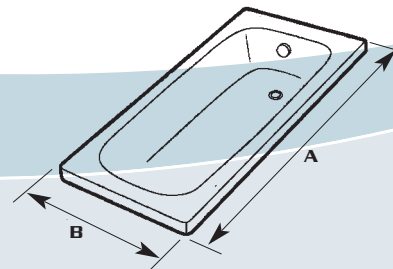

A	B
1700	700
1600	700
1500	700

- S2000007 - 1700 X 700mm Plain No Antislip with Right Hand Corner Tapholes

- S2000008 - 1700 X 700mm Plain No Antislip with Left Hand Corner Tapholes

For Waste and Traps See Page 228-229

Roca Steel Baths

**Swing 3.0mm Sheet Luxury Steel Bath**

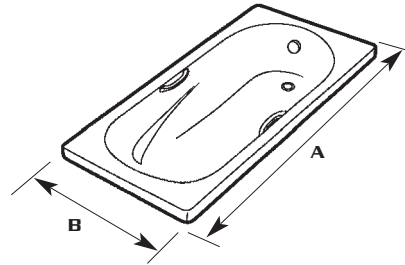

A	B
1700	700
1800	800

S6100000 - 1700 X 700mm Luxury Steel Twingrip Bath with Antislip and C.P. Grips

S6100001 - 1800 X 800mm Luxury Steel Twingrip Bath with Antislip and C.P. Grips

Supplied Complete with Adjustable Metal Legset

**Continental Cast Iron Bath**

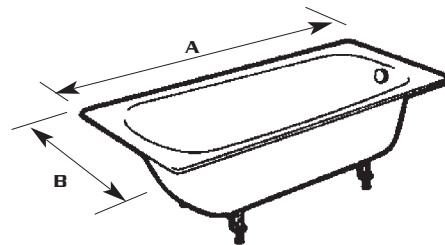

A	B
1700	700

S2000155 - 1700 X 700mm Plain Bath no Antislip

**Martina Cast Iron Bath**

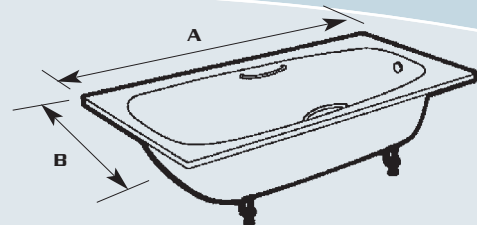

A	B
1700	700

S2000156 - 1700 X 700mm Twingrip Bath with Antislip and C.P. Grips

For Waste and Traps See Page 228-229



**Enamelled HardBoard Bath Panel**



S2011001 - Front Panel 1830mm Black  
 S2011002 - Front Panel 1830mm White

S2011011 - End Panel 760mm Black  
 S2011012 - End Panel 760mm White

S2011501 - Chrome Angle Strip for above



**Broadgate Acrylic Bath Panel**



S2000161 - Front Panel 1700mm White

S2000171 - End Panel 700mm White supplied with angle strip



**Solid Wood Effect Bath Panel**



S7001080 - Front Panel 1700mm Maple  
 S7001082 - End Panel 700mm Maple

S7001081 - Front Panel 1700mm Pine  
 S7001083 - End Panel 700mm Pine

S7001092 - Front Panel 1700mm Mahogany  
 S7001093 - End Panel 700mm Mahogany

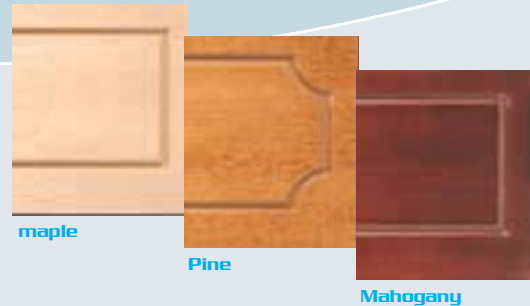

maple

Pine

Mahogany

For Athens Luxury Acrylic Panels See Page 16

**Olympus B.S.5 White Ware**

N&C Olympus B.S.5 Sanitaryware is manufactured to the same high standards which apply to other Olympus brand products shown within this catalogue.

Our B.S.5 ware is ideally suited to the replacement market due to the large footplate on both W.C and pedestal. Thus covering existing footprint on floor.

**H.O W.C. Pan**

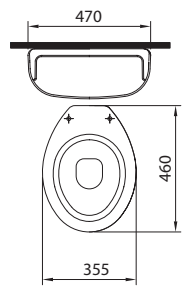
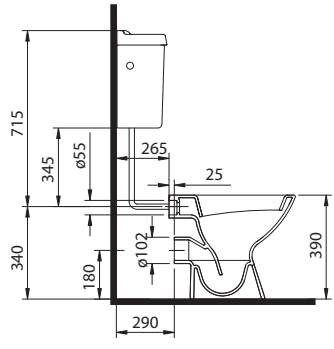

**S7006010 - OL56 H.O. W.C. Pan**

**'P' Trap W.C. Pan**

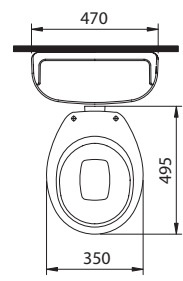
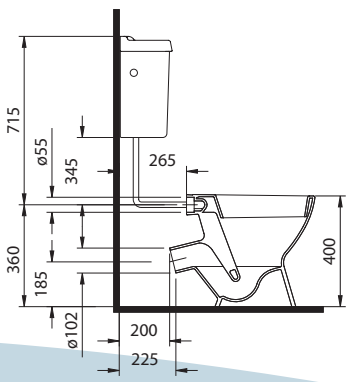

**S7006011 - OL57 'P' Trap W.C. Pan**

**'S' trap W.C. Pan**

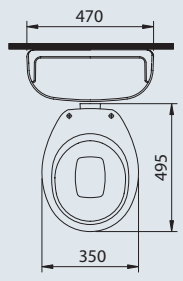
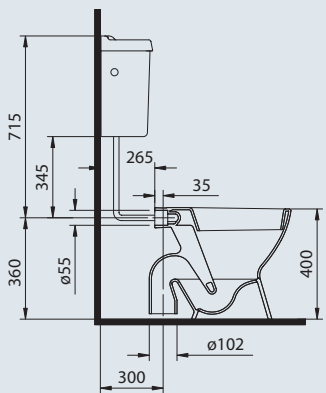

**S7006012 - OL58 'S' Trap W.C. Pan**

For Toilet Seats See Page 153-154

**Low Level Cistern (S.I.S.O)**

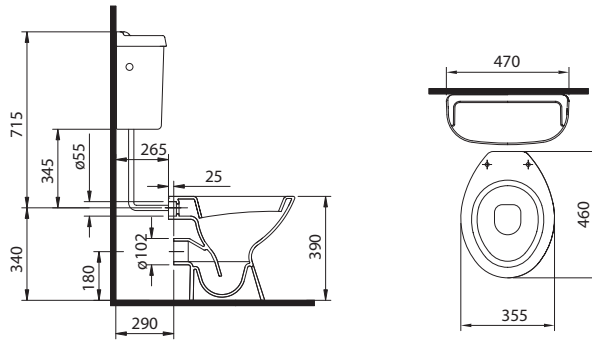

**S7006013 - OL59 Low Level Cistern Shell (S.I.S.O)**  
**S7006014 - Fitting Pack for above with C.P. Front Lever.**  
 (Internal/External Overflow)

**Basin and Pedestal**

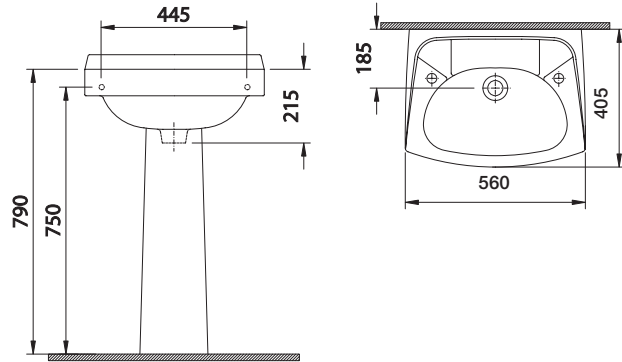

**S7006015 - OL60 560x405mm Basin Tapholes 2**  
 (For Towel Rail brackets to wall fix this Basin see page 142)



**S7006016 - OL61 Pedestal**

For Toilet Seats See Page 153-154

**Contractors Commercial Sanitaryware**

**H.O. W.C. PAN**

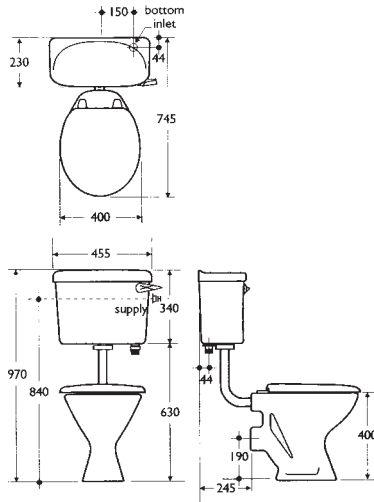

S2000191 - H.O. W.C. Pan

**'P' TRAP W.C. PAN**

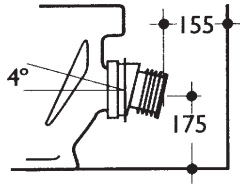

S2000195 - 'P' Trap W.C. Pan

**'S' TRAP W.C. PAN**

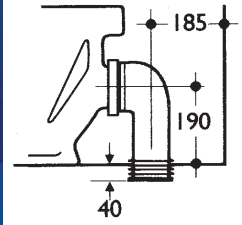

S2000196 - 'S' Trap W.C. Pan

**BASIN AND PEDESTAL**



**LOW LEVEL CISTERNS AND FITTINGS**



S2000192 - Low Level Cistern and Fittings C.P. Lever S.I.S.O (Internal Overflow)

S2000197 - Low Level Cistern and Fittings C.P. Lever B.I.B.O (Internal Overflow)

**LOW LEVEL CISTERNS AND FITTINGS WITH SCREW DOWN LID**



S2000198 - Low Level Cistern and Fittings C.P. Lever S.I.S.O with Screw Down Lid (Internal Overflow)

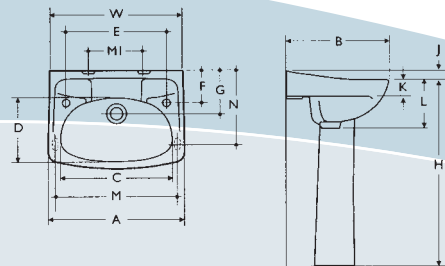

A	B	C	D	E	F	G	H	J	K	L	M	MI	N	W
560	410	460	270	405	140	180	800	45	70	200	500	220	305	525

S2000193 - 560x 405mm Basin Two Tap Holes  
S2000194 - Pedestal

(for Towel Rail Brackets To wall Fix This Basin See Page 141)

S2100151 - Overlap Joint (to use above basin in range form if required)



For Toilet Seats See Page 153-154

## Contractors Commercial Sanitaryware



S2063001 - Towel Rail Brackets Painted Iron  
Wall to Centre of Stud 305mm

S2063002 - Towel Rail Brackets White Coated  
Wall to Centre of Stud 305mm

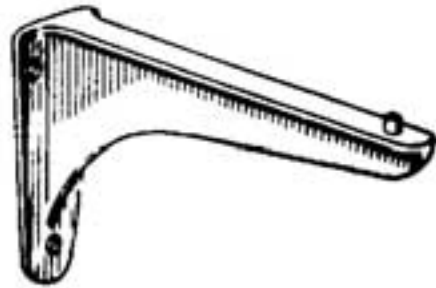

S2063011 - Screw To Wall Bracket Painted Iron  
Wall to Centre of Stud 305mm

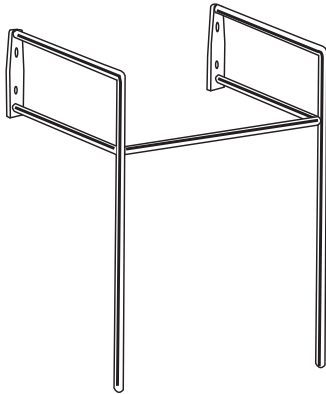

S2063501 - Chrome Floor Fixing Basin Stand



S2063511 - Leg And Bearer Support 305mm  
Stud, 735mm High Finish Painted Iron

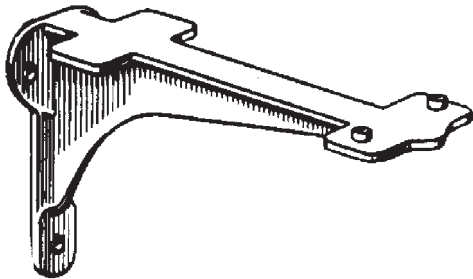

S2063021 - Twin Pinned Centre Bracket  
Screw to Wall 305mm Stud,  
Painted Iron

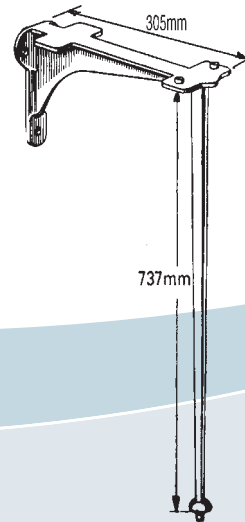

S2063521 - Leg And Bearer Support Twin Pinned  
Centre Bracket 305mm Stud,  
Finish Painted Iron



S2063031 - Build In End Bracket 305mm Stud Painted Iron



S2063041 - Build In Centre Bracket 305mm Stud Twin Pinned Painted Iron

Basin Brackets and Stands



## Contractors Commercial Sanitaryware

### TURNED TRAP W.C. PAN

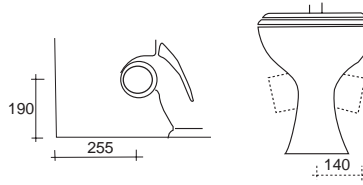

**S2174021** - Left Hand Turned 'P' Trap W.C. Pan

**S2174031** - Right Hand Turned 'P' Trap W.C. Pan

### TWO PIECE W.C. PAN

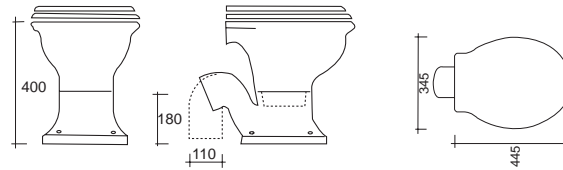

**S2174501** - Two Piece 'P' Trap W.C. Pan

**S2174511** - Two Piece 'S' Trap W.C. Pan

### CHILDRENS W.C. PAN

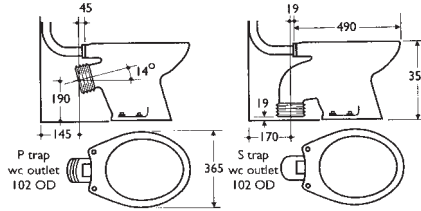

**S2175001** - 355mm Childrens W.C. Pan 'P' Trap

**S2175011** - 355mm Childrens W.C. Pan 'S' Trap

### CHILDRENS W.C. PAN

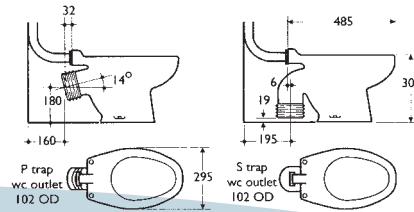

**S2175021** - 305mm Infant W.C. Pan 'P' Trap

**S2175031** - 305mm Infant W.C. Pan 'S' Trap

### BACK TO WALL W.C. PAN

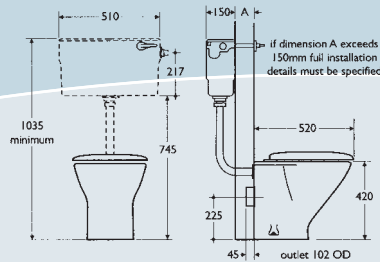

**S2158001** - Contour Rimless H.O. Back To Wall W.C. Pan

**S2158011** - White Seat and Cover to Suit Above with Chrome Hinges and S/Steel Rod

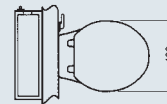

### WALL HUNG W.C. PAN

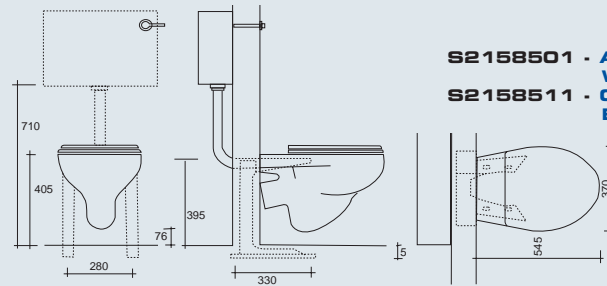

**S2158501** - Avon Wall Hung W.C. Pan 'P' Trap

**S2158511** - C.I. Brackets and Bolts For Above

For Cisterns See Page 143-144 For Toilet Seats See Page 153-154

## Contractors Commercial Sanitaryware

### Derby Low Level Cistern

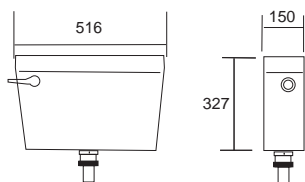

- S7000001** - Derby Low Level Economy Plastic Cistern and Fittings C.P. Lever S.I.S.O Finish White
- S7000002** - Derby Low Level Economy Plastic Cistern and Fittings C.P. Lever S.I.S.O Finish Black

### TRISHELL LOW LEVEL CISTERN

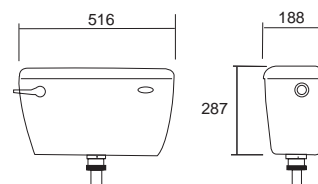

- S2163501** - Trishell Low Level Heavy Duty Plastic Cistern and Fittings C.P. Lever S.I.S.O Finish White
- S2163502** - Trishell Low Level Heavy Duty Plastic Cistern and Fittings C.P. Lever S.I.S.O Finish Black
- S2163503** - Trishell Low Level Heavy Duty Plastic Cistern and Fittings C.P. Lever B.I.B.O Finish White
- S2163504** - Trishell Low Level Heavy Duty Plastic Cistern and Fittings C.P. Lever B.I.B.O Finish Black

### TRISHELL HIGH LEVEL CISTERN

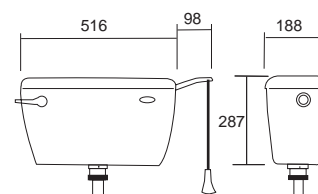

- S2171501** - Trishell High Level Heavy Duty Plastic Cistern and Fittings with Chain Pull S.I.S.O Finish Black
- S2171502** - Trishell High Level Heavy Duty Plastic Cistern and Fittings with Chain Pull S.I.S.O Finish White

### TRISHELL AUTOMATIC CISTERN

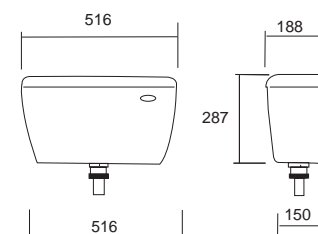

- S2199021** - Trishell 4.5 Itr Automatic Cistern Finish Black
- S2199022** - Trishell 4.5 Itr Automatic Cistern Finish White
- S2199023** - Trishell 9.0 Itr Automatic Cistern Finish Black
- S2199024** - Trishell 9.0 Itr Automatic Cistern Finish White
- S2199025** - Trishell 13.5 Itr Automatic Cistern Finish Black
- S2199026** - Trishell 13.5 Itr Automatic Cistern Finish White

### RUBBERWELL CISTERN

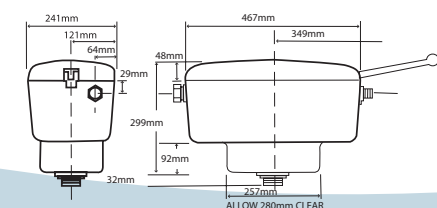

- S2172001** - Rubberwell Well Bottom High Level Hard Rubber cistern and Fittings with Chain Pull S.I.S.O. Finish Black

### VITREOUS CHINA HIGH LEVEL

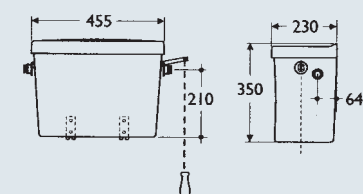

- P6831601** - Vitreous China High Level Cistern and Fittings with Chain Pull Finish White

For Concealed Cisterns See Page 144

Exposed Cisterns

Contractors Commercial Sanitaryware

MIRAGE CONCEALED CISTERN



**S2156501** - Mirage Concealed L/L Cistern with Type 'P' Lever Kit

**S2156511** - Mirage Concealed L/L Cistern with Type 'W' Lever Kit

**S2156521** - Mirage Concealed L/L Cistern with Type 'A' Lever Kit

**S2156551** - Type 'A' Lever Kit Only

'P' Kit - For Duct Thickness 12-60mm

'W' Kit - For Wall Thickness 114mm

'A' Kit - Combined Wall and Duct Thickness upto 390mm

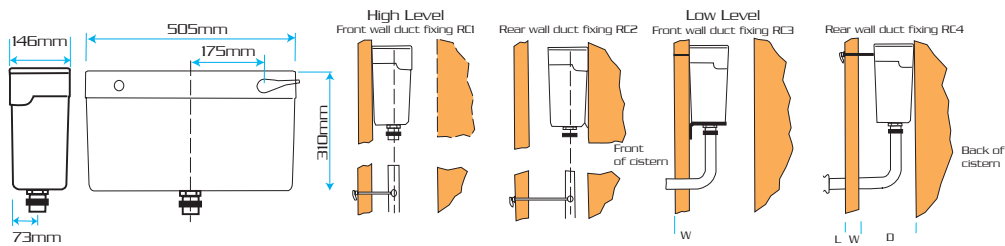

PHANTOM CONCEALED CISTERN

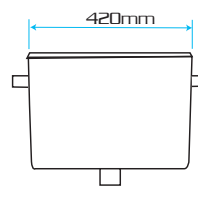

**S2156531** - Phantom Concealed L/L Cistern with Air Assisted Push Button Control C.P. Push Button S.I.S.O.

**S2156532** - Phantom Concealed L/L Cistern with Air Assisted Push Button Control C.P. Push Button B.I.B.O.

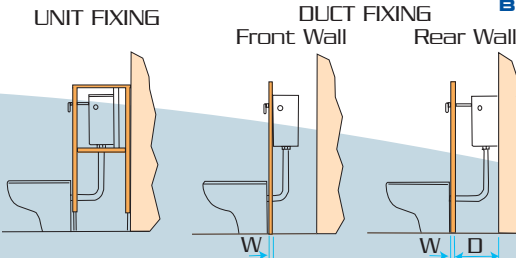

MIRAGE CONCEALED AUTOMATIC CISTERN

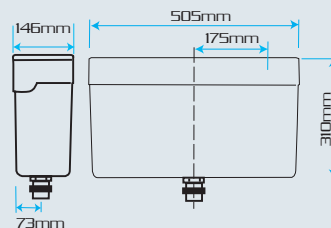

**S2199031** - Mirage Concealed 4.5 ltr Automatic Cistern for Urinals

**S2199032** - Mirage Concealed 9.0 ltr Automatic Cistern for Urinals

**S2199033** - Mirage Concealed 13.5 ltr Automatic Cistern for Urinals

Additional Concealed Cisterns Can be Found on Page 26

**Contractors Commercial Sanitaryware**

**PORTMAN CENTRE TAPHOLE**

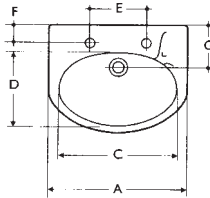

- S2066001 - Portman 600mm Centre Taphole with Overflow
- S2066011 - Portman 500mm Centre Taphole with Overflow
- S2066012 - Portman 400mm Centre Taphole with Overflow

A	B	C	D	E	F	G	L
400	365	330	220	100	70	170	190
500	420	445	280	200	76	170	200
600	480	530	330	200	76	170	230

**PORTMAN TWO TAPHOLE**

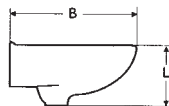

- S2066002 - Portman 600mm Two Taphole with Overflow
- S2066012 - Portman 500mm Two Taphole with Overflow
- S2066022 - Portman 400mm Two Taphole with Overflow

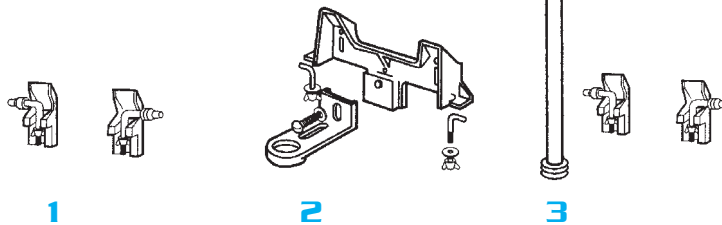

1. S2066501 - Concealed Hanger Bracket (To Suit 400mm Basin)
2. S2066502 - Concealed Hanger & Waste Bracket (To Suit All Sizes)
3. S2066503 - Centre Leg Support, for connecting through waste outlet. This can be used in conjunction with S2066501 concealed hanger brackets if wall fixing alone is inadequate.

This method of fixing is suitable for 500mm and 600mm basins. Height: 600mm, but may be cut to suit site requirements.

**HANDRINSE BASIN**

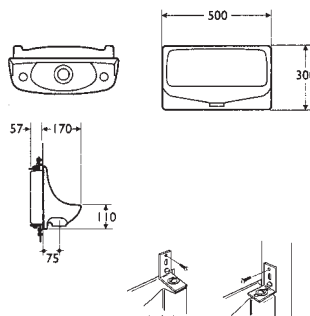

- S2080001 - Handrinse Basin 500mm One L/H Taphole no Overflow
- S2080002 - Handrinse Basin 500mm One R/H Taphole no Overflow
- S2080003 - Handrinse Basin 500mm Two Taphole no Overflow
- S2080011 - Fixing Brackets and Bolts to Suit Handrinse Basin

**CONTOUR CONCEALED OUTLET BASIN**

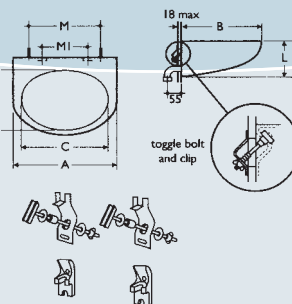

- S2101001 - Contour Concealed Outlet Basin 500mm no Taphole
- S2101031 - Concealed Hangers and Bolts
- S2101021 - Wall Mounted Concealed Mixer Fitting

A	B	C	D	L	M	M1
500	400	450	305	200	370	200

Wall Hung Basins

For Taps and Mixers See Page 179-186

**Contractors Commercial Sanitaryware**

**PLANET FULLY INSET BASIN**

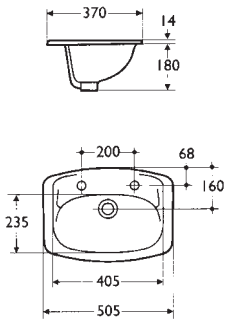

**S2082501** - Planet Fully Inset Basin  
Taphole 1 C/W Fixings

**S2082511** - Planet Fully Inset Basin  
Tapholes 2 C/W Fixings

**REGENCY FULLY INSET BASIN**

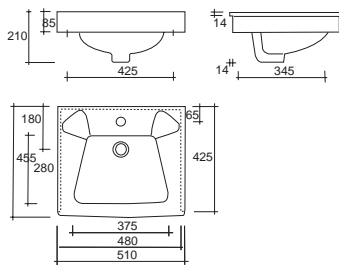

**S2081001** - Regency Fully Inset Basin  
With Front Fascia  
Tapholes 2

**S2081000** - Regency Fully Inset Basin  
With Front Fascia  
Taphole 1

**S2081021** - Toggle fixing Brackets  
for above

**SIRRUS FULLY INSET BASIN**

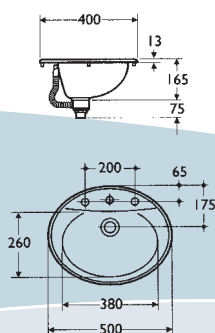

**S6100002** - SIRRUS Acetal Plastic  
Full Inset Basin  
Taphole 1

**S6100003** - SIRRUS Acetal Plastic  
Full Inset Basin  
Tapholes 2

(SIRRUS Basins Supplied With Waste Fitting)

**PROFILE SEMI COUNTERTOP BASIN**

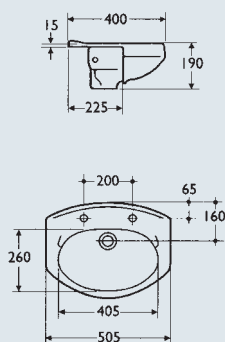

**S2085501** - Profile Semi Countertop  
Basin  
Taphole 1 C/w fixings

**S2085511** - Profile Semi Countertop  
Basin  
Tapholes 2 C/w fixings

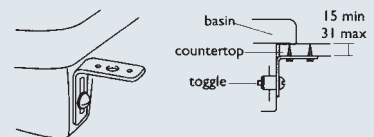

For Waste and Traps See Page 228-229

Inset Wash Basins



**Contractors Commercial Sanitaryware**

**ROUND PLUG BOWL**



**S6100004 - 40cm Round Plug Bowl with Overflow**

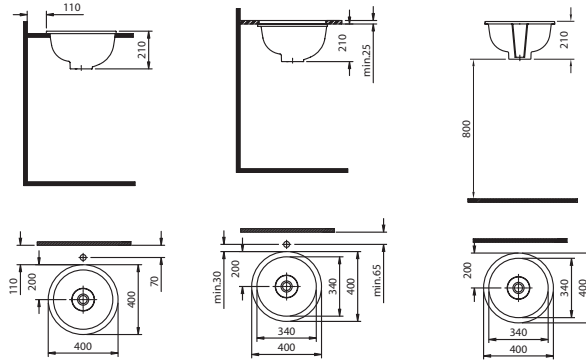

**INSET**

**UNDERCOUNTER**

**FREESTANDING**

**MARLOW PLUG BOWL**



**S2083001 - Marlow 48cm Plug Bowl with Overflow**

**S2083501 - Fixing Clips**

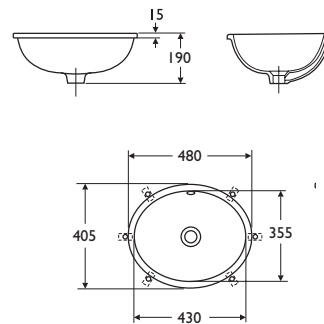

**OVAL PLUG BOWL**



**S2084001 - 57cm Oval Plug Bowl No Overflow Complete with Fixing Clips**

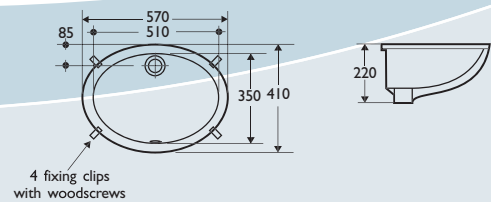

For Taps and Mixers See Page 179-186

## Contractors Commercial Sanitaryware

Geberit Duofix frames are designed to support wall hung sanitaryware without the need for supporting walls. All maintenance is carried out through the flush plate with all internal components accessible.



### DUOFIX 1.12M FRAME FOR WALL HUNG WC

All frames come with integrated front operated concealed cistern for single or dual flush and WC connector set.

- S6100005 - Universal Frame
- S6100006 - Pre-Wall Frame with Brackets and Drainage Connector
- S6100007 - Frame for Disabled WC with Greater Height and Front Projection:

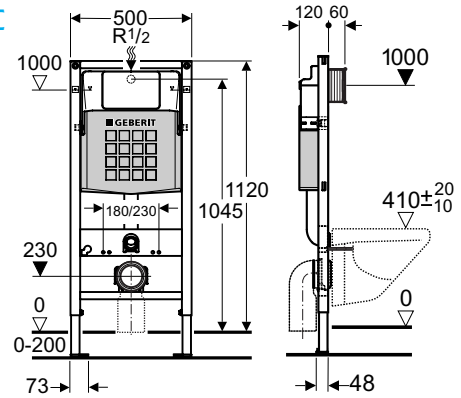

### DUOFIX 0.82/0.88M FRAME FOR WALL HUNG WC

All frames come with integrated front/top operated concealed cistern for single or dual flush, WC connector set. Pre-Wall brackets and drainage connectors

- S6100008 - 0.82m Frame
- S6100009 - 0.88m Frame

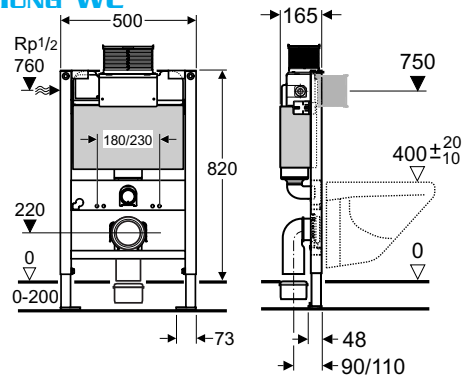

### CONCEALED DUAL FLUSH CISTERN

S6100010 - Single/Dual Flush Cistern for use with Front or Top Mounted Artline Plates

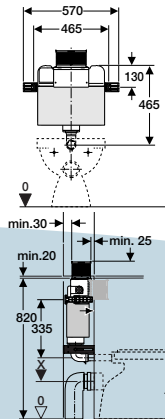
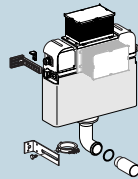

### CONCEALED DUAL FLUSH CISTERN

S6100015 - Single/Dual Flush Cistern For use with Front Mounted Plates

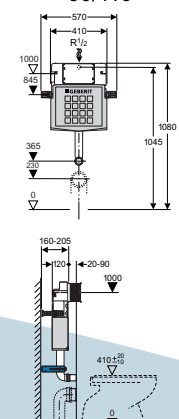
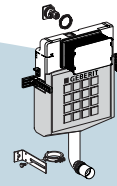

### ARTLINE DUAL FLUSH FLUSHING PLATES



213x142mm

- S6100011 - Chrome - Gloss
- S6100012 - Chrome - Matt

### ARTLINE ADAPTOR

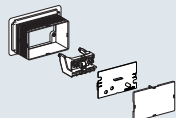

S6100013 - Artline Adaptor for use with 1.12m Frames and S6100015 Cisterns to allow the use of an Artline Flush Plate

### SAMBA DUAL FLUSH FLUSHING PLATES



246x164mm

- S6100050 - Chrome - Gloss
- S6100051 - Chrome - Matt

### RUMBA SINGLE FLUSH FLUSHING PLATES



246x164mm

- S6100052 - Chrome - Gloss
- S6100053 - Chrome - Matt

### TWIST DUAL FLUSH FLUSHING PLATES



246x164mm

- S6100016 - Chrome - Gloss
- S6100017 - Chrome - Matt:

### TANGO SINGLE FLUSH FLUSHING PLATE, ANTI VANDAL:



246x164mm

- S6100018 - Chrome - Gloss
- S6100019 - Chrome - Matt

**Contractors Commercial Sanitaryware**



**DUOFIX FRAMES FOR BASINS FOR USE WITH BASIN MOUNTED TAPS**

S6100020 - 1.12m Frame Drywall

S6100021 - 1.12m Frame Prewall with Brackets

S6100022 - 0.82/0.88m Frame Prewall with Brackets

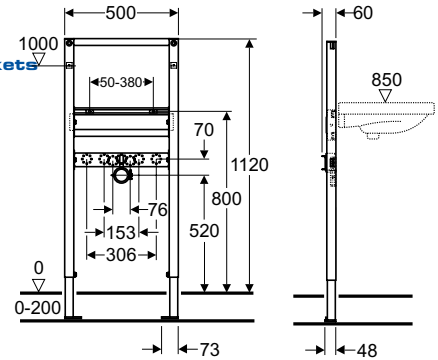

**DUOFIX FRAMES FOR BIDETS**

S6100023 - 1.12m Frame Drywall

S6100024 - 1.12m Frame Prewall with Brackets

S6100025 - 0.82m Frame Prewall with Brackets

S6100026 - 0.88m Frame Prewall with Brackets

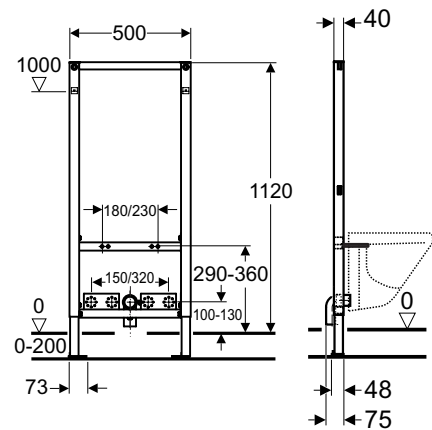

**DUOFIX FRAMES FOR URINALS**

S6100027 - Comes with Pipe interruptor & Universal Housing 1.3m Drywall

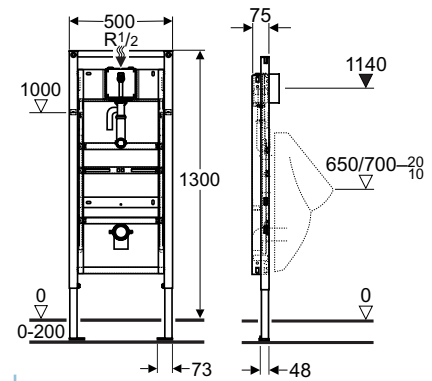

**UNIVERSAL URINAL HOUSING**

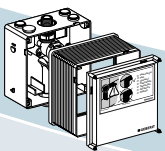

S6100028

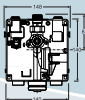

**INFRA-RED ELECTRONIC URINAL FLUSHING**

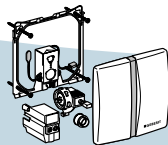

Mains Powered

S6100031 - White

S6100032 - Chrome - Matt

Battery Powered

S6100033 - White

S6100034 - Chrome - Matt

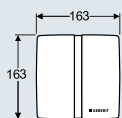

**PRE WALL BRACKETS UNIVERSAL**

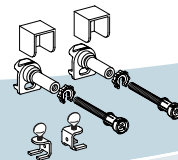

S6100014

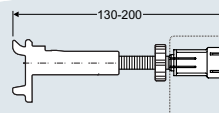

**HAND OPERATED PNEUMATIC URINAL FLUSH**



S6100029 - White

S6100030 - Chrome - Matt



In Wall Frame Flushing Systems

For Olympus Wall Hung Sanitaryware See Page 23



# The Geberit Shower Toilet

quality function design



## The Geberit Shower Toilet

Combines all the functions of a toilet and bidet, with comfort of warm air drying and odour extraction. With the push of a button, the spray arm extends from its protected position and a spray of warm water washes thoroughly for as long as the button is pressed. This is automatically followed by a gentle flow of warm drying air, which shuts off when leaving the toilet.

- available as floor or wall mounted unit
- adjustable hot air temperature
- adjustable water spray intensity
- optional remote control unit
- odour extractor via an active carbon filter that is easily changed
- a pressure sensitive switch on the toilet seat prevents spray arm functioning when unit is not in use.

For further information on the products above please contact N&C Sales and marketing on:

**020 7247 5432**

**Contractors Commercial Sanitaryware**

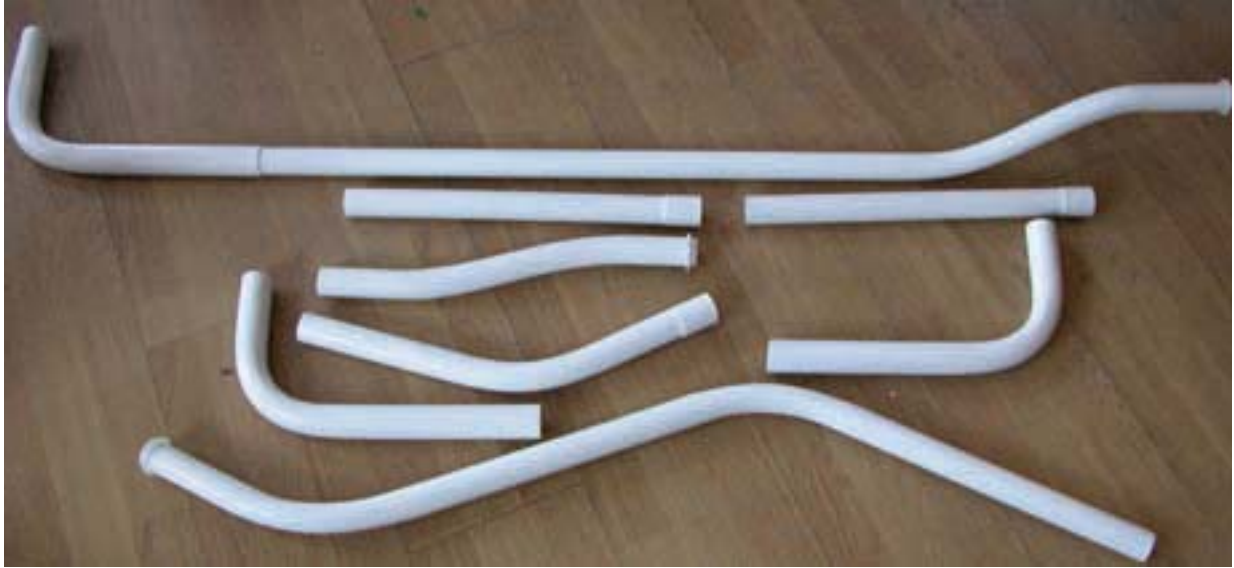

Flush pipes and Connectors

**FLUSH BEND**

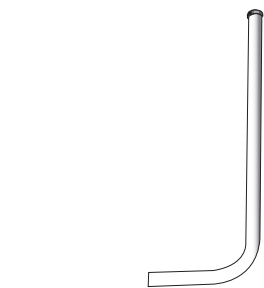

**S2177001** - 760 x 305mm Medium Level Flush Bend. White PVC

**ONE PIECE FLUSH PIPE**

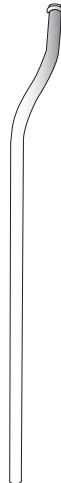

**S2177051** - One Piece High Level Flush Pipe For Top Inlet Closets and Sluices. White PVC

**TWO PIECE FLUSH PIPE**

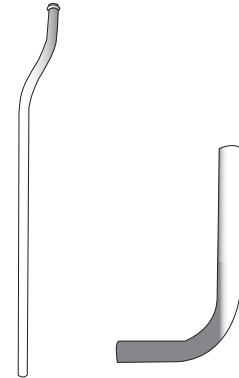

**S2177501** - Two Piece High Level Flush Pipe For Back Wall Fixing. White PVC

**THREE PIECE FLUSH PIPE**



**S2178001** - Three Peice High Level Flush Pipe For Side Wall Fixing. White PVC

**FOUR PIECE FLUSH PIPE**

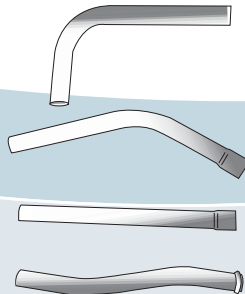

**S2178501** - Four Peice High Level Flush Pipe White PVC

**CLOSET CONE**



**S2176001** - 32mm Moulded PVC Closet Cone

**S2176011** - 38mm Moulded PVC Closet Cone

**SPUD-INLET CONNECTOR**



**S2176501** - Spud Inlet Connector



**Contractors Commercial Sanitaryware**

**Turbo 88**



- S2176601 - Turbo 88 9" 2 Part Syphon 6.5 Ltr / 7 Ltr / 9 Ltr
- S2176602 - Turbo 88 8" 2 Part Syphon 6.5 Ltr / 7 Ltr / 9 Ltr

**Side Inlet Fluidmaster Quiet Floatvalve**



- S2184821 - Fluidmaster Quiet Floatvalve

**Bottom Inlet Fluidmaster Quiet Floatvalve**



- S2184811 - Fluidmaster Quiet Floatvalve

**Rigidflex Flexible W.C. Pan Connector**



- S2184801 - Rigidflex Flexible W.C. Pan Connector (Extends 230 - 570mm)

**MULTIKWIK PAN CONNECTOR**



A range of flexible connectors suitable for soil pipes of any material having an internal diameter of 102mm. The connectors are self sealing and do not require putty, mastic or cement for fixing. The flexibility of the connector ensures that the pan outlet is not cracked due to subsidence or movement. Especially suited for wooden floors and mobile homes. It also enables the quick removal of a pan in the event of a blockage without damaging the pan outlet.

**METHOD OF FIXING:**

The pan outlet is pushed downwards into the top section of the connector, resulting in a firm and watertight grip to the pan outlet. The bottom section of the connector is inserted in the soil pipe and pushed fully down, thereby firmly pressing the outward facing flexible flanges against any water pressure. The closet is then fastened into position.

**Multikwik 14 degree Connector**

- S2183701 - For fixing to closets



with horizontal outlet to give a 'P' trap connection

**MULTIKWIK 90 DEGREE CONNECTOR**



- S2183901 - For fixing to closets with horizontal outlet to give 'S' trap or turned 'P' trap connection

**MULTIKWIK STRAIGHT CONNECTOR**



- S2184101 - Model No. 1 For 'P' or 'S' trap closets To suit pan spigots 108-115mm O.D.
- S2184102 - Model No.2 To suit pan spigots 102mm O.D.
- S2184103 - Model No.5 To suit pan spigots 76-95mm O.D.

**MULTIKWIK OFFSET CONNECTOR**



- S2184301 - Model No. 1 Offset For 'P' or 'S' trap closets To suit pan spigots 108-115mm O.D. (Allowing a 15mm variation in the two axis of soil pipe and pan spigot)

**MULTIKWIK BENT CONNECTOR**



- S2184501 - For converting 'P' trap closets to 'S' trap. To suit pan spigots 108-115mm O.D.

**MULTIKWIK EXTENSION PIECE**



- S2184701 - Suitable for bridging awkward gaps. Overall length 255mm, including a 150mm length of plain pipe which can be cut to requirements. To be used in conjunction with Multikwik connectors for 'P' or 'S' trap closets (not horizontal outlet patterns)

**Contractors Commercial Sanitaryware**



**S2180001** - BSS Single Seat Plastic Hinge & Rod Finish Black

**S2180011** - BSS Single Seat Chrome Hinge & Rod Finish Black

**S2180510** - BSS Single Seat Chrome Hinge & Rod Finish White



**S2182501** - Open Front Seat only Plastic Hinges & Rod (to suit 405mm & 355mm Pans) Finish Black

**S2182502** - Open Front Seat only Plastic Hinges & Rod (to suit 405mm & 355mm Pans) Finish White



**S7004032** - Olympus Seat & Cover Stainless Steel Top Fixing Hinges Finish White



**S2180501** - BSS Seat & Cover Plastic Hinge & Rod Finish Black

**S2180502** - BSS Seat & Cover Plastic Hinge & Rod Finish White

**S2180511** - BSS Seat & Cover Chrome Hinge & Rod Finish Black

**S2180512** - BSS Seat & Cover Chrome Hinge & Rod Finish White



**S2182511** - Open Front Seat Plastic Hinges & Rod (to suit 305mm Pans) Finish Black

**S2182512** - Open Front Seat Plastic Hinges & Rod (to suit 305mm Pans) Finish White



**S2182701** - Tivoli Heavy Duty Seat and Cover Stainless Steel Hinges Finish Black

**S2182702** - Tivoli Heavy Duty Seat and Cover Stainless Steel Hinges Finish White



**S2181001** - Medium Weight Seat & Cover Plastic Hinge & Rod Finish Black

**S2181002** - Medium Weight Seat & Cover Plastic Hinge & Rod Finish White

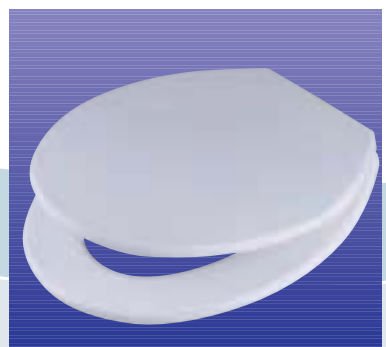

**S7000003** - Aintree Seat & Cover Plastic Hinges & Rod Finish Black

**S7000004** - Aintree Seat & Cover Plastic Hinges & Rod Finish White



**S2151031** - Astra Seat and Cover Top Fixing Hinge Finish White

**Toilet Seats**

Contractors Commercial Sanitaryware



S2153031 - Orion Seat and Cover Finish White



S2157511 - Gemini Seat and Cover Top Fixing Hinges Finish white



S6100035 - Liberty Seat and Cover with Stainless Steel Hinges in White. Ergonomically Designed to Aid Toileting



S2183501 - Broadgate Wood Effect Seat and Cover Pine with Chrome Hinge

S2183502 - Broadgate Wood Effect Seat and Cover Pine with Brass Hinge



S2183503 - Broadgate Wood Effect Seat and Cover Mahogany with Chrome Hinge

S2183504 - Broadgate Wood Effect Seat and Cover Mahogany with Brass Hinge



S7001076 - Maple Effect Seat and Cover with Chrome Hinge

S7001077 - Maple Effect Seat and Cover with Brass Hinge



S7001078 - Pine Effect Seat and Cover with Chrome Hinge

S7001079 - Pine Effect Seat and Cover with Brass Hinge



S7001094 - Mahogany Effect Seat and Cover with Chrome Hinge

S7001095 - Mahogany Effect Seat and Cover with Polished brass Hinge

Wooden Toilet Seats



## Ideal-Standard and Armitage Shanks - the fitting choice for quality bathroom, washroom and shower brands.

Ideal-Standard, Armitage Shanks and Trevi offer a range of bathroom, washroom and shower brands that are second to none. Behind such famous names as Space, Studio, Montana and Sandringham, they've always been the choice of the true professional.

*Ideal  
Standard*

*Armitage  
Shanks*

Bathroom Suites Modern Style

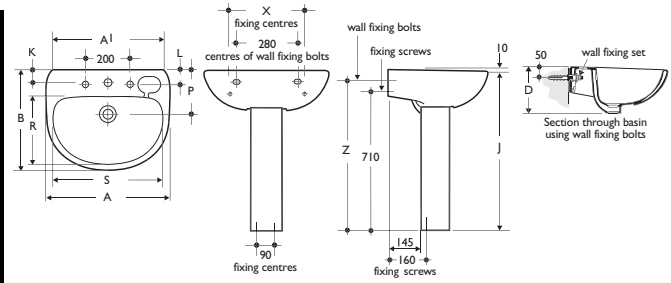

A	A1	B	D	J	K	L	P	R	S	X	Z
560	500	455	215	805	60	70	200	310	490	340	765
500	450	425	215	800	60	70	200	285	445	330	760

- S7001001 - 56cm Basin TH1 White
- S7001002 - 56cm Basin TH1 Cream
- S7001003 - 56cm Basin TH2 White
- S7001004 - 56cm Basin TH2 Cream
- S7001097 - 50cm Basin TH1 White
- S7001151 - 50cm Basin TH1 Cream
- S7001152 - 50cm Basin TH2 White
- S7001153 - 50cm Basin TH2 Cream

- S7001005 - Pedestal White
- S7001006 - Pedestal Cream

Studio range Wash Basins

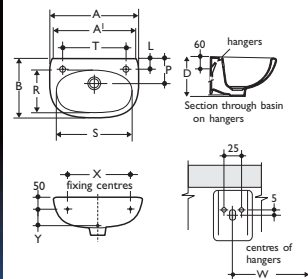
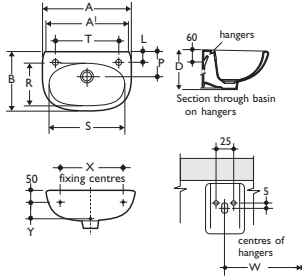

A	A1	B	D	L	P	R	S	T	W	X	Y
450	425	300	180	55	125	215	380	320	350	370	110
350	330	250	150	40	110	175	290	240	150	270	80

- S7001007 - 45cm Wall Basin TH2 White
- S7001008 - 45cm Wall Basin TH2 Cream
- S7001009 - 35cm Wall Basin TH2 White
- S7001010 - 35cm Wall Basin TH2 Cream
- S7001096 - Wall Hanger Brackets

- S7001011 - 45cm Pedestal Basin TH2 White
- S7001012 - 45cm Pedestal Basin TH2 Cream
- S7001013 - Cloakroom Pedestal White
- S7001014 - Cloakroom Pedestal Cream

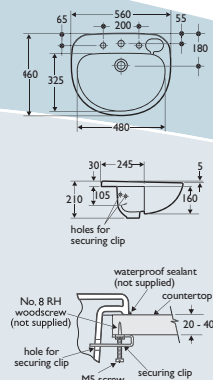
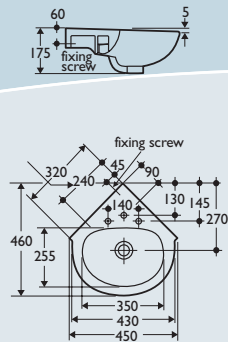

- S7002027 - 45cm Corner Basin TH1 White
- S7001096 - Wall Hanger Brackets

- S7001026 - 56cm Semi Countertop Basin TH1 White
- S7001027 - 56cm Semi Countertop Basin TH1 Cream
- S7001028 - 56cm Semi Countertop Basin TH2 White
- S7001029 - 56cm Semi Countertop Basin TH2 Cream

For Taps and Mixers See Page 179-186



## Bathroom Suites Modern Style

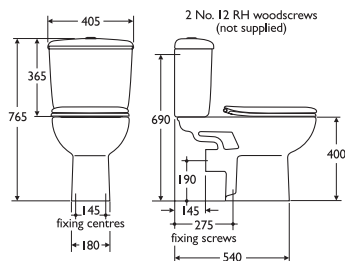

- S7001015 - C/C WC Pan White
- S7001016 - C/C WC Pan Cream
- S7001017 - Cistern & Push Button Fittings White
- S7001018 - Cistern & Push Button Fittings Cream
- S7001024 - Seat & Cover S/Steel Hinge White
- S7001025 - Seat & Cover S/Steel Hinge Cream

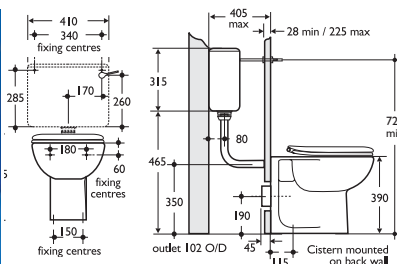

- S7001019 - Back To Wall Pan White
- S7001020 - Back To Wall Pan Cream
- S7001024 - Seat and Cover S/Steel Hinge White
- S7001025 - Seat and Cover S/Steel Hinge Cream
- S7001023 - Concealed Cistern for Above (No Lever)
- S7001021 - 28mm Lever Chrome Alternative
- S7001022 - 405mm Lever Chrome



- S7001030 - 170cm x 70cm Idealform Bath TH2 White with Colour Matched Twingrips
- S7001031 - 170cm x 70cm Idealform Bath TH2 Cream with Colour Matched Twingrips
- S7001032 - 170cm Uniline front Panel White
- S7001033 - 170cm Uniline front Panel Cream
- S7001034 - 70cm Uniline End Panel White
- S7001035 - 70cm Uniline End Panel Cream

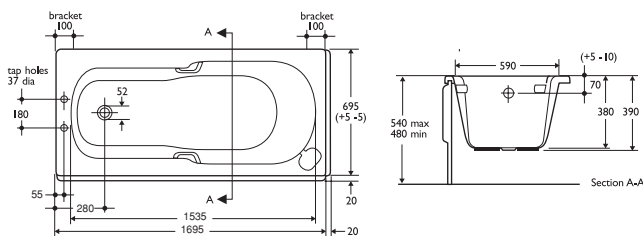

- S7001036 - 170cm x 65cm Spacemaker Idealform Bath White with Colour Matched Handgrip No Tapholes Left Hand
- S7001037 - 170cm x 65cm Spacemaker Idealform Bath Cream with Colour Matched Handgrip No Tapholes Left Hand
- S7001038 - 170cm x 65cm Spacemaker Idealform Bath White with Colour Matched Handgrip No Tapholes Right Hand
- S7001039 - 170cm x 65cm Spacemaker Idealform Bath Cream with Colour Matched Handgrip No Tapholes Right Hand
- S7001040 - Spacemaker Shaped Front Panel White
- S7001041 - Spacemaker Shaped Front Panel Cream
- S7001034 - 70cm Uniline End Panel White
- S7001035 - 70cm Uniline End Panel Cream

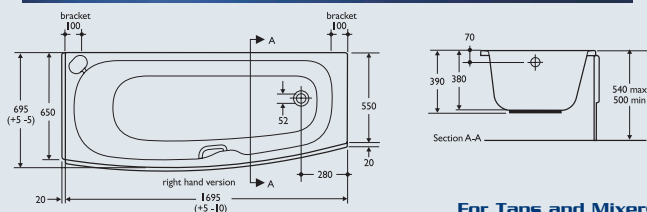

For Taps and Mixers See Page 179-186

Studio Range W.C.s & Baths

Bathroom Suites Traditional Style



- S7001042 - 60CM Basin TH2 White
- S7001043 - 60CM Basin TH2 Old English White
- S7001044 - Pedestal White
- S7001045 - Pedestal Old English White

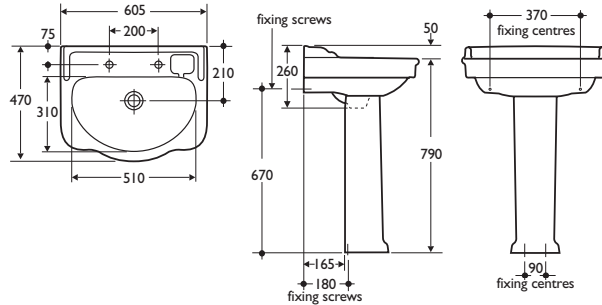

- S7001046 - 45cm Handrinse Basin TH2 White
- S7001047 - 45cm Handrinse Basin TH2 Old English White
- S7001096 - Wall Hanger Brackets

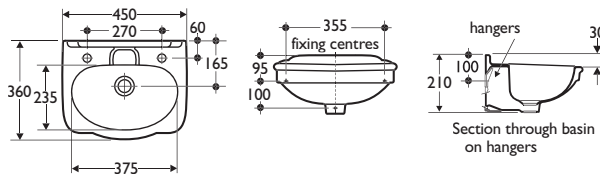

- S7001048 - 45cm Cloakroom Pedestal Basin TH2 White
- S7001049 - 45cm Cloakroom Pedestal Basin TH2 Old English White
- S7001050 - Cloakroom Pedestal White
- S7001051 - Cloakroom Pedestal Old English White

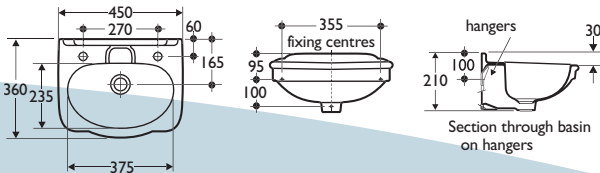

- S7001052 - C/C W.C. Pan White
- S7001053 - C/C W.C. Pan Old English White
- S7001054 - C/C Cistern (no lever) White
- S7001055 - C/C Cistern (no lever) Old English White
- S7001056 - Chrome Cistern Lever White Porcelain Insert
- S7001057 - Chrome Cistern Lever Old English White Porcelain Insert
- S7001088 - Trad, Gold Cistern Lever White Porcelain Insert
- S7001089 - Trad, Gold Cistern Lever Old English White Porcelain Insert

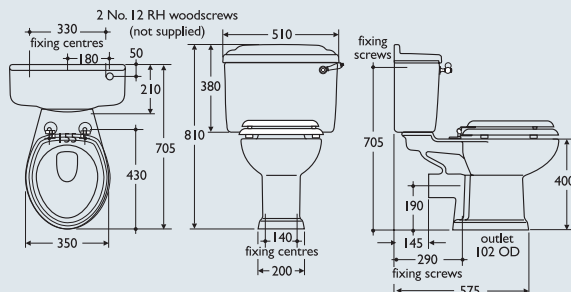

For Wooden Toilet Seats See Page 154

**Bathroom Suites Traditional Style**

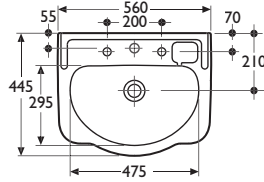

**S7001058** - 56cm Semi Countertop Basin TH1 White

**S7001059** - 56cm Semi Countertop Basin TH1 Old English White

**S7001060** - 56cm Semi Countertop Basin TH2 White

**S7001061** - 56cm Semi Countertop Basin TH2 Old English White

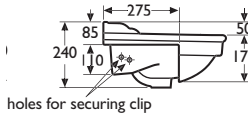

holes for securing clip

waterproof sealant (not supplied)

countertop

20 - 40

securing clip

M5 screw

hole for securing clip

No. 8 RH woodscrews (not supplied)



**S7001090** - Harrow 170 x70cm Idealform Plain Bath No Handgrips TH2 White

**S7001091** - Harrow 170 x70cm Idealform Plain Bath No Handgrips TH2 Old English White

**Reflection Range**

For Taps and Mixers See Page 179-186

**Bathroom Suites Traditional Style**

**PRINCESS**

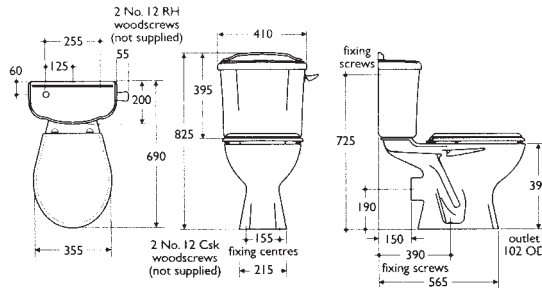

- S7001062 - Fluted C/C Pan White
- S7001063 - Fluted C/C Pan Old English White
- S7001064 - Duchess Cistern (No Lever) White
- S7001065 - Duchess Cistern (No Lever) Old English White
- S7001066 - Princess Cistern (No Lever) White
- S7001067 - Princess Cistern (No Lever) Old English White
- S7001074 - Side Action Cistern Lever Chrome
- S7001075 - Side Action Cistern Lever Light gold

**DUCHESS**

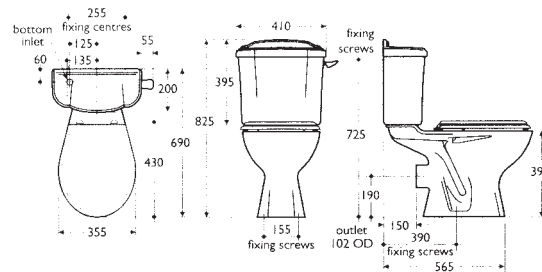

**DUCHESS**

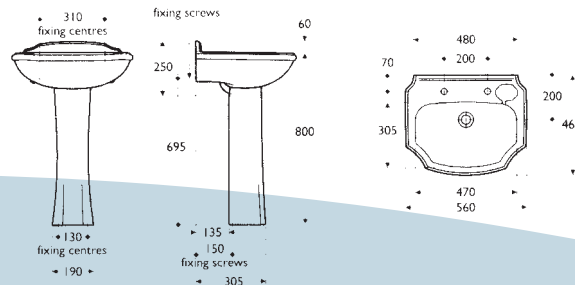

- S7001068 - Duchess 56cm Basin TH2 White
- S7001069 - Duchess 56cm Basin TH2 Old English White
- S7001072 - Fluted Pedestal White
- S7001073 - Fluted Pedestal Old English White

**PRINCESS**

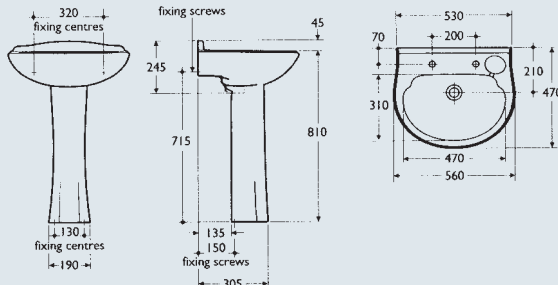

- S7001070 - Princess 56cm Basin TH2 White
- S7001071 - Princess 56cm Basin TH2 Old English White
- S7001072 - Fluted Pedestal White
- S7001073 - Fluted Pedestal Old English White

For Wood Effect Bath Panels See Page 137

## Bathroom Suites Space Saving

Utilizing the space range multi-purpose w.c. pan close coupled, corner, or back to wall configuration

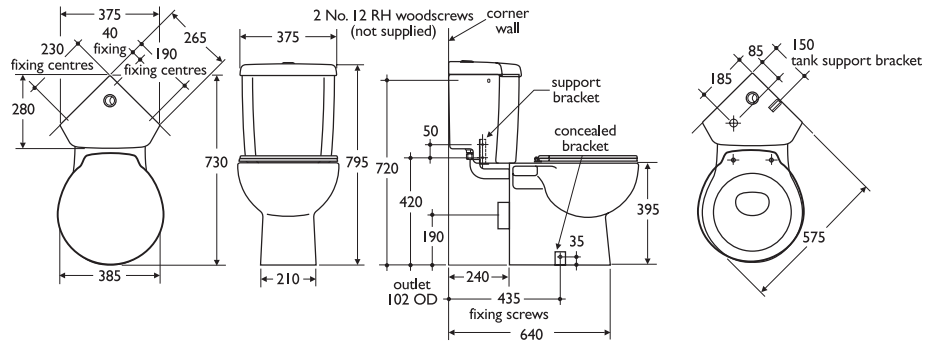

- S7001120 - C/C Corner Pan. H.O White
- S7001127 - C/C Corner Cistern Dual Flush, Push Button White
- S7001126 - Seat and Cover White

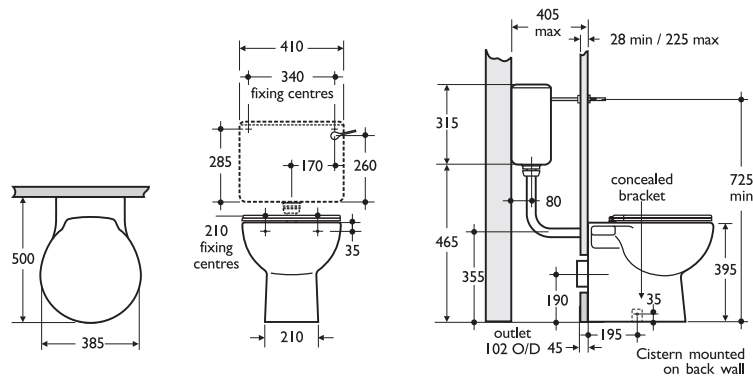

- S7001120 - Back to Wall Pan. H.O White
- S7001121 - Concealed Cistern (no Lever)
- S7001126 - Seat and Cover White
- S7001122 - 28mm Lever Chrome
- Alternative
- S7001122 - 405mm Lever Chrome

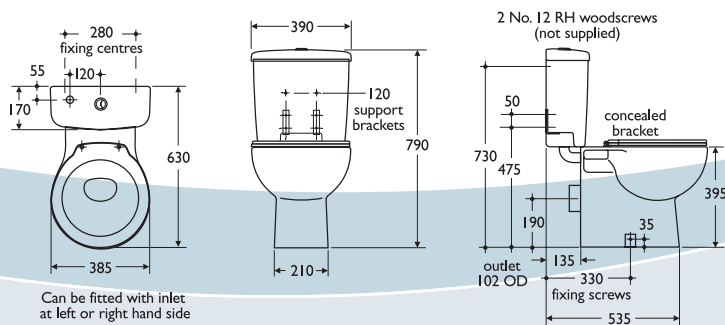

- S7001120 - C/C Pan. H.O White
- S7001134 - C/C Push Button Cistern White
- S7001126 - Seat and Cover White

Space Range W.C.'S



Bathroom Suites Space Saving

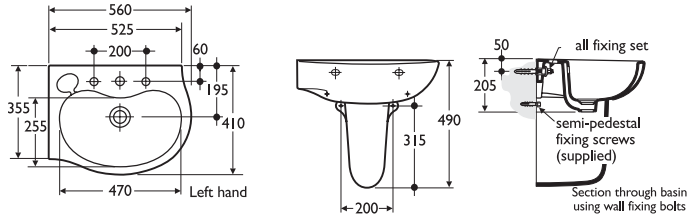

- S7001110 - 56cm Offset Corner Basin Left Hand TH1 White
- S7001112 - 56cm Offset Corner Basin Right Hand TH1 White
- S7001111 - 56cm Offset Corner Basin Left Hand TH2 White
- S7001113 - 56cm Offset Corner Basin Right Hand TH2 White
- S7001137 - Basin Wall Fixing Set
- S7001136 - Semi Pedestal White

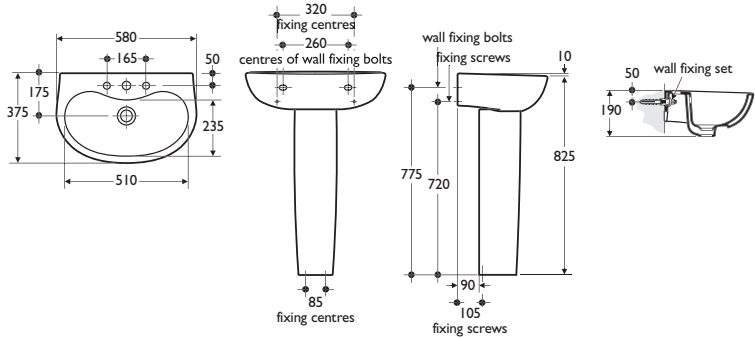

- S7001114 - 58cm Short Projection Basin TH1 White
  - S7001115 - 58cm Short Projection Basin TH2 White
  - S7001137 - Basin Wall Fixing Set
  - S7001138 - Pedestal White
- (This Pedestal can also be used with offset corner basin)

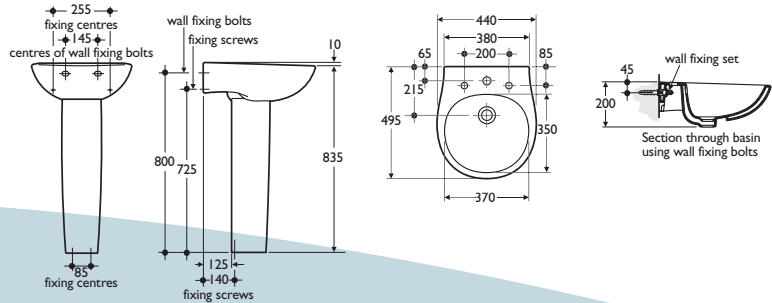

- S7001116 - 44cm Narrow Basin TH1 White
- S7001117 - 44cm Narrow Basin TH2 White
- S7001137 - Basin Wall Fixing Set
- S7001138 - Pedestal White

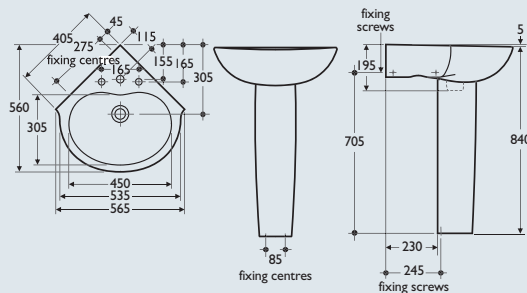

- S7001118 - 56cm Corner Basin TH1 White
- S7001119 - 56cm Corner Basin TH2 White
- S7001138 - Pedestal White

For Taps and Mixers See Page 179-186

**Bathroom Suites Space Saving**

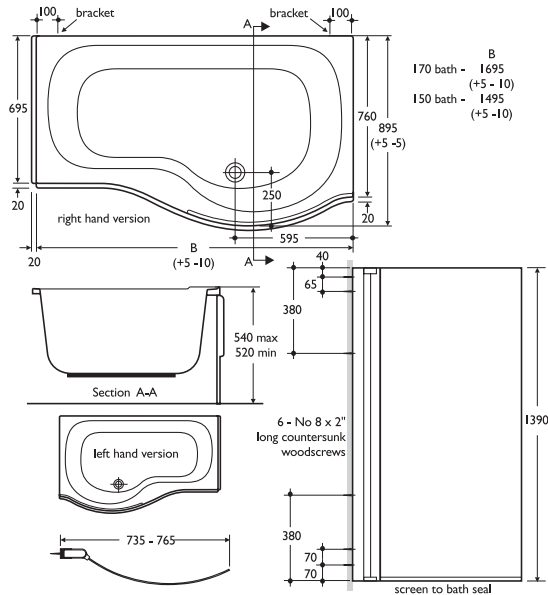

- S7001128 - 150cm Idealform Offset Corner Shower Bath Left Hand No Tapholes including Panel White**
- S7001129 - 150cm Idealform Offset Corner Shower Bath Right Hand No Tapholes including Panel White**
- S7001143 - 170cm Idealform Offset Corner Shower Bath Left Hand No Tapholes including Panel White**
- S7001144 - 170cm Idealform Offset Corner Shower Bath Right Hand No Tapholes including Panel White**
- S7001034 - 70cm uniline End Panel White**

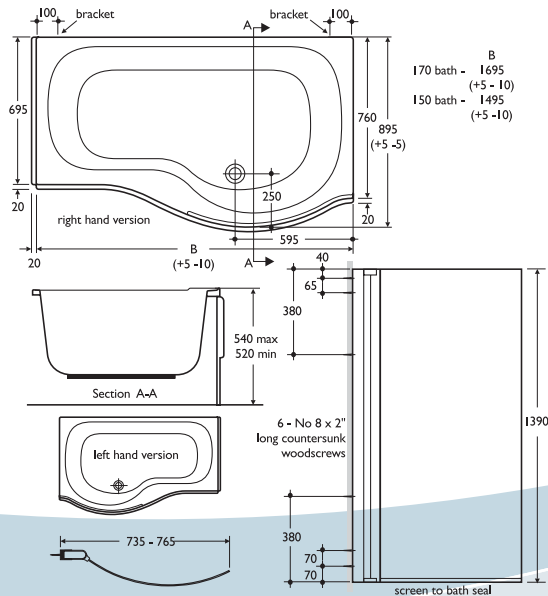

- S7001130 - Bath Shower Screen for above Right Hand Clear Glass, Silver Hinge**
- S7001131 - Bath Shower Screen for above Left Hand Clear Glass, Silver Hinge**
- S7001132 - Bath Shower Screen for above Right Hand Clear Glass, White Hinge**
- S7001133 - Bath Shower Screen for above Left Hand Clear Glass, White Hinge**

For Taps and Mixers See Page 179-186

Space Range Baths

## Bathroom Suite Economy



- S2160011 - C/C W.C. Pan H.O. White
- S2153001 - C/C Cistern With Chrome Lever White
- S2153031 - Orion Seat And Cover White

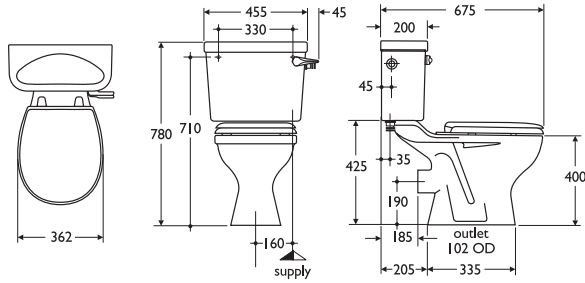

- S2000185 - 58cm TH2 Basin White
- S2000186 - 58cm TH1 Basin White
- S2060001 - Pedestal White

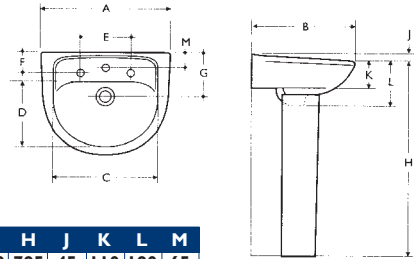

A	B	C	D	E	F	G	H	J	K	L	M
580	475	480	310	200	78	180	795	45	110	190	65

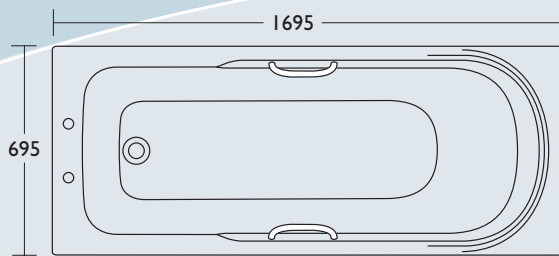

- S7002028 - Baronet 170 x 70cm Twingrip Acrylic Bath With Chrome Handgrips TH2 White

Baronet Bath, height, floor to rim 490-540mm

For Taps and Mixers See Page 179-186

## N&C Olympus Bathroom Furniture

### TRANSFORM YOUR BATHROOM WITH OLYMPUS

Olympus fitted bathroom furniture comprises an impressive range of stylish door finishes and cabinet colours that combine high quality with sensible prices.

It's choice complemented with a wide selection of optional accessories and co-ordinating tops designed to complete the bathroom you've always wanted.

Meticulous attention to detail, with all cabinets produced to the same specification, ensures you enjoy attractive fitted bathroom furniture of tasteful proportions that makes the most practical use of space.

Doors are not supplied with a handle. Select handles to your preferred choice.

All cabinets are available ready assembled or flat pack, with timber matched carcasses as an option on wood effect doors.

Most styles in the latest choice of refreshing colours.

### DOOR COLLECTION



The exciting colourways illustrated below are exclusively available as a choice of options for Milan, Rimini, Turin and Cannes.



Vanity Furniture

#### DOOR STYLE/COLOUR SELECTION

- |                              |                            |                             |
|------------------------------|----------------------------|-----------------------------|
| 1. Milan/White               | 7. Tuscany/White           | 14. Warwick/Birch Effect    |
| 2. Roma/High Gloss Laminate  | 8. Malvern/Pearwood Effect | 15. Sage                    |
| 3. Florence/Cream Ash Effect | 9. Tavistock/Beech Effect  | 16. Cannes/Soft Cream       |
| 4. Banbury/White             | 10. Ocean                  | 17. Naples/White Ash Effect |
| 5. Vanille                   | 11. Turin/Beech Effect     | 18. Heysham/Limed Effect    |
| 6. Rimini/Birch Effect       | 12. Vienna/Soft Cream      | 19. Modena/White High Gloss |
|                              | 13. Stratford/beech Effect |                             |

WE HAVE SHOWN OUR COMPLETE COLLECTION OF DOOR STYLES WITH COMPLEMENTING HANDLES AND WORK TOPS. PLEASE REQUEST OUR DETAILED FULL COLOUR BROCHURE AND PRICE LIST FOR SPECIFICATION DETAILS AND RANGE CONTENT.

**N&C Olympus Bathroom Furniture**



**Handle Collection**



**B-Metal  
Ref:01**



**B1-Metal  
Ref:02**



**B1-Metal  
Ref:03**



**Brass  
Ref:04**



**Crystal/Brass  
Ref:08**



**Crystal/Chrome  
Ref:09**



**White  
Ref:10**



**Soft Cream  
Ref:11**



**Brass  
Ref:05**



**Chrome  
Ref:06**



**Ceramic/Brass  
Ref:07**



**Brushed Nickel  
Ref:14**



**Chrome Waves  
Ref:20**



**Chrome tapered  
Ref:15**



**Chrome Shaker  
Ref:17**



**Pergamon  
Ref:12**



**Brushed Nickel  
Ref:13**



**Chrome Bevelled  
Ref:16**



**Chrome Slalom  
Ref:18**



**Chrome Zig-Zag  
Ref:19**

**Worktop Collection**



**COLOUR SELECTION**

1. White
2. Birch
3. Malvern
4. Heysham
5. Beech
6. Topaz High Gloss
7. Emerald High Gloss
8. Blue Quartz High Gloss
9. Marine
10. White high Gloss
11. Granite High Gloss
12. Roma High Gloss
13. Soft Cream
14. Braemar

WE HAVE SHOWN OUR COMPLETE COLLECTION OF DOOR STYLES WITH COMPLEMENTING HANDLES AND WORK TOPS. PLEASE REQUEST OUR DETAILED FULL COLOUR BROCHURE AND PRICE LIST FOR SPECIFICATION DETAILS AND RANGE CONTENT.



**Garland Freestanding Vanity Unit**



**S7006020 - OL80 Garland Freestanding Vanity Unit 60cm Complete With Washbasin TH1 Finish White**

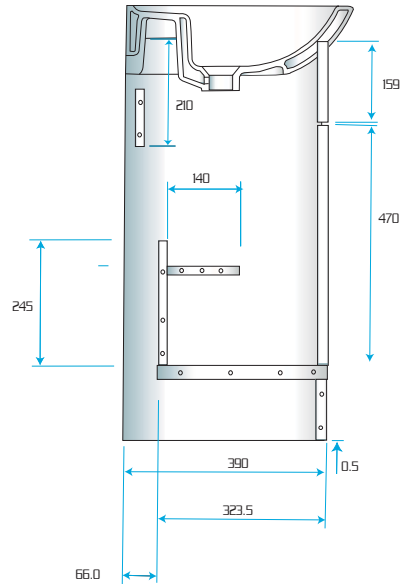

**Freesia Freestanding Vanity Unit**



**S2092501 - Freesia Freestanding Vanity Unit 60cm Complete With Worktop Finish White Door/White Worktop**

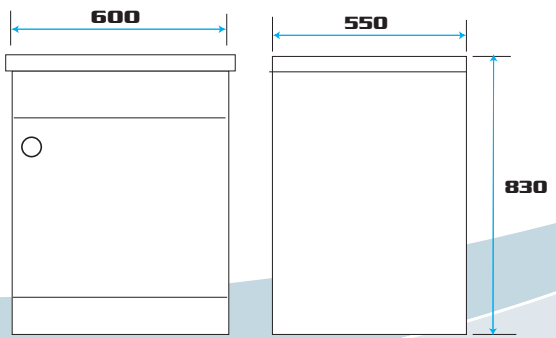

Specify Inset Basin Separately See Page 20 For Details



170° fully adjustable door hinge

For Taps and Mixers See Page 53-66

## N&C Olympus Glass Bowls

We have featured a selection of glass bowls and glass vanity tops on these pages.

Glass has become a very popular material to use within the bathroom over recent years, whether in the form of a wash basin or vanity surface, or indeed to tile the floors and walls with our glass 'Live Tile' range.

Our glass bowls and tops are available to order only in a wide range of styles and colours, we have chosen a small selection to depict. Please contact our sales office for further and more detailed information.



PLEASE CONTACT OUR SALES OFFICE FOR FULL COLOUR BROCHURE

Glass Bowls

**N&C Olympus Glass Bowls**



**Glass Bowls**

PLEASE CONTACT OUR SALES OFFICE FOR FULL COLOUR BROCHURE



## Ultimate Range

For many years N&C have been associated with the manufacture and supply of high quality washroom facilities.

During this time our name has been recognised as a mark of design quality and service. From time to time there emerges a design or style that incorporates superior quality, long life, low maintenance and colour options that will appeal to architects and designers. The "Ultimate Range" incorporates and represents complete washrooms, wall panelling, cubicles, vanity units, light pelmets and special fitments that may be required. From the very beginning to completion the "Ultimate Range" is ahead of all others

### PRESIDENT STYLE

**President** represents quality, style and design with variable colour options, giving greater flexibility for architects and designers.

The **President** style is illustrated in both feminine Pink and Masculine Blue. One design two colour scheme as an example. President is available with any of our colour selection in addition to our special colour schemes to meet design specifications.

The **President** style is fabricated using the highest grade core material, laminate and hardware, produced to a specification and quality in accordance with ISO 9002.

Cubicle partitions and doors, are formed using moisture resistant core bonded with high pressure laminate to a thickness of 20mm. edges are square edge finish, centre and wall pillasters are 26mm thickness post formed on vertical facing edges. The framed duct panel system is a factory manufactured birch plywood frame with post formed laminate panels already fitted and supplied as one unit ready to install.



President style washroom perstop Coral PP 1840 UN main Colour with Flamingo PP1233 UN



Emergency access indicator lock aluminium with stainless steel finish



Support leg aluminium with stainless steel finish

### PRESIDENT PLAIN COLOUR SELECTION

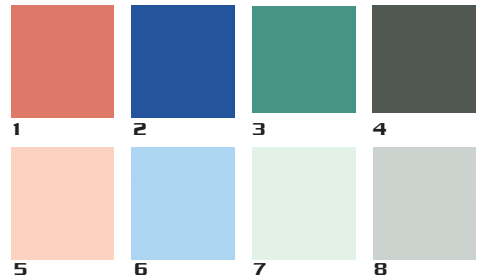

COLOUR SELECTION	
1. Coral	PP 1840 UN
2. Oceano	PP 1997 UN
3. Mousse	M 047
4. Storm	7912 CS
5. Flamingo	PP 1233 UN
6. Iris	PP1194 UN
7. Aigue Marie	A 014
8. Folkstone	7927 CS



Cubicle with full height framed duct panel system



Oceano PP1997 UN (main colour) with iris PP 1194 Un Light Blue

Furniture and hardware designed to enhance the style and quality of the "President", is stainless steel finished aluminium, Alternatively, high grade aluminium silver satin anodised finish or epoxy powder coating colour to match or contrast for effect.



Emergency access indicator lock silver satin with anodised finish



Support leg aluminium with silver satin anodised finish

### PRESIDENT TEXTURED COLOUR

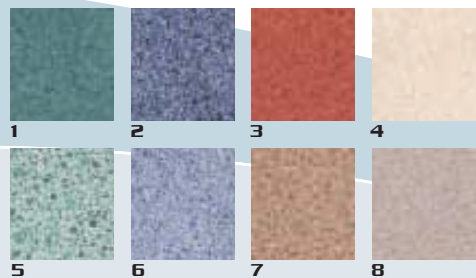

COLOUR SELECTION	
1. Nova Mousse	N 028 Surf
2. Nova Saphir	N 023 Surf
3. Nova Argile	N 049 Surf
4. Nova Vanille	N 021 Surf
5. Cosmic Vert	C 031 Surf
6. Nova Lilas	N 022 Surf
7. Cosmic Rose	C 032 Surf
8. Rose Ash	7504 Grafix



Urinal fitted to the frame duct panel system

● printed colours may vary from actual Laminate .  
 Laminate Samples Available on Request

## Ultimate Range

### DIRECTOR STYLE

The **Director** high quality washroom system manufactured to the high specification of the "Ultimate" range is designed for installation with or without framed wall paneling, whilst retaining the soft look of post formed edges throughout.

Designed to Enhance prestige locations where only the very best will do. The **Director** style colour selection compliments the soft look of quality.

The **Director** style of washroom facility is manufactured incorporating a moisture resistant core throughout bonded with high pressure laminate to all surfaces.

Cubicle partitions and doors are bonded with high pressure laminate to a thickness of 20mm. Edges are square edge finished, centre and wall pillasters are 26mm thickness post formed on vertical facing edges.



Nova Mousse N028 Surf main colour with Cosmic Vert C031 Surf illustrated



Indicator lock with emergency access aluminium with silver satin anodised finish

### DIRECTOR TEXTURED COLOUR SELECTION

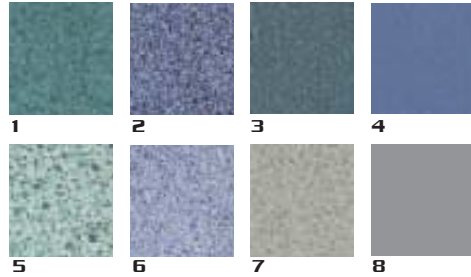

Cubicle with full height framed duct panel system



Support leg aluminium silver satin Anodised finish

### COLOUR SELECTION

1. Nova Mousse N 028 Surf
2. Nova Saphir N 023 Surf
3. Azurite PP 5573 CR
4. Emir PP 5687 UN
5. Cosmic Vert C 031 Surf
6. Nova Lilas N 022 Surf
7. Nickel PP5582 CR
8. Arabesco PP 5815 UN

### EXECUTIVE STYLE

**Executive** style washrooms benefit from the high quality of the ultimate range, produced with flexibility of colour choice, design option and availability.

The **Executive** style represents a blend of materials, partitions and doors, produced using moisture resistant core V313 bonded with textured Melamine 19mm thickness. Colour, Silver grey, Magnolia or Polar White. All edges P.V.C lipped. Pillasters faced both sides with texture finished high pressure laminate. 20mm vertical facing edges post formed. Fixtures fittings and fixings high grade aluminium Satin Silver anodised finish.



Polar White partitions and doors, pilaster vanity unit and light pelmet, Formica Bluestone 7957 CS



Indicator lock with Emergency access Aluminium with Silver Satin Anodised finish

### EXECUTIVE PILASTER, VANITY UNIT AND LIGHT PELMET COLOUR OPTIONS

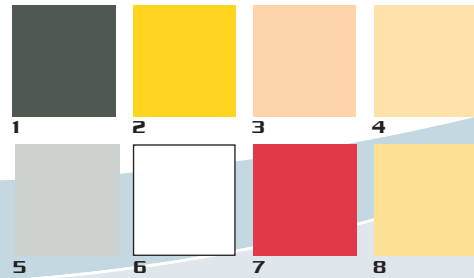

Cubicle with Half height framed duct panel system



Support Leg Aluminium Silver Satin Anodised finish

### COLOUR SELECTION

1. Storm 7912 CS
2. Spectrum Yellow 7940 CS
3. Lotus 3001 CS
4. Seringa 2273 CS
5. Folkstone 7927 CS
6. Polar white 2255 CS
7. Spectrum Red PP5582 CR
8. Peach 2288 CS

● Printed colours may vary from actual laminate. Laminate samples available on request



## Fast Fit Range

Illustrated is our standard Fast Fit Cubicle colour range with door colour options. Doors lipped with high impact PVC lipping, matching or contrasting colours as requested. The Fast Fit colour range available to our customers is virtually unlimited. Plain colour, wood grains or patterns can all be supplied subject to availability. Colours can be mixed to suit individual requirements. Fast Fit Range can be supplied with special laminated doors, colour to choice. Supplied with laminated or PVC lipped edges. Please contact our Sales Office for assistance.

## Budget Style

### COMMERCIAL - ROBUST - COMPETITIVE

- Factory prepared pre-drilled ready for assembly
- Moisture resistant melamine finish panels.
- High impact PVC edging to all edges.
- Corrosion resistant anodised aluminium furniture and fittings
- Choice of colour plus door colour options.
- Complete furniture, fittings and fixing pack.
- Low on-site assembly time
- Supplied complete ready to install
- Easy to order



One cubicle in left hand corner with matching vanity unit

## Contract Style

### MID RANGE - ROBUST - COMPETITIVE - DURABLE

- Factory prepared pre-drilled ready for assembly
- Moisture resistant Melamine finish panels
- Aluminium capped door all panels PVC edged
- Support foot with height adjustment
- Corrosion resistant anodised aluminium furniture and fittings
- Choice of colour plus door colour options.
- Complete furniture, fittings and fixing pack.
- Low on-site assembly time
- Supplied complete ready to install
- Easy to order



Two cubicles in right hand corner with matching vanity unit

### FAST FIT STOCK COLOURS

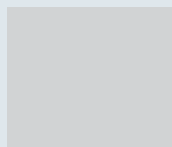

Silver Grey

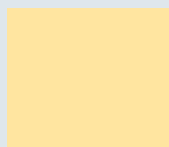

Magnolia

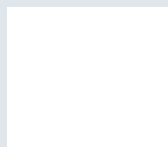

Artic White



Fast fit indicator Lock



Fast fit support foot

\*Printed colours may vary from actual laminate. Laminated samples available on request

**Fast Fit Range**

**Majestic Style**

**DECORATIVE FINISH - ROBUST - DURABLE**

- Factory prepared pre-drilled ready for assembly
- Moisture resistant Melamine finish panels
- Doors and Panels aluminium capped on all edges
- Support foot with height adjustment
- Corrosion resistant anodised aluminium furniture and fittings
- Choice of colour plus door colour options.
- Complete furniture, fittings and fixing pack.
- Low on-site assembly time
- Supplied complete ready to install
- Easy to order

**FAST FIT DOOR COLOUR OPTIONS**



Red



yellow



Blue



Two cubicle in left hand corner with matching vanity unit

**Budget/Contract/Majestic**

**MATCHING VANITY UNITS, FRAMED DUCTING SYSTEMS & WALL PANNELLING**



**STANDARD VANITY UNIT PROFILES**

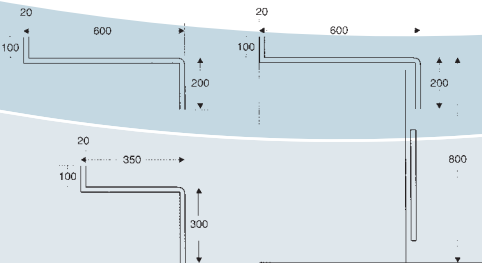

Vanity units and tops, laminate bonded to moisture resistant core. Unjointed length of 3000mm, virtually any size, colour of finish available made to order

## Premier Plus Range

**Premier Plus** is manufactured specifically for locations such as leisure Centres, manufacturing Clean Areas, Education and health facilities, Ministry of Defence Departments and similar establishments. These locations require an above average product range incorporating resistance to water, high humidity, sudden temperature change and vandalism, but incorporate easy clean qualities.

**Premier Plus** is a solid grade black resin 12mm core laminate, fabricated to produce W.C., Shower and Changing Cubicles, wall Panelling, Vanity Units Changing Lockers, etc. They are all supplied with specially designed heavy duty hardware, and Fixings.

**Premier Plus** Cubicles have been designed specifically for wet and humid areas, fabricated to withstand excessive abuse or vandalism. High impact 12mm thickness solid grade laminate surfaces and edges are impervious to cleaning chemicals, fungicide and bacteria and have hygienic maintainability. Most surface marks can be removed.

**Premier Plus** is a complete system incorporating specially designed heavy duty furniture, fittings and fixings. (Does not incorporate plastic or other materials that may lead to life expectancy being reduced).

**Premier Plus** is available as W.C, shower or changing cubicles, vanity units, shelves, wall panelling, modesty screens and changing lockers, to suit virtually any situation.



Shower cubicles with special size doors and hardware



Premier Plus support foot



Prestigious toilet cubicles and vanity units supplied to Southampton Football Club.



Emergency access indicator lock aluminium with stainless steel finish



Prestigious toilet cubicles and vanity units supplied to Southampton Football Club.

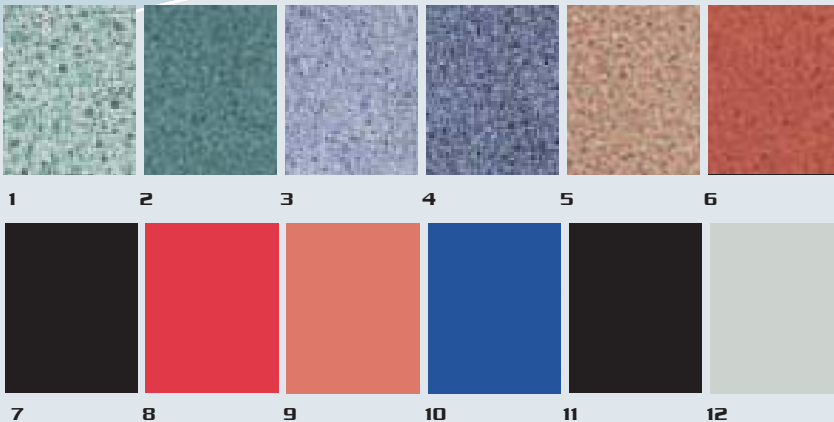

### COLOUR SELECTION

1. Cosmic vert Surf **CO31**
2. Nova Mousse Surf **NO28**
3. Nova Lilas Surf **NO22**
4. Nova Saphir Surf **NO23**
5. Cosmic Rose Surf **CJ32**
6. Nova Argile Surf **NO49**
7. Grafix Velour **&504**
8. Spectrum red **7845**
9. Un Coral **PP 1840**
10. Un Oceano **PP 1997**
11. Seringar Velour **2273**
12. Folkestone Velour **7927**

White - Subject to availability

● Printed colours may vary from actual laminate. Laminate samples available on request

**Toodle Loos Childrens Range**

**KALEIDOSCOPE STYLE**

**Kaleidoscope** free standing cubicles shown with self adhesive motifs and decals. Designed for locations where soft shapes and colours are required. Kaleidoscope style is supplied with bright colour options, single colour, mixed at random, or to customers choice from red, blue, yellow or green colour selection. **Kaleidoscope** style can also be supplied in plain silver grey, magnolia or white if required. Special attention has been given to rounding corners and edges where possible. Large slim door handle, self closing door hinges and door lock fitted to the inside only have been specially designed with small children in mind. **Kaleidoscope** style is supplied in two panel heights and depths of cubicle for small and not so small children and can be supplied to meet any design configuration. Supplied complete ready to install cubicles only or as a layout to include low level matching or contrasting vanity units and fitments.



Kaleidoscope free standing cubicles shown with self adhesive motifs and decals.



Kaleidoscope cubicles are supported using our robust Jumbo pedestal style leg, with silver satin anodised finish



Door hinge can be fitted to close, or if required, self open. Designed to clamp and through fix. Can be set for door to be lifted off or permanently fixed. Set clear of pilaster, therefore avoiding trapped fingers



**TINY TOTS STYLE**

**Tiny Tots** cubicles and low level vanity units have been designed specifically for areas of high usage or situations where robust but competitively priced cubicles are required. Available as a standard size and is produced specifically for little children. Full height partions and facing panels, half height doors finished with smooth corners and edges, colour options available are silver grey, magnolia or arctic white as single or mixed colours. **Tiny Tots** style can also be supplied with door colour options of red, yellow or green if required.

Large slimline door handles, self closing door hinges and lock fitted to the inside only have been designed with small children in mind. Supplied complete ready to install. Cubicles only or as a layout to include low level matching or contrasting vanity units.



Tiny Tots free standing cubicle with vanity unit shown with self adhesive motifs and decals



vanity Units are available for little children and adults. Manufactured using moisture resistant core, bonded with high pressure laminate and post formed to produce smooth shaped tops and frame with lift off access panels underneath. Supplied in matching or contrasting colours.



Kaleidoscope and Tiny Tots cubicles are supplied with large slimline door handles, positioned low to allow the smallest of children ease of access. Colour to choice

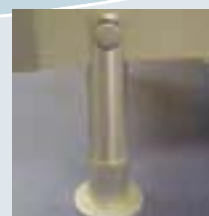

Tiny Tots style cubicles are supplied with a robust box style bolt through type support leg, with silver satin anodised finish.

**Trade Pack Range One Size Fits All Washrooms**

**TRADE PACK (CUBICLE IN A BOX)**

'One Size fits all' Washrooms have been designed to meet the requirements of a robust, low cost, easy to install system, that is demanded by today's contractors, and which is available from stock in your area.

Trade Pack washrooms are available in white only. Core material is moisture resistant but recommended for dry areas only.

**WHATS IN THE PACK**

- Supplied with all necessary fittings and fixings to complete the job
- Designed to be cut and fitted to a minimum and maximum width and depth
- Part of a complete washroom which can be mixed or matched to suit all applications

Olympus Washroom Systems

**PACK 1**  
Standard Heavy Duty Hardware Kit  
(Supplied Complete)

**PACK 2**  
Standard Door Kit

**PACK 3**  
Standard Partition Kit

**PACK 4**  
Vanity Frame Kit

**PACK 5**  
1 Metre Vanity Top Kit

**PACK 6**  
2 Metre Vanity Top Kit

**PACK 7**  
3 Metre Vanity Top Kit

**PACK 8**  
Lower Wall W.C. Kit

**PACK 9**  
Lower Wall Urinal Kit

**PACK 10**  
Upper Wall Kit

**PACK 11**  
Long Head Rail kit  
4000mm

**PACK 12**  
Additional Leg Kit

**PACK 13**  
Disabled Cubicle Headware  
(4 LEGS)



**Trade Pack Range One Size Fits All Washrooms**

**PACK 14**

Vanity End Panel Kit

Size: 570 x 780



**PACK 15**

Wall Unit End Panels

Size: 300 x 2400



**PACK 16**

Top Infill/Wall Scribes

Size: 300 x 2400

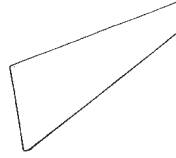

**PACK 17**

Special Panels required for full Size Disabled Cubicle

Size: 2000 x 1500 (order with Hardware Pack 13)

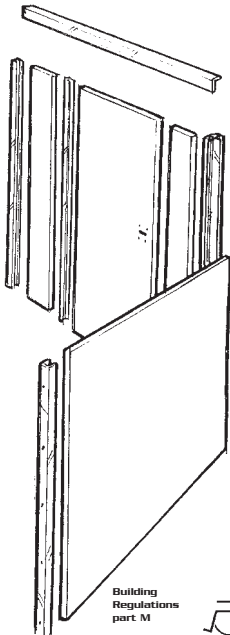

Building Regulations part M  
 MOBILITY CUBICLES

**TYPICAL INSTALLATION**

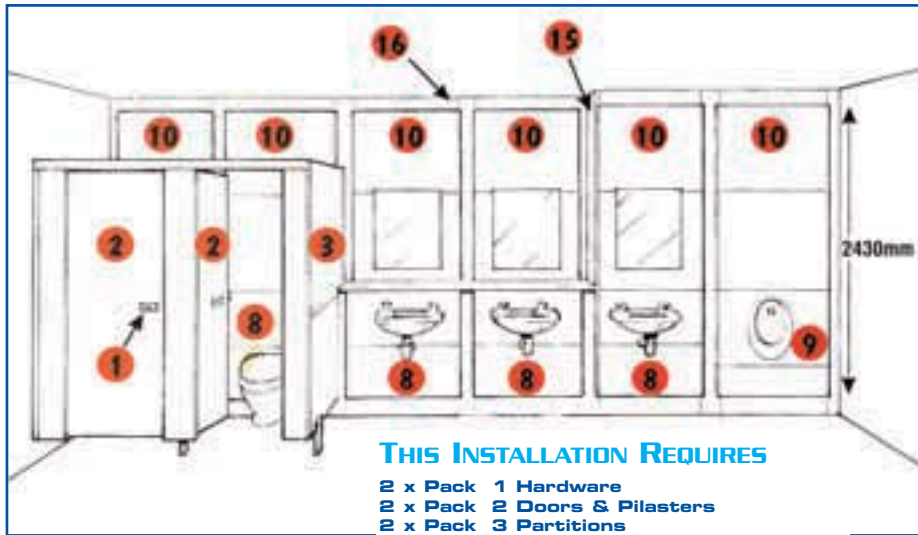

**THIS INSTALLATION REQUIRES**

- 2 x Pack 1 Hardware
- 2 x Pack 2 Doors & Pilasters
- 2 x Pack 3 Partitions
- 5 x Pack 8 Lower Wall W.C Kit
- 1 x Pack 9 Lower Wall Urinal Kit
- 6 x Pack 10 Upper Wall Kit
- 1 x Pack 15 End Panel
- 1 x Pack 16 Top Infill/Wall Scribe

**ONE MAN ASSEMBLY SYSTEM**

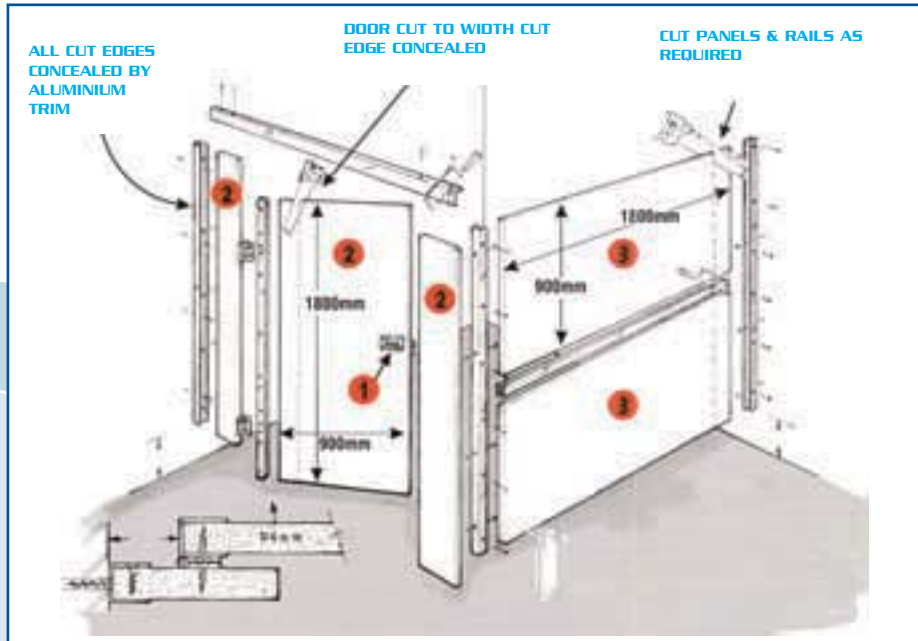

ALL CUT EDGES CONCEALED BY ALUMINIUM TRIM

DOOR CUT TO WIDTH CUT EDGE CONCEALED

CUT PANELS & RAILS AS REQUIRED



SEE OVER FOR PACK SELECTOR GUIDE TO CREATE CUBICLES, VANITY, AND DUCT PANELS SYSTEMS TO MEET YOUR REQUIREMENTS

**Trade Pack Range PACK SELECTOR GUIDE**

**CORNER CUBICLE**

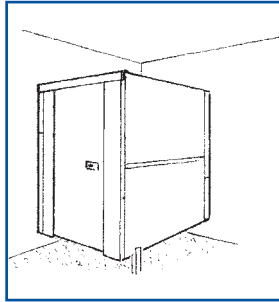

SIZES	Packs Required
W' MIN 750mm Max 1250mm D' MIN 1350mm Max 1900mm	1 x no.1 1 x no.2 1 x no.3

**SIDE ENTRY CUBICLE**

In a Corner

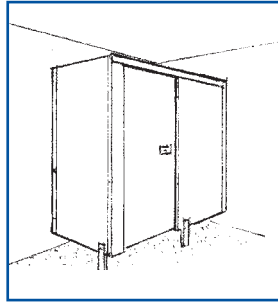

SIZES	Packs Required
W' MIN 750mm Max 900mm D' MIN 1350mm Max 1950mm	1 x no.1 1 x no.2 1 x no.3

**ALCOVE CUBICLE**

Between Walls

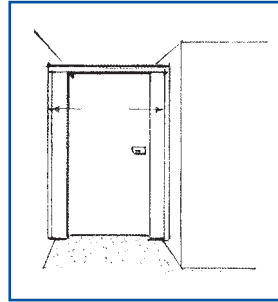

SIZES	Packs Required
W' MIN 750mm Max 1250mm Ensure Door Clears W.C. Pan	1 x no.1 1 x no.2

**WIDE ALCOVE CUBICLE**

In Line Between Walls

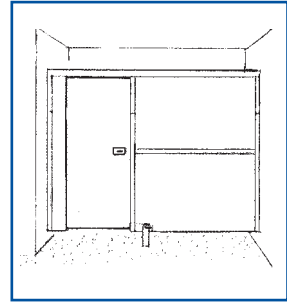

SIZES	Packs Required
W' MIN 1350mm Max 2850mm Ensure Door Clears W.C. Pan	1 x no.1 1 x no.2 1 x no.3

**RUN OF CUBICLES 3**

In a Left Hand Corner

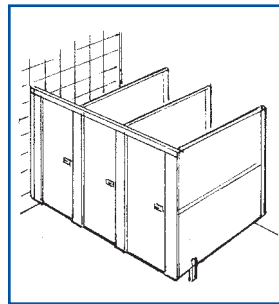

SIZES	Packs Required
W' MIN 2310mm Max 3350mm D' MIN 1350mm Max 1800mm	3 x no.1 3 x no.2 3 x no.3

**DISABLED CUBICLES**

Door Opens Outwards

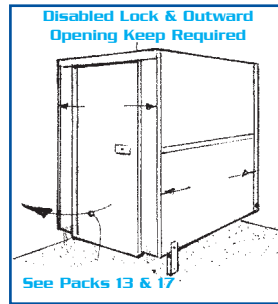

SIZES	Packs Required
W' MIN 750mm Max 1250mm D' MIN 1350mm Max 1800mm	1 x no.1 1 x no.2 1 x no.13

**SINGLE VANITY UNIT**

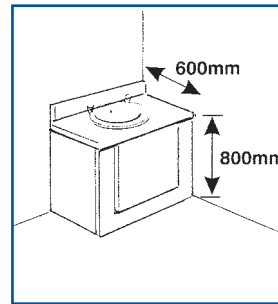

LENGTH	Packs Required
MIN 750mm MAX 1000mm	1 x no.4 1 x no.5

**DOUBLE VANITY UNIT**

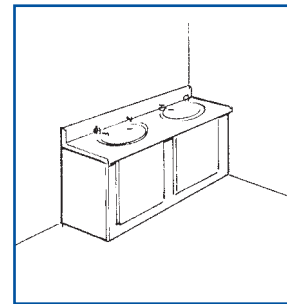

LENGTH	Packs Required
MIN 1500mm MAX 2000mm	2 x no.4 1 x no.6

**TRIPLE VANITY UNIT**

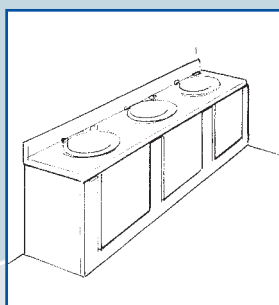

LENGTH	Packs Required
MIN 2250mm MAX 3000mm	3 x no.4 1 x no.7

**LOW WALL UNIT WC**

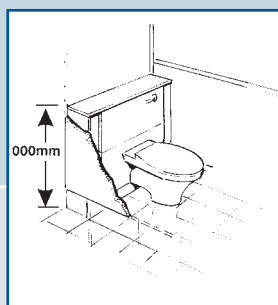

WIDTH	Packs Required
MIN 750mm width MAX 1000mm width	1 x no.8

**LOW WALL UNIT URINAL**

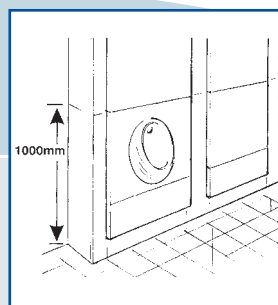

WIDTH	Packs Required
MIN 750mm width MAX 1000mm width	1 x no.9

**UPPER WALL UNIT**

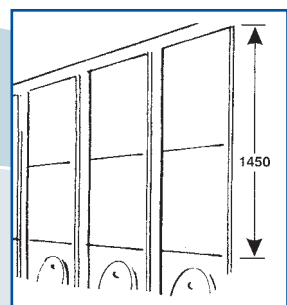

WIDTH	Packs Required
MIN 750mm width MAX 1000mm width	1 x no.10

CUT AND FIT TO THE SIZE REQUIRED

NO STUD WORK REQUIRED FOR WALL PANEL PACKS

ALL PANELS ARE COLOURED WHITE AND WITH A MOISTURE RESISTANT CORE

**Fairline Range**



S2327701 - 1/2" Basin Taps Chrome Head  
S2327601 - 1/2" Basin Taps Acrylic Head

S2327703 - 3/4" Bath Taps Chrome Head  
S2327603 - 3/4" Bath Taps Acrylic Head



S2327702 - 1/2" High Neck Sink Taps Chrome Head  
S2327602 - 1/2" High Neck Sink Taps Acrylic Head

S2327706 - 1/2" Basin Monobloc Mixer with Pop-up Waste Chrome Head

S2327604 - 1/2" Basin Monobloc Mixer with Pop-up Waste Acrylic Head



S2327704 - 3/4" Bath Shower Mixer with Kit Chrome Head

S2327706 - 1/2" Sink Monobloc Mixer Chrome Head  
S2327606 - 1/2" Sink Monobloc Mixer Acrylic Head

S2327605 - 3/4" Bath Shower Mixer with Kit Acrylic Head

Taps and Mixers

**Club Range**



S8080101 - Contract Acrylic Head Basin Taps

S8080102 - Contract Acrylic Head Bath Taps

S8080103 - Contract Acrylic Head High Neck Sink Taps

For Waste and Traps See Page 228-229

**Victorian Range**



S2331055 - Basin Taps Chrome  
S2331053 - Basin Taps Gold



S2331054 - Bath Taps Chrome  
S2331052 - Bath Taps Gold



S2331050 - Monobloc Basin Mixer With Pop up Waste Chrome

S2331051 - Monobloc Basin Mixer With Pop up Waste Gold



S2331056 - Bath Shower Mixer With Telephone Handset Chrome

S2331059 - Bath Shower Mixer With Telephone Handset Gold



S2331045 - Monobloc Bidet Mixer With Pop up Waste Chrome

S2331046 - Monobloc Bidet Mixer With Pop up Waste Gold

**B55 5412 Cross Head Range**



S2327011 - Basin Taps Chrome



S2327001 - Bath Taps Chrome



S2327501 - Sink Taps High Neck Chrome



S2327012 - Bath Shower Mixer With Hose Hand Set and Wall Bracket Chrome



S2327021 - Deck Sink Mixer 8" Spout Chrome



S2326001 - Hot Bib Tap Chrome  
S2326002 - Cold Bib Tap Chrome

For Waste and Traps See Page 228-229



**Jetline Range**



**S7002009** - Basin Taps Chrome (No Handles)



**S7002010** - Bath Taps Chrome (No Handles)



**S7002011** - Monobloc Basin Mixer with Pop Up Waste Chrome-Monoflow (No Handles)



**S7002012** - Monobloc Basin Mixer With Chain Waste Chrome-Monoflow (No Handles)



**S7002013** - Monobloc Basin Mixer With Pop Up Waste Chrome-Twin Flow (No Handles)



**S7002014** - Monobloc Basin Mixer With Chain Waste Chrome-Twinflow (No Handles)



**S7002007** - Bath Shower Mixer With Hose, Handset and Wall Bracket, Chrome (No Handles)



**S7002008** - Bath Filler Chrome (No Handles)

Taps and Mixers

**Handle Options (Specify Separately)**



**S7002015** - White Porcelain Handles  
**S7002016** - Cream Porcelain Handles  
**S7002017** - Old English White Porcelain Handles



**S7002018** - Chrome Cylindro Handles



**S7002040** - Acrylic Handles

For Waste and Traps See Page 228-229



**Waterways Range**



S7002001 - Basin Taps Chrome (No Handles)



S7002002 - Bath Taps Chrome (No Handles)



S7002003 - Monobloc Basin Mixer With Pop Up Waste Twinflow Chrome (No Handles)



S7002004 - Monobloc Basin Mixer With Chain waste Twinflow Chrome (No Handles)



S7002005 - Bath Filler Twinflow Chrome (No Handles)



S7002006 - Bath Shower Mixer With Hose Handspray and Wall Bracket Chrome (No Handles)

**Handle Options (Specify Separately)**



S7002015 - White Porcelain Handles



S7002018 - Chrome Cylindro Handles



S7002019 - Crystal Acrylic Handles

**Kingston Range**



S7002020 - Basin Taps Chrome

S7002021 - Basin Taps Gold



S7002022 - Bath Taps Chrome

S7002023 - Bath Taps Gold



S7002024 - Bath and Shower Mixer with Hose and Telephone Handset Chrome

S7002025 - Bath and Shower Mixer with Hose and Telephone Handset Gold

For Waste and Traps See Page 228-229

**Water Fittings**



**S2320011** - Nuastyle Anti Vandel Basin Taps Chrome



**S2320001** - Nuastyle Anti Vandel Bath Taps Chrome



**S2320501** - Nuastyle Anti Vandel High Neck Sink Taps Chrome



**S2330501** - Prestex 877 Non Concussive Basin Tap Hot - Chrome



**S2331001** - Prestex 876 Non Concussive Basin Tap Hot - Chrome



**S2331501** - Prestex 880 Non Concussive Bib Tap Hot - Chrome

**S2330502** - Prestex 877 Non Concussive Basin Tap Cold - Chrome

**S2331002** - Prestex 876 Non Concussive Basin Tap Cold - Chrome

**S2331502** - Prestex 880 Non Concussive Bib Tap Cold - Chrome



**S2331004** - Economy Non Concussive Basin Taps Chrome



**S2332001** - Mira Timed Flow Basin Tap Hot Chrome

**S2332002** - Mira Timed Flow Basin Tap Cold Chrome



**S2336201** - Thermostatic Mixing Valve Chrome, 15mm Inlets, 1/2" Outlet



**S2336202** - Isolation Kit A (for use with Thermostatic mixing Valve)



**S2336203** - Isolation Kit B (for use with Thermostatic mixing Valve)

**S2236211** - Thermostatic Mixing Valve Chrome, 22mm Inlets, 3/4" Outlet

For Waste and Traps See Page 228-229

Commercial Valves & Mixers

## Water Fittings

Electronic washroom system using a central control unit to manage the economic delivery of water to washbasins, showers, urinals and WCs.

- Water saving
- Each control unit operates up to 10 devices
- Easy to install
- Wide choice of fittings

Sensorflow washroom systems use an electronic central control unit to manage the economic delivery of water to washbasins, showers and urinals.

A separate system is available for WC flushing (see below). Washbasin spouts with integral infrared proximity sensors are pre-programmed to automatically prompt water flow and preferred run time. Alternatively, spouts or shower heads are available with separate sensors with a choice of run times. Infrared urinal sensors detect usage and initiate flushing.

Each unit can control up to 10 outlets in any combination of washbasins, showers or urinals and is simply extended by the addition of further control units. The system requires that washbasins and showers are fed by pre-mixed water from a conveniently sited thermostatic valve.

All sensors and control circuits operate on a safe 12 volts transformed from the mains supply and are supplied with detailed, easy to follow instructions.



### BASIN, URINAL AND SHOWER COMPONENTS

- S2331101 - (S8100) Programmable Control Unit (Operates up to 10 Sensors)
- S2331102 - (S8101) Basin Mounted Spout with Integral Proximity Sensor
- S2331103 - (S8102) Panel Mounted Spout with Integral Proximity Sensor
- S2331104 - (S8105) Surface Mounted Proximity Sensor
- S2331105 - (S8106) Panel Mounted Proximity Sensor
- S2331106 - (S8103) Basin Mounted Spout (For use with S8105 or S8106)
- S2331107 - (S8104) Panel Mounted Spout (For use with S8105 or S8106)
- S2331115 - (S8110) Short Projection. Shower Head with Surface Mounted Sensor
- S2331116 - (S8111) Short Projection. Shower Head with Panel Mounted Sensor
- S2331108 - (S8115) Panel Mounted Urinal Sensor
- S2331109 - (S8116) Surface Mounted Urinal Sensor

### W. C. FLUSHING COMPONENTS

- S2331110 - (S8120) Programmable Control Box for up to 3 WCs
- S2331111 - (S8125) Combined Actuator and Cistern Cover with Panel Mounted Sensor
- S2331112 - (S8126) Combined Actuator and Cistern Cover with Surface Mounted Sensor
- S2331113 - Conceala Low Level Concealed Cistern and Fittings

WC Sensors can only be used with 'Conceala' cisterns.

For Thermostatic Mixing Valves See Page 183

## Water Fittings

### HOW DOES THE SYSTEM WORK?

#### FOR WASHBASINS

The sensor detects the presence of hands and delivers water whilst they are present, up to a maximum of 2 minutes. Water flow will stop 4 seconds after hands are removed. For showers and spouts with remote sensors a run time can be chosen of between 7 and 20 seconds or between 30 seconds and 2 minutes, which can be interrupted by a second sensor activation.

#### FOR WALL URINAL FLUSHING

The sensor positioned above the urinal detects usage. There is then the option of choosing the type of frequency of the flush. Frequency can be following every visit or every 30 minutes (assuming the urinal has been used, ie sensor activated for a maximum of 6 seconds). Method of flush can be via a conventional automatic cistern, storage cistern or mains supply. Flushing using an automatic cistern dispenses 4.5 litres every flush. From storage or mains, a timed flow of water is selected.

#### FOR WC FLUSHING,

A wall or panel mounted sensor detects the close proximity of hands which initiates the flush of the WC. A pre-programmed separate unit controls up to 3 WCs. The actuator is supplied complete with cistern cover suitable for the Conceala cistern only.

**Note:** This product can be installed in full compliance with UK Water Regulations.



Sensorflow Range

For Thermostatic Mixing Valves See Page 183



## Water Fittings

An electronic water control system for use with a single outlet. Chrome Plated and supplied complete with all necessary components.

- Water saving
- Cost saving
- Hygienic
- Easy clean

### MODES OF OPERATION

Spouts with integral sensors detect hands within the sensing range and the solenoid valve is opened. The valve remains open for 5 seconds after the removal of hands and up to a maximum of 30 seconds if a hand or object is continuously detected. Spouts with remote sensors operate differently. When hands are detected within close proximity of the sensor, the solenoid valve opens and water is delivered for a maximum of 30 seconds. The solenoid valve can be closed within this period by a second activation of the sensor.



S2331117 - (S8135AA) High Rise Washbasin Mounted Spout with Integral sensor, Control Unit and Solenoid Valve Chrome Finish



S2331118 - (S8136AA) Cast Panel Mounted Spout with Integral Sensor, Control Unit and Solenoid Valve Chrome Finish

S2331119 - (S8137AA) Cast Panel Mounted Spout with Remote Panel Sensor, Control Unit and Solenoid Valve Chrome Finish

For Thermostatic Mixing Valves See Page 183



**Water Fittings**



**S2186702 - 'NC1' Stainless Steel Wall Mounted Drinking Fountain with Self Closing Valve and Waste 32mm**



**S2186101 - White Vitrous China Drinking Fountain with Self Closing Valve and Waste 32mm.**



**S2186501 - 'Puro' Drinking Fountain with Shrowded Jet and Rotating Handwheel. Chrome.**



**S2186502 - 'Puro' School Pattern Drinking Fountain with Supply and Waste Pipes to Wall and Fixing Brackets. Chrome**



**S2187301 - 'Puro' Pedestal Drinking Fountain. Supply and waste Pipes Concealed within Galvanised Tubular Pedestal and Base.**



**S2187501 - Wall Mounted Eye Wash Fountain with Self Closing Valve. Chrome**



**S2186701 - 'Puraqua' Mark 2 Drinking Fountain. Stainless Steel with Toggle Action Valve.**



**S2186703 - 'Purita' Stainless Steel Wall Mounted Drinking Fountain with Push Button Self Closing Valve and Waste 32mm.**



**S2186704 - 'Purita' Stainless Steel Drinking Fountain as Previous But with Wall Fixed Floor Standing Pedestal.**

For Traps See Page 229

## Macerators and Pumps



### SANIFLO SYSTEM

A water pressure activated macerator and pump. For fixing to normal horizontal outlet closet. When flush handle is depressed, the flushing action of the water into 'Saniflo' automatically activates the unit and starts a shredding and pumping action. Organic effluent and paper are reduced to a slurry and pumped away through 22mm small bore pipework. Operating cycle 15-18 seconds. Once the waste is discharged, the pressure switch is deactivated until the next time the lever is depressed. Outlet may be connected to 22mm PVC pipework for discharge into soil stack and will operate on a minimal gravity of 1:200. Connection to suitable 220-225 volts main electrical supply. 500 watt induction motor is quiet and powerful and drives twin stainless blades and an impeller group.

S2185701 - Saniflo Macerator



### SANITOP SYSTEM

This a variation of the Saniflo system designed for use with toilets that are installed below ground level such as basements and cellars. Sanitop will lift WC effluent directly vertically a distance of 1.5 metres to 4 metres. Outlet may be connected to 22mm PVC pipework for discharge into soil stack. Connection to suitable 220-250 volt mains electrical supply.

S2185711 - Sanitop Macerator



### SANIPRO SYSTEM

Sanipro is an ideal way to install an en-suite shower room, enabling, for example, a large bedroom to be improved with en-suite facilities.

It is easy and economical to install and can be concealed behind a demountable panel to give access if required.

As with all Saniflo products, the Sanipro is backed by the Saniflo Two Year Guarantee of Quality.

S2185732 - Sanipro Macerator

## Macerators and Pumps



### SANIVITE SYSTEM

Sanivite is specially designed to deal with the hot soapy pumped waste water from dishwasher or washing machine, making the addition of a domestic kitchen or utility room easy even when below or distant from a drain.

Sanivite is a powerful pump with four inlets for connection to sink or appliances.

Waste water is pumped through 32mm small-bore pipework, vertically up to 5 metres or horizontally up to 50 metres or a lesser combination of both.

The compact Sanivite is usually concealed in a kitchen unit but can also be concealed behind a demountable panel to give access if required.

S2185731 - Sanivite Pump Unit



### SANIPLUS SYSTEM

This macerator is fitted to the closet in the same way as the Saniflo, but has provision to accept waste water discharge from the bath, wash basin, shower or bidet. It can be used to discharge effluent either 4 metres vertically or from 20-25 metres horizontally with minimal gravity fall. Outlet may be connected to 32mm PVC pipework for discharge into soil stack. Connection to suitable 220-250 volt mains electrical supply. 650 watt induction motor drives twin stainless steel blades and an impeller pump.

S2185721 - Saniplus Macerator



### SANISHOWER SYSTEM

Sanishower is especially useful where a shower or wash basin is to be sited in a place where gravity drainage will be difficult or impossible to run, for example in a basement or on an internal wall of a property.

Sanishower can be installed next to or underneath a shower tray with access.

S2185733 - Sanishower Macerator

# Saniflo Range

## Aridian Waterless Urinal Exposed

Vitreous china waterless bowl urinal with exposed outlet and special cartridge. Saves water. Can reduce maintenance costs. Easy to install and requires no cistern or flushpipe.

- Exposed outlet
- Water saving (236,000 litres PA)
- Cost saving
- Easy clean design

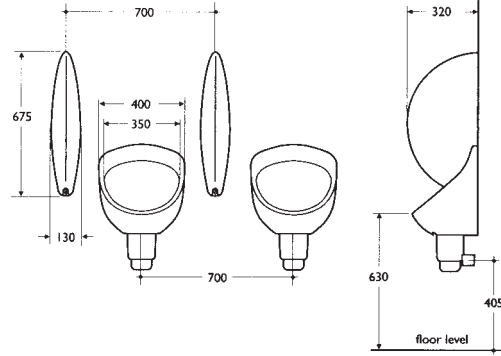

- S2160001 - 'Aridian' Waterless Urinal Bowl with Cartridge, Hangers and Outlet Adaptor.
- S2160002 - Replacement Cartridges
- S2160003 - Box of Replacement Cartridges (32 per box)

Outlet plain 41mm OD tube to push connect to polypropylene wastepipe to BS 5254.  
 Cartridge lasts for approximately 7,000 uses.  
 Minimum recommended duct depth 10cm.  
 Estimated saving per bowl, per year based on conventional urinal flushing of 4.5 litres, 6 times per hour, 24 hours per day, 365 days per year

## Aridian Waterless Urinal Concealed

Vitreous china waterless bowl urinal with concealed outlet and special cartridge. Saves water. Can reduce maintenance costs. Easy to install and requires no cistern or flushpipe.

- Concealed outlet
- Anti vandal concealed fixing
- Water saving (236,000 litres PA)
- Cost saving
- Easy clean design

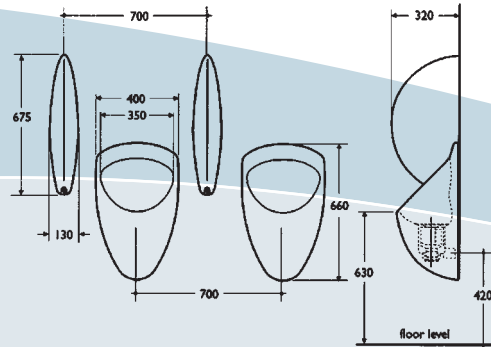

- S2160004 - 'Aridian' Waterless Urinal Bowl with Cartridge, Hangers and Outlet Adaptor.
- S2160002 - Replacement Cartridges
- S2160003 - Box of Replacement Cartridges (32 per box)

Outlet plain 41mm OD tube to push connect to polypropylene wastepipe to BS 5254.  
 Cartridge lasts for approximately 7,000 uses.  
 Minimum recommended duct depth 10cm. When fitting on panel the bottom access panel should be a maximum of 20cm in height.  
 Estimated saving per bowl, per year based on conventional urinal flushing of 4.5 litres, 6 times per hour, 24 hours per day, 365 days per year



## Fireclay Slab Urinal

Traditional fireclay slab urinals designed to suit varying site requirements including fitting to 2 or more adjacent walls.

Available with exposed or concealed flushpipes, with or without divisions.

- Slab urinal in fireclay
- Traditional style
- Optional divisions
- To special order only

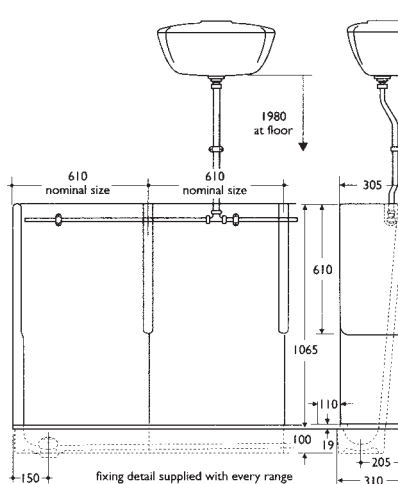

Channels and 2 1/2" strainer waste inclusive. When ordering, state overall length of urinal range and give full information with proposed outlet positions, glazing of return ends and detailed sketch.

- S2190001 - 1220mm Fireclay Slab Urinal Complete L/H Outlet Exposed Pipework
- S2190002 - 1220mm Fireclay Slab Urinal Complete R/H Outlet Exposed Pipework

## GRP Trough Urinal

### WALL FIXING.

Manufactured from glass fibre reinforced polyester. Durable and light in weight.

### COMPRISING:

- One piece urinal trough.
- Plastic automatic cistern.
- Polished stainless steel supply pipes for exposed fixing CP button spreaders.
- Domical outlet grating 65mm BSP.
- Centre outlet. Colour: White

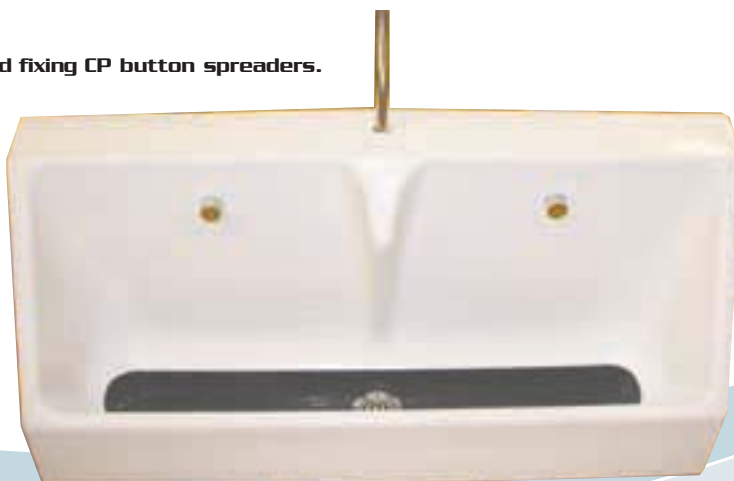

### STANDARD SIZES:

- Two person: 1220mm wide
- Three person: 1830mm wide

### DIMENSIONS:

- A = 1220/1830mm
- B = 610mm
- C = 270mm
- D = 200mm
- E = 400mm
- F = 155mm
- G = 180mm
- H = 300mm

- S2192001 - 1220mm Trough Urinal Complete
- S2192011 - 1830mm Trough Urinal Complete

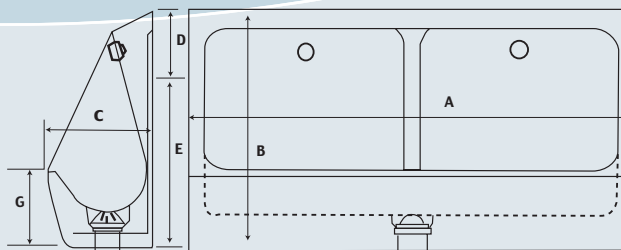

For Stainless Steel Urinals See Page 247-248



**Pipes and Fittings**

**EXPOSED PIPES AND SPREADERS**



Polished stainless steel pipes. CP top inlet spreaders.

- S2195001 - Set for Single Bowl
- S2195011 - Set for Range of 2 Bowls
- S2195021 - Set for Range of 3 Bowls
- S2195031 - Set for Range of 4 Bowls

**CONCEALED PIPES AND SPREADERS**

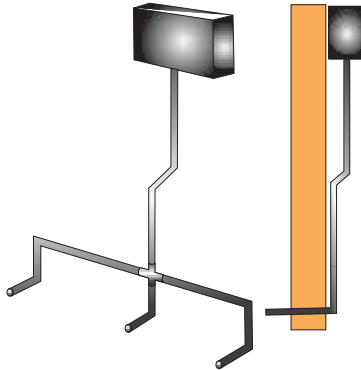

Unpolished stainless steel pipes. CP back entry button spreaders.

- S2195501 - Set for Single Bowl
- S2195511 - Set for Range of 2 Bowls
- S2195521 - Set for Range of 3 Bowls
- S2195531 - Set for Range of 4 Bowls

**CISTERMISER AUTOMATIC FLUSH CONTROL**

Regulates the water supply to automatic cisterns and prevents unnecessary wastage of water when urinals are out of use. Cost saving benefit where the water supply is metered. The valve has an important function, in that it complies with the Water Byelaw which states that automatic cisterns in mens' toilets should be fitted with a time switch or a device for ensuring that cisterns will operate only within such hours as the toilets are in general use. It is recommended that it is fitted down stream of the disc fitting to comply with the requirements of most water companies. One cistermiser can save up to 100,000 gallons of water in one year. It is non-electric and easy to instal. Connections: 13mm BSP female

**Two models:**  
**Standard valve** for mains pressure or cistern fed exceeding 5 metre head.  
**Low pressure valve** for cistern fed supply 0.5 to 5 metre head.

**SPARGE PIPE SETS**

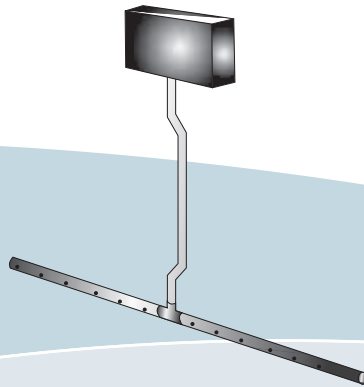

Exposed fixing for slab urinals.

**COMPRISING:**  
 Down pipe and holderbat. Perforated horizontal sparge pipe in two pieces. Centre tee piece and fixing brackets. Polished stainless steel

- S2199051 - Set for slab Urinal 1200mm
- S2199052 - Set for Slab Urinal 1800mm
- S2199053 - Set for Slab Urinal 2400mm
- S2199054 - Set for Slab Urinal 3000mm

For Automatic Urinal Cisterns See Page 143-144

**FLUTED URINAL TREADS**



Supplied as loose tiles.

- S2199001 - Size 150 x 150mm Finish Black

**PLAIN URINAL TREADS**



Supplied as loose tiles.

- S2199002 - Size 150 x 150mm Finish Black

**LOW PRESSURE VALVE**



S2199042 - Low Pressure Valve 0.5m - 5m Head

**STANDARD VALVE**



S2199041 - Standard Valve Over 5m Head

## Pipes and Fittings

### URINAL FITTINGS

In addition to the complete sets of pipes we supply with our slab urinals and ranges of bowls we also stock the following range of fittings and spares. This provides a quick service to builders who may be required to replace pipework to existing urinals, or for the fabrication of pipes in special situations, i.e. where the cistern cannot be fitted centrally above the urinal range.

### PERFORATED SPARGE PIPE



Polished stainless steel. Capped both ends.

- S2199061 - 1200mm x 15mm
- S2199062 - 1800mm x 15mm
- S2199063 - 2400mm x 22mm

### HORIZONTAL DISTRIBUTING PIPES



Polished stainless steel

- S2199071 - 600mm x 15mm

### DROP PIPES



Polished stainless steel

- S2199072 - 340mm x 15mm

### DOWN PIPE



Polished stainless steel

- S2199082 - 22mm with coupling nut. For bowl urinals

### DOWN PIPE



Polished stainless steel

- S2199081 - 22mm with Coupling Nut. For Slab Urinals

### TEE PIECE EQUAL



- S2199501 - 22mm Finish Chrome

### TEE PIECE UNEQUAL



- S2199502 - 22 x 15 x 15mm Finish Chrome

### CROSS PIECE



- S2199503 - 22 x 15 x 15 x 15mm Finish Chrome

### ELBOW 90 DEGREE



- S2199504 - 15 x 15mm Finish Chrome

### SADDLE CLIP



- S.2199511 - 22mm Finish Chrome
- S.2199512 - 15mm Finish Chrome

### TWO PIECE RING CLIP



- S2199521 - 22mm Finish Chrome
- S2199522 - 15mm Finish Chrome

### TOP INLET SPREADER



- S2199531 - Centre Screw Hole Fixing. O ring Connection 13mm Finish Chrome

### BACK INLET SPREADER



- S2199532 - Screwed Tail 13mm BSP Finish Chrome

### AUTOMATIC SYPHONS



All with 25mm BSP outlets

- S2199571 - 4.5 Litre
- S2199572 - 9.0 Litre
- S2199573 - 13.5 Litre
- S2199574 - 18 Litre

For Urinal Traps and Wastes See Page 228-229

**Cleaners and Belfast Sinks**

**BELFAST SINK**

Sink with Centre end outlet and weir overflow. A hardwood pad can be fitted to the front rim to give protection from scraping by heavy buckets.



- S2200001 - 915 x 610 x 305mm
- S2200011 - 760 x 455 x 255mm
- S2200021 - 610 x 455 x 255mm
- S2200031 - 610 x 455 x 205mm
- S2200041 - 455 x 380 x 205mm

**SHELF SINK**

Integral ledge with tapholes and soap tray. Taps must be fitted with extended tails.



- S2201501 - 610 x 535 x 255mm

**EXTENSION TAILS**

- S2201511 - 13mm BSP Thread

**CANTILEVER SINK BRACKETS**

For building into brick work.  
Cast iron, painted finish.  
Pair comprises: 1 cranked, 1 plain bracket



- S2204001 - 455mm Projection
- S2204011 - 405mm Projection
- S2204021 - 355mm Projection

**CLEANERS SINK**

Bucket sink with hardwood pad on front rim. 150mm high back complete with hinged grating S/Steel. No overflow.



- S2202001 - 510 x 380 x 230mm
- S2202011 - 455 x 380 x 200mm

**CLEANERS SINK WITH HIGH BACK**

Generally the same specification as S2202001 but 305mm high back complete with hinged grating S/Steel. No overflow.  
Bib taps should be fitted with extension pieces.



- S2203001 - 510 x 380 x 230mm

**LEGS AND BEARERS FOR BELFAST SINKS**

Cast iron, painted finish 635mm high

- S2204501 - 405mm Projection
- S2204511 - 355mm Projection

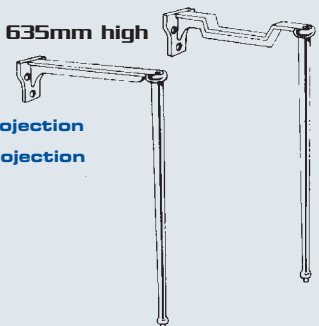

**LEGS AND BEARERS FOR CLEANERS SINK**

Cast iron, painted finish 305mm high

- S2205001 - 355mm Projection

For Wastes and Traps See Page 228-229

## Shower Trays



- S2220031** - 760x760mm Acrylic Capped Resin Stone Shower Tray - White
- S2220041** - 800x800mm Acrylic Capped Resin Stone Shower Tray - White
- S2220051** - 900x900mm Acrylic Capped Resin Stone Shower Tray - White



- S2220501** - 760x760mm Fireclay Heavy Duty Shower Tray no Overflow - White
- S2220502** - 820x820mm Fireclay Heavy Duty Shower Tray no Overflow - White



- S7002029** - 760x760mm Acrylic Shower Tray with 4 Tiling Upstands Complete with Front and End Panels Plus 38mm Strainer Waste - White
- S7002037** - 800x800mm Acrylic Shower Tray with 4 Tiling Upstands Complete with Front and End Panels Plus 38mm Strainer Waste - White
- S7002038** - 900x900mm Acrylic Shower Tray with 4 Tiling Upstands Complete with Front and End Panels Plus 38mm Strainer Waste - White
- S7002039** - 1200x750mm Acrylic Shower Tray with 4 Tiling Upstands Complete with Front and End Panels Plus 38mm Strainer Waste - White



- S2220061** - 900x900mm Quadrant Resin Stone Shower Tray - White.
- S2220071** - 800x800mm Quadrant Resin Stone Shower Tray - White.



- S2220081** - 800x800mm 'Space' Corner Shower Tray, Resin Stone with Internal Upstands and 38mm Strainer Waste - White.

Showering

For Wastes and Traps See Page 228-229

## Olympus Star Range Shower Enclosures

### STAR R QUADRANT



- S6100100 - Quadrant Shower Enclosure 900mm White Frame/Clear Glass
- S6100101 - Quadrant Shower Enclosure 900mm Silver Frame/Clear Glass
- S6100102 - Quadrant Shower Enclosure 800mm White Frame/Clear Glass
- S6100103 - Quadrant Shower Enclosure 800mm Silver Frame/Clear Glass

### STAR G PIVOT DOOR



### STAR A CORNER ENTRY



- S6100104 - Corner Entry Shower Enclosure 720 - 780mm White Frame/Clear Glass
- S6100105 - Corner Entry Shower Enclosure 720 - 780mm Silver Frame/Clear Glass
- S6100106 - Corner Entry Shower Enclosure 780 - 840mm White Frame/Clear Glass
- S6100107 - Corner Entry Shower Enclosure 780 - 840mm Silver Frame/Clear Glass
- S6100108 - Corner Entry Shower Enclosure 840 - 900mm White Frame/Clear Glass
- S6100109 - Corner Entry Shower Enclosure 840 - 900mm Silver Frame/Clear Glass

The Olympus Star Range of enclosures is stocked with the option of white or silver frame and clear glass.

See Page 197 for glazing patterns and frame colours which are available to order.

- S6100110 - Pivot Door 720-780mm White/Clear
- S6100111 - Pivot Door 720-780mm Silver/Clear
- S6100112 - Pivot Door 780-840mm White/Clear
- S6100113 - Pivot Door 780-840mm Silver/Clear
- S6100114 - Pivot Door 840-900mm White/Clear
- S6100115 - Pivot Door 840-900mm Silver/Clear  
(Reversible left/right hand opening)



**Olympus Star Range Shower Enclosures**

**STAR S INFOLD DOOR**



**STAR F SIDE PANEL**



- S6100116 - Infold Door 720 - 780mm White/Clear
- S6100117 - Infold Door 720 - 780mm Silver/Clear
- S6100118 - Infold Door 780 - 840mm White/Clear
- S6100119 - Infold Door 780 - 840mm Silver/Clear

- S6100120 - Side Panel 720 - 780mm White/Clear
- S6100121 - Side Panel 720 - 780mm Silver/Clear
- S6100122 - Side Panel 780 - 840mm White/Clear
- S6100123 - Side Panel 780 - 840mm Silver/Clear
- S6100124 - Side Panel 840 - 900mm White/Clear
- S6100125 - Side Panel 840 - 900mm Silver/Clear

Please note all stocked enclosures. Panels and doors are 185cm high. Special sizes available to order.

**GLAZING PATTERNS TO SPECIAL ORDER**



**Satin      Obscure      Frost Printed      Star Printed      Victorian**

**FRAME COLOURS TO SPECIAL ORDER**

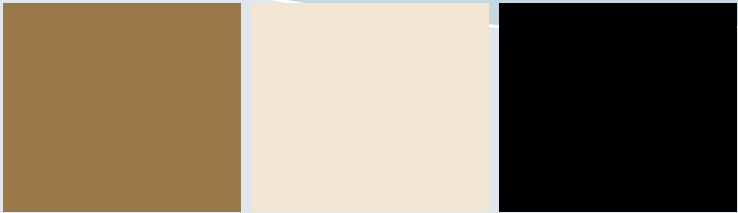

**Gold      Cream      Black**

For Shower Valves See Page 204-209

**Showering**

Chiara Range Shower Enclosures



S6100126 - 900mm Quadrant Shower Enclosure White Frame/Clear Glass



- S6100127 - 760mm Pivot Door White/Clear
- S6100128 - 760mm Pivot Door Polished Silver/Clear
- S6100129 - 800mm Pivot Door White/Clear
- S6100130 - 800mm Pivot Door Polished Silver/Clear
- S6100131 - 900mm Pivot Door White/Clear
- S6100132 - 900mm Pivot Door Polished Silver/Clear



- S6100133 - 760mm Corner Entry Cubicle White/Clear
- S6100134 - 760mm Corner Entry Cubicle Polished Silver/Clear

Add cubicle spacer pack to create 800mm corner entry shower enclosure.

To create 800mm doors and cubicles where not available use the following.



- S6100135 - 760mm Bifold Door White/Clear
- S6100136 - 760mm Bifold Door Polished Silver/Clear
- S6100137 - 900mm Bifold Door White/Clear
- S6100138 - 900mm Bifold Door Polished Silver/Clear

Add door spacer pack to create 800mm Bifold Door



- S6100139 - 760mm Side Panel White/Clear
- S6100140 - 760mm Side Panel Polished Silver/Clear
- S6100141 - 900mm Side Panel White/Clear
- S6100142 - 900mm Side Panel Polished Silver/Clear

Add cubicle spacer pack to 760mm side panel to create 800mm cubicle shower enclosure



- S6100143 - 1200mm Sliding Door White/Clear
- S6100144 - 1200mm Sliding Door Polished Silver/Clear

Use S6100139/40 Side Panel to Create Cubicle as illustrated

ALTERNATIVE GLAZING PATTERNS



Ocean Surf



Victorian



Art Deco

ALTERNATIVE FRAME COLOUR



Polished Gold

For Shower Valves See Page 204-209

Showering

## Calista Range Shower Cubicles

### CALISTA CONTOUR CORNER SHOWER ENCLOSURE 1215 X 930MM



- Corner enclosure with curvaceous hinged door and front panel in clear glass
- Curved unframed side panel in clear or green glass
- Handle options in clear glass or chrome
- Reversible outward opening door

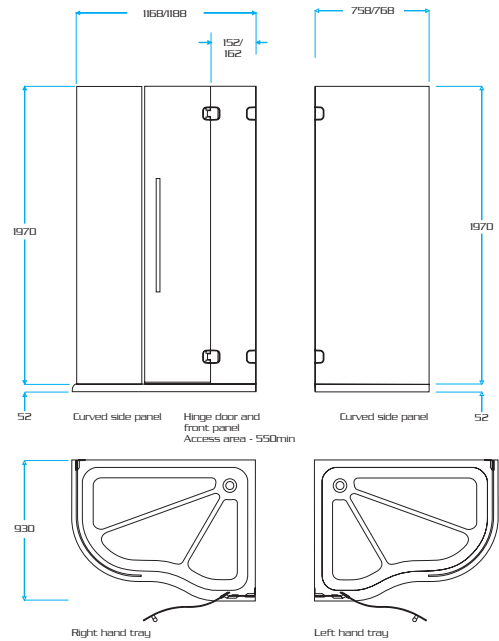

**S6100149** - Enclosure Clear Glass Hinged Door and Front Panel, Clear Curved Side Panel. Chrome Fittings.

**S6100150** - Enclosure Clear Glass Hinged Door and Front Panel, Green Curved Side Panel. Chrome Fittings.

(‘Calista’ door handles ordered separately See Page 201)

Showering



**S6100151** - 1215x930mm ‘Calista’ Contour Resin Stone Shower Tray Right Hand No Upstands - White

**S6100152** - 1215x930mm ‘Calista’ Contour Resin Stone Shower Tray Right Hand No Upstands - Grey Granite

**S6100153** - 1215x930mm ‘Calista’ Contour Resin Stone Shower Tray Left Hand No Upstands - White

**S61001540** - 1215x930mm ‘Calista’ Contour Resin Stone Shower Tray Left Hand No Upstands - Grey Granite

Calista Contour shower trays are available with 2 upstands if required.

**Calista Range Shower Cubicles**

**CALISTA CORNER SHOWER ENCLOSURE 800MM, 900MM OR 1000MM**



- Two sided corner enclosure with curvaceous Hinged door in clear glass
- Slim front panel in clear or green glass
- Handle options clear glass or chrome
- Outward opening reversible door

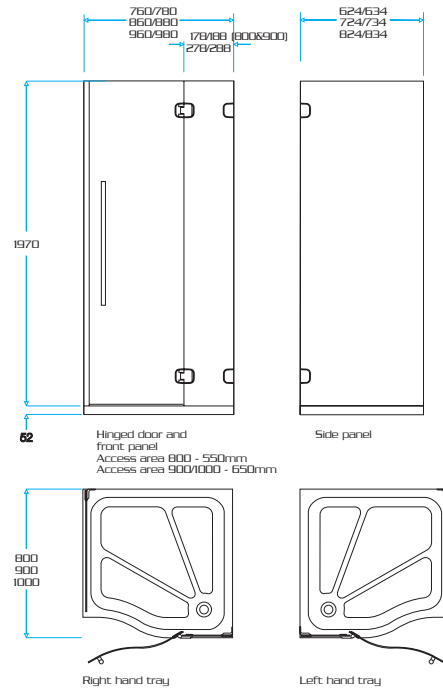

- S6100155 - 800mm Clear Glass Hinged Door With Clear Glass Front Panel**
- S6100156 - 900mm Clear Glass Hinged Door With Clear Glass Front Panel**
- S6100157 - 1000mm Clear Glass Hinged Door With Clear Glass Front Panel**
- S6100158 - 800mm Clear Glass Hinged Door With Green Glass Front Panel**
- S6100159 - 900mm Clear Glass Hinged Door With Green Glass Front Panel**
- S6100160 - 1000mm Clear Glass Hinged Door With Green Glass Front Panel**

(\*Calista' door handles ordered separately See Page 201)

- S6100161 - 800mm Side Panel Clear Glass**
- S6100162 - 900mm Side Panel Clear Glass**
- S6100163 - 1000mm Side Panel Clear Glass**
- S6100164 - 800mm Side Panel Green Glass**
- S6100165 - 900mm Side Panel Green Glass**
- S6100166 - 1000mm Side Panel Green Glass**

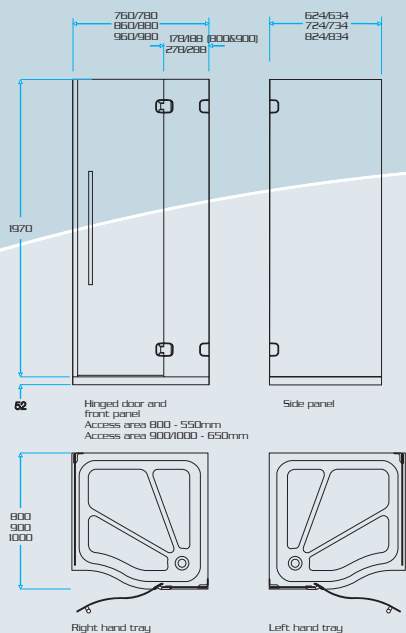

For Shower Tray and Column Mixer See Page 202

## Calista Range Shower Cubicles

### 'CALISTA' ALCOVE ENCLOSURE 800MM, 900MM, 1000MM



- Curvaceous hinged door and front panel for between wall fixing only
- Slim front panel in clear or green glass
- Handle options clear glass or chrome
- Reversible outward opening clear glass door

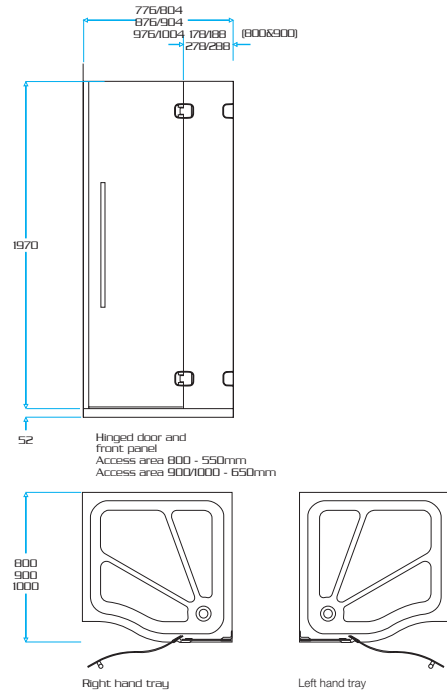

- S6100167** - 800mm Alcove Clear Glass Door with Clear Glass Front Panel
- S6100168** - 900mm Alcove Clear Glass Door with Clear Glass Front Panel
- S6100169** - 1000mm Alcove Clear Glass Door with Clear Glass Front Panel
- S6100170** - 800mm Alcove Clear Glass Door with Green Glass Front Panel
- S6100171** - 900mm Alcove Clear Glass Door with Green Glass Front Panel
- S6100172** - 1000mm Alcove Clear Glass Door with Green Glass Front Panel

(Calista door handles ordered separately)

#### HANDLE OPTIONS

##### CHROME PLATED



**S6100173** - Chrome Plated 'Calista' Door Handle

##### CLEAR GLASS



**S6100174** - Clear Glass 'Calista' Door Handle

For Shower Tray and Column Mixer See Page 202

Showering



### Calista Trays



- S6100175 - 800mm Resin Stone Tray Right Hand White
- S6100176 - 900mm Resin Stone Tray Right Hand White
- S6100177 - 1000mm Resin Stone Tray Right Hand White
- S6100178 - 800mm Resin Stone Tray Right Hand Grey Granite
- S6100179 - 900mm Resin Stone Tray Right Hand Grey Granite
- S6100180 - 1000mm Resin Stone Tray Right Hand Grey Granite

- S6100181 - 800mm Resin Stone Tray Left Hand White
- S6100182 - 900mm Resin Stone Tray Left Hand White
- S6100183 - 1000mm Resin Stone Tray Left Hand White
- S6100184 - 800mm Resin Stone Tray Left Hand Grey Granite
- S6100185 - 900mm Resin Stone Tray Left Hand Grey Granite
- S6100186 - 1000mm Resin Stone Tray Left Hand Grey Granite

All trays listed above have no upstands. They are available to special order with 2 or 3 upstands if required.

### Calista Valves



- Hydromassage shower column
- Design coordinated with trays and enclosures
- Chrome fittings
- Six built in body jets
- Foot jet
- 3 Function power shower head

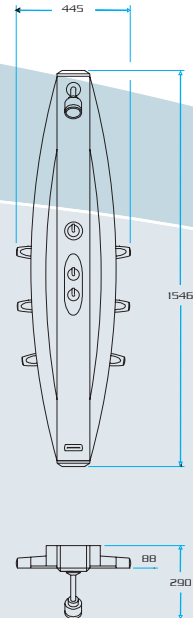

S6100187 - Shower Column White Finish Chrome Fittings

S6100188 - Shower Column Grey Granite Finish Chrome Fittings

Calista shower columns are suitable for high pressure installations only. Check with installer if your system requires an additional pump.

**Trevi Bath Screens**



Silver frame with art deco glass illustrated

**S6100189** - 135x80cm Chiara Curved Top Hinged Bath Screen White Frame Clear Glass

**S6100190** - 135x80cm Chiara Curved Top Hinged Bath Screen Polished Silver Frame Clear Glass



**S6100191** - Tribune 5 Panel Folding Bath Screen 130x104cm White Frame Clear Glass

**S6100192** - Tribune 5 Panel Folding Bath Screen 130x104cm Polished Silver Frame Clear Glass

**ALTERNATIVE GLAZING PATTERNS**

**ALTERNATIVE FRAME COLOUR**



Victorian



Art Deco



Polished Gold

**Olympus Bath Screens**



**S6100193** - 150x75cm 'Aurora 1' Curved Top Hinged Bath Screen White Frame Clear Glass

**S6100194** - 150x75cm 'Aurora 1' Curved Top Hinged Bath Screen Silver Frame Clear Glass

**S6100195** - 150x80cm 'Aurora 1' Curved Top Hinged Bath Screen White Frame Clear Glass

**S6100196** - 150x80cm 'Aurora 1' Curved Top Hinged Bath Screen Silver Frame Clear Glass



**S6100197** - 150x120cm 'Aurora 2' 2 Section Curved Top Hinged Bath Screen White Frame Clear Glass

**S6100198** - 150x120cm 'Aurora 2' 2 Section Curved Top Hinged Bath Screen Silver Frame Clear Glass



**S6100199** - 150x30cm 'Aurora 6' Fixed Reversible Bath Screen White Frame Clear Glass

**S6100200** - 150x30cm 'Aurora 6' Fixed Reversible Bath Screen Silver Frame Clear Glass

**GLAZING PATTERNS TO ORDER**

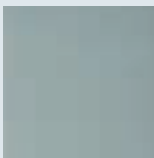

Satin



Obscure



Frost Printed



Star Printed



Victorian

**FRAME COLOURS TO ORDER**



Gold



Cream

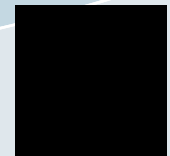

Black

Showering

**Triton Electric Showers**

**TRITON T300 Si**



- Flush fitting control panel
- Remote power pack
- Push button start/stop with phased shutdown
- Numbered temperature dial for easy temperature selection
- Push button power selector. Cold/economy/high
- Low pressure indicator
- Variable sprayhead (4 position)

**S2263004** - T300si 9.5kw Electric Shower Finish White/Chrome

**TRITON T80 Si**



- Push button start/stop
- Numbered temperature dial for easy temperature selection
- Power selector for cold/economy/high
- Low pressure indicator
- Variable sprayhead (3 position)

**S2264001** - T80Si 8.5kw Electric Shower Finish White/Chrome

**TRITON MILLENNIUM**



- Thermostatic temperature control
- Push button start/stop with phased shutdown
- Numbered temperature dial for easy temperature selection
- Adjustable maximum temperature stop
- Push button power selector cold/low/medium/high
- Variable sprayhead (2 position)

**S2263001** - Millenium 8.5kw Electric Shower Finish White/Chrome

**TRITON T70 Si**



- Single control for start/stop and power setting cold/economy/high
- Numbered temperature dial for easy temperature selection
- Single mode sprayhead

**S2264502** - T70Si 7kw Electric Shower Finish White/Chrome

**S2264501** - T70Si 8kw Electric Shower Finish White/Chrome

**TRITON T100 i**



- Push button start/stop with phased shutdown
- Temperature control with LED display
- Push button power selector cold/economy/high
- Auto reset indicator
- Low pressure indicator
- Clean spray head indicator
- Safety check indicator
- Variable sprayhead (4 position)

**S2263005** - T100i 8.5kw Electric Shower Finish White/chrome

**TRITON T50 i**



- Single control for start/stop and temperature adjustment
- Numbered dial for easy temperature selection
- Single mode sprayhead

**S2263504** - T50i 7kw Electric Shower Finish White/Chrome

For Shower Trays See Page 195

**Triton Electric Showers**



**TRITON T90 Si PUMPED**

- For installation where mains pressure is too low or non existent
- Tank fed with integral Pump
- Push Button start/stop
- Temperature control with numbered dial for ease of selection
- Power Selector for cold/economy/medium/full
- variable spray head (3 Positions)

**S2263501 - T90Si 8.5kw Pumped Electric Shower  
Finish White/Chrome**

**T450i Booster Bump**



**S2263006 - T450i Electric Shower Booster Pump**

**T40i Booster Bump**



**S2263003 - T40i Booster Pump for Bath/Shower Mixers**

**T30i HANDWASH UNIT**



**S2266001 - T30i 7kw Handwash Unit**

**Electric Care Showers**



- Thermostatic temperature control
- Adjustable maximum temperature stop
- Extended hose and riser bar
- Easy grip adjustable spray head
- Easy grip control lever

**S2263002 - Millenium Care 8.5kw Electric Shower. Finish White/Chrome**



- Extended hose and riser bar
  - Easy grip adjustable spray head
  - Easy grip control lever
- S2263502 - T100E Care 8kw Electric Shower. Finish White/Chrome**

**S2263503 - Extended Control Lever**



**S8050184 - Mira Advance Standard 8.7kw Electric Shower Finish White/Chrome**

**S8050185 - Special Needs, Hose, Handset and Slide Bar For Above.**



**S8050183 - Mira Advance Flex standard 8.7kw Electric Shower Complete with Special Needs Kit Finish White/Chrome**

For Phlexicare Shower Trays See Page 79-90



# LESS ABLE SHOWERING – – A COMPLETE SOLUTION



Complying with the TMV3 scheme, the SIRRUS less able shower and accessories combine to make it easier for those with limited mobility to take a shower. The ergonomically designed lever provides easy purchase to allow adjustment of water temperature within an acceptable preset thermostatic range, whilst the hand set has been developed for ease of operation and grip. For added security and piece of mind there is an L-shape grab rail to aid stability.



BSM3000-CP



## DUETTE Thermostatic Control Bath and Shower Mixer BSM3000-CP

- Brass bodied construction
- Full thermostatic control ensures safe temperature delivery to bath & shower prevents scalding
- Unique single control unit for bath and shower modes



TSI503 SCP-L

## Single Lever Control Valve TSI503 SCP-L/ECP-L/CCP-L

- 15mm compression fitting
- Preset at 43°C maximum
- Suitable for use with any plumbing system



APPROVED



TSI503 ECP-L



TSI503 CCP-L

KIT EGB



## Less Able Adjustable Spray Hand Set, Hose & Riser Rail Kit EGB

- Ergonomically designed hand set for ease of operation and grip
- Lever operated handset holder enabling easy operation for users with reduced dexterity
- Extra wide slide rails which double as grab rails



KIT GB

## L-shape Grab Rail Kit GB

- Concealed fixing points
- Extra wide rail
- Ergonomically designed to offer ultimate support and safety

## Extended 900mm Slide Rail EEVK-CP

- 900mm extended slide rail
- Easy to use hand set holder with simple push button operation
- Stylish Eco-Vari spray hand set with dual mode function

# SIRRUS

SHOWERS • TAPS • CONTROLS



**Stratos - Dual Control Thermostatic Shower Mixer Valve**

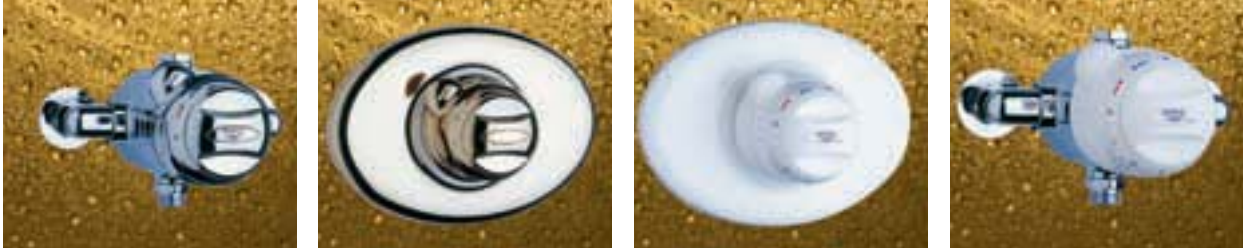

- Compatible with any plumbing system
- Instant thermostatic shut off in the event of hot or cold water failure
- Factory set at 43° ensures safe maximum operating temperature
- Separate flow and temperature control
- Adjustable inlet elbows for ease of installation (exposed models)
- Brass body ensure longevity in hard water areas

<b>S2247701</b> - Exposed Valve Only	<b>Chrome Body, White Controls</b>
<b>S2250002</b> - Exposed Valve Only	<b>Chrome Body, Chrome Controls</b>
<b>S2247702</b> - Exposed Valve Only	<b>Gold Body, Gold Controls</b>
<b>S2247801</b> - Concealed Valve Only	<b>Chrome Body, White Controls</b>
<b>S2247803</b> - Concealed Valve Only	<b>All White Finish</b>
<b>S2250003</b> - Concealed Valve Only	<b>Chrome Body, Chrome Controls</b>
<b>S2247802</b> - Concealed Valve Only	<b>Gold Body, Gold Controls</b>

**Calvus - Single Control Thermostatic Shower Mixer Valve**



- Compatible with any plumbing system
- Instant thermostatic shut off in the event of hot or cold water failure
- Factory set at 43° ensures safe maximum operating temperature
- Single dial control for on/off and temperature
- Adjustable inlet elbows for ease of installation (exposed models)
- Brass body ensures longevity in hard water areas.

<b>S2247901</b> - Exposed Valve Only	<b>Chrome Body, White Controls</b>
<b>S2247903</b> - Exposed Valve Only	<b>Chrome Body, Chrome Controls</b>
<b>S2248001</b> - Concealed Valve Only	<b>Chrome Body, White Controls</b>
<b>S2248004</b> - Concealed Valve Only	<b>Chrome Body, Chrome Controls</b>
<b>S2248003</b> - Concealed Valve Only	<b>All White Finish</b>

**Cumulus - Single Lever Control Manual Mix Shower Valve**



- Compatible with any plumbing system
- High performance blender shower
- Single lever operated both flow and temperature
- Ceramic disc cartridge resists limescale build up
- Adjustable inlet elbows for ease of installation (exposed model)

<b>S2250004</b> - Exposed Valve Only	<b>All Chrome</b>
<b>S2250005</b> - Concealed Valve Only	<b>All Chrome</b>

All concealed valves include wall outlet elbow

For Shower Kits see Page 208

## Alto - Dual Control Manual Mix Shower Valve



- Compatible with any plumbing system
- Separate flow and temperature control
- Brass body ensures longevity in hard water areas
- Adjustable inlet elbows for ease of installation (exposed model)

S2248610 - Exposed Valve Only All Chrome  
 S2248611 - Concealed Valve Only All Chrome  
 S2248612 - Concealed Valve Only All White

All concealed valves include wall outlet elbow

## Shower Kits



S2250006 - Shower Kit all Chrome with Multifunction Head Slide Rail, Hose and Soap Dish

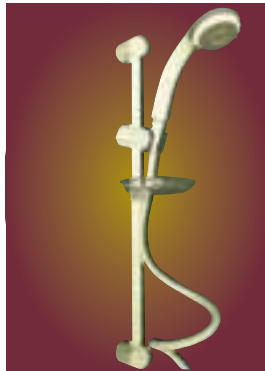

S2251703 - Shower Kit all White with Multifunction Head Slide Rail, Hose and Soap Dish



S2251702 - Shower Kit all Gold with Multifunction Head Slide Rail, Hose and Soap Dish



S2251801 - Vari-Spray Fixed Rose with Arm Chrome  
 S2251802 - Vari-spray Fixed Rose with Arm Gold  
 S2251803 - Vari-Spray Fixed Rose with Arm White



S2249801 - Fixed Arm Only 180mm Protection Chrome



S2249803 - Fixed Arm Only 90mm Protection Chrome



S2250101 - Speakman Fixed Shower Rose 4 Prong Chrome

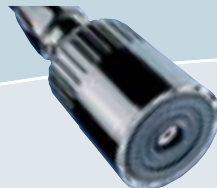

S2250103 - Swivel Shower Head Chrome (15mm compression)



S2250105 - Adjustable Spray Body Jets Chrome



S2250106 - 3 Way Dial Diverter Chrome

S2250102 - Speakman Fixed Shower Rose 6 Prong Chrome

S2250104 - Swivel Shower Head Chrome (15mm F.I.)

Shower kits shown are compatible with 'Stratos', 'Calvus', 'Cumulus' and 'Alto' range of valves.

## Storm Shower Pumps



P6821495 - Twin impellor Shower Pump 1.5 Bar  
 S2250011 - Twin impellor Shower Pump 3.0 Bar

**Deluxe - Single Control Thermostatic Valve With Kit**



- Compatible with any plumbing system
- Instant thermostatic cut off in the event of hot or cold water failure
- Factory set at 43° ensures safe maximum operating temperature
- Single lever control for on/off and temperature
- Brass body/adjustable inlets
- 4 Inch swivel rose provided with fixed kits.

**S2247611** - Exposed Complete with Rigid Kit Chrome

**S2247601** - Exposed Complete with Rigid Kit Gold

**S2248601** - Concealed with concealed Arm Kit Chrome

**S2248602** - Concealed with Concealed Arm Kit Gold

**Duelle - Dual Control Thermostatic Valve With Kit**



- Compatible with any plumbing system
- Instant thermostatic cut off in the event of hot or cold water failure
- Factory set at 43° ensures safe maximum operating temperature
- Separate flow and temperature control
- Brass Body (Adjustable Inlets)
- 5 Inch swivel rose provided with fixed kit

**S2247612** - Exposed Complete with Rigid Kit Chrome

**S2247613** - Exposed Complete with Rigid Kit Gold

**S2247614** - Concealed with Concealed Arm Kit Chrome

**S2247615** - Concealed with Concealed Arm Kit Gold



**S2247616** - 8" Chrome Apron Shower Head  
**S2247617** - 8" Gold Apron Shower Head



**Group Mixing Valves and Heads**



**S2250301** - 15mm Exposed Thermostatic Group Mixing Valve



**S2250007** - 22mm Exposed Thermostatic Group Mixing Valve



**S2250601** - Vandal Resistant Manual Economy Timed Flow Valve Exposed Chrome



**S2250602** - Vandal Resistant Manual Economy Timed Flow Valve Concealed Chrome



**S2250801** - Adjustable Vandal Resistant Shower Head Chrome (Bottom or Rear Entry)

**Shower Kits**



**S2250001** - Exposed Rigid Kit with Riser, Rose and Arm (144-224mm Projection). Chrome



**S2249302** - Exposed Rigid Kit with Riser, Rose and Arm (85mm Projection) Chrome



**S2249201** - Concealed Swivel Shower Head and Arm (110-190mm Projection) 1/2" BSP inlet. Chrome.



**S2249301** - Concealed Swivel Shower Head and Arm (90mm Projection) 1/2" BSP inlet. Chrome.

**Straight Tubular Shower Curtain Rail Exposed Fixing Flanges**



- S2238001 - 915mm Long x 25mm Dia Rail Chrome
- S2238002 - 1220mm Long x 25mm Dia Rail Chrome
- S2238003 - 1675mm Long x 25mm Dia Rail Chrome
- S2238005 - Exposed Flanges for above Chrome-Pair

**Self Assembly Tubular Shower Curtain Rail System**

(To Create 'L' and 'U' Shaped Rails)



- S2238511 - 710mm Long x 25mm Dia Rail Chrome
- S2238512 - 865mm Long x 25mm Dia Rail Chrome
- S2238513 - 1170mm Long x 25mm Dia Rail Chrome
- S2238514 - 1830mm Long x 25mm Dia Rail Chrome
- S2238515 - 2440mm Long x 25mm Dia Rail Chrome

- S2238501 - Concealed Fixing Wall Flange Chrome-Pair
- S2238531 - Spring Curtain Hooks Chrome (12 Per Pack)

• All shower rails can be cut to size



- S2238502 - Angle Bend Chrome
- S2238521 - 915mm Ceiling Support Stay Chrome
- S2238522 - 455mm Ceiling Support Stay Chrome

• Ceiling Supports are adjustable length.

**Shower Curtains with Lead Weighted Hems 100% Shower Proof**



- S2238540 - 1830mm x 2135mm Drop White
- S2238541 - 1830mm x 1830mm Drop White
- S2238542 - 2135mm x 2135mm Drop White
- S2238544 - 2135mm x 2135mm Drop Extra Heavy Duty. White (22grm)
- S2238543 - 1800mm x 1400mm Drop White

Curtains and Tracks



**Flexible White Coated Aluminium Shower Track**



- S2239601 - 2900mm Long Track with Fittings
- S2239611 - 2400mm Long Track with Fittings
- S2239615 - Pack of 12 Additional Hooks (for use with 2135mm curtains)
- S2239610 - 610mm Long Additional Ceiling Support
- S2239609 - 1200mm Long Additional Ceiling Support

Track supplied complete with 500mm adjustable ceiling support, easy glide rollers and 12 hooks.

**Rigid Shower Track with Fittings Anodised Aluminium**



**STRAIGHT RAILS**

- S2239001 - 760mm Silver
- S2239002 - 760mm Gold
- S2239011 - 915mm Silver
- S2239012 - 915mm Gold
- S2239021 - 1830mm Silver
- S2239022 - 1830mm Gold
- S2239031 - 2440mm Silver
- S2239032 - 2440mm Gold

**ANGLE RAILS**

- S2239501 - 760 x 760mm Silver
- S2239502 - 760 x 760mm Gold
- S2239511 - 915 x 915mm Silver
- S2239512 - 915 x 915mm Gold
- S2239521 - 1700 x 760mm Silver
- S2239522 - 1700 x 760mm Gold
- S2239531 - 1830 x 760mm Silver
- S2239532 - 1830 x 760mm Gold

Supplied complete with brackets, gliders, hooks. Angle rails include adjustable ceiling support.

**Shower Accessories**

**SHOWER HOSES. 13MM BSP FEMALE THREADS**

- S2255001 - 1200mm Chrome Finish Flexible Hose
- S2255011 - 1500mm Chrome Finish Flexible Hose
- S2255021 - 1800mm Chrome Finish Flexible Hose
- S2255002 - 1200mm Gold Finish Flexible Hose
- S2255012 - 1500mm Gold Finish Flexible Hose
- S2255022 - 1800mm Gold Finish Flexible Hose
- S2255003 - 1200mm White Finish Flexible Hose
- S2255013 - 1500mm White Finish Flexible Hose
- S2255023 - 1800mm White Finish Flexible Hose

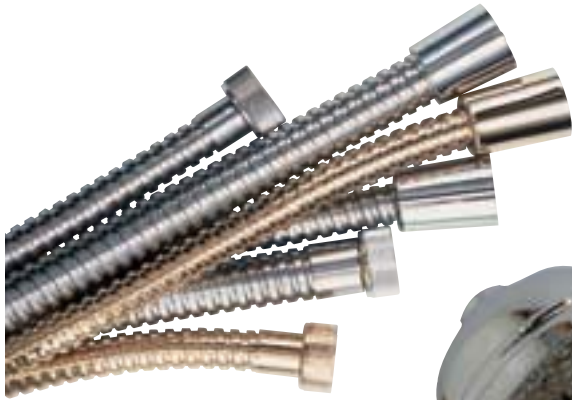

**S2250501**  
Apollo Chrome Adjustable Shower Rose 13mm BSP Female

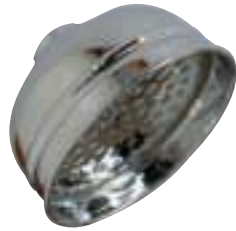

**S2251001**  
4" Dia. Chrome Apron Shower Rose. 13mm BSP Female



**S2252501**  
Lightweight Plastic Handshower 13mm BSP Male



**S2255101**  
Swanek Rigid Riser Kit Chrome Complete with Swivel Head 600mm Riser 3/4" Inlet



**S2255100**  
Sliding Rail Childrens Shower Kit, with Handshower, Sliding Rail and Hose. White with Red Fish and end Brackets.



**S2255105**  
Chrome Wall Bracket with Conical Pin



**S2255106**  
Chrome Swivel Connector. 1/2" Male x 1/2" Female

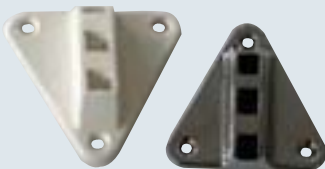

**S2255107**  
ABS Triangular Wall Bracket White  
**S2255108**  
ABS Triangular Wall Bracket Chrome



**S2255109**  
ABS Elbow 1/2" Female x 1/2" Male White  
**S2255110**  
ABS Elbow 1/2" Female x 1/2" Male Chrome



**S2255521**  
Chrome Adaptor 1/2" Male x 3/4" Female



**S2255112**  
Wall outlet elbow 1/2" Male x 1/2" Female Chrome

Showering

**Astoni Range**



**S6000049** - Liquid Soap Dispenser Chrome



**S6000053** - Toilet Roll Holder Chrome



**S6000057** - Towel Loop Chrome



**S6000050** - Soap Holder Chrome



**S6000054** - Robe Hook Chrome



**S6000058** - Glass Shelf Chrome



**S6000051** - Tumbler Holder Chrome



**S6000055** - Single Towel Rail Chrome



**S6000059** - Wall Mirror Chrome



**S6000052** - Toothbrush Holder Chrome



**S6000056** - Double Towel Rail Chrome

**Urban Spa Range**



**S6000070 - Soap Dish Chrome**



**S6000074 - Single Towel Rail Chrome**



**S6000071 - Tumbler Holder Chrome**



**S6000075 - Towel Ring Chrome**



**S6000072 - Toilet Roll Holder Chrome**



**S6000076 - Glass Shelf Chrome**



**S6000073 - Robe Hook Chrome**



**S6000077 - Wall Mirror Chrome**

**OTHER FINISHES AVAILABLE TO ORDER**



Gold



Chrome/Gold

Olympus Accessories

**New Wave Range**

Olympus Accessories



S6000040 - Single Towel Rail Chrome



S6000046 - Towel Ring Chrome



S6000045 - Frosted Liquid Soap Dispenser Chrome



S6000042 - Toilet Roll Holder Chrome



S6000041 - Double Towel Rail Chrome



S6000044 - Frosted Soap Dish Chrome



S6000043 - Frosted Tumbler Holder Chrome



S6000047 - Part Frosted Wall Mirror Chrome



S6000048 - Frosted Glass Shelf Chrome

OTHER FINISHES AVAILABLE TO ORDER



Gold



Satin Nickel



**Aqua Blue Range**

Olympus Accessories



**S6000030 - Single Towel Rail**  
Chrome/Blue



**S6000031 - Double Towel Rail**  
Chrome/Blue



**S6000032 - Towel Ring**  
Chrome/Blue



**S6000033 - Tumbler Holder**  
Chrome/Blue



**S6000034 - Soap Dish**  
Chrome/Blue



**S6000035 - Wall Mirror**  
Chrome/Blue



**S6000036 - Shelf with Rail** Chrome/Blue



**S6000037 - Toilet Roll Holder**  
Chrome/Blue



**S6000038 - Toothbrush Holder**  
Chrome/Blue

OTHER FINISHES AVAILABLE TO ORDER



Chrome & Green



All Chrome



Chrome and Gold

**Sienna Range**

The Sienna Range of accessories is stocked in two options. Chrome fitting with chrome backplate (CP/CP) or chrome fitting with gold backplate (CP/GP).



S7000010 - Towel Ring CP/CP  
S7000011 - Towel Ring CP/GP



S7000060 - Double Towel Rail CP/CP  
S7000061 - Double Towel Rail CP/GP



S7000020 - Soap Dish CP/CP  
S7000021 - Soap Dish CP/GP



S7000070 - Glass Shelf and Brackets CP/CP  
S7000071 - Glass Shelf and Brackets CP/GP



S7000030 - Toilet Roll Holder CP/CP  
S7000031 - Toilet Roll Holder CP/GP



S7000080 - Wall Mirror CP/CP  
S7000081 - Wall Mirror CP/GP



S7000040 - Toothbrush and Tumbler Holder CP/CP  
S7000041 - Toothbrush and Tumbler Holder CP/GP



S7000050 - Single Towel Rail CP/CP  
S7000051 - Single Towel Rail CP/GP



S7000084 - Double Robe Hook CP/CP  
S7000085 - Double Robe Hook CP/GP

**Economy Range**



**S2810001** - 455mmx17mm Dia C.P. Single Towel Rail  
**S2810011** - 610mmx17mm Dia C.P. Single Towel Rail  
**S2810021** - 760mmx17mm Dia C.P. Single Towel Rail

**S2810501** - 610mmx17mm Dia C.P. Double Towel Rail  
**S2810511** - 760mmx17mm Dia C.P. Double Towel Rail



**S2811021** - 760mm x 19mm Dia C.P. Single Towel Rail with Loose Brackets  
**S2811521** - 915mm x 25mm Dia C.P. Single Towel Rail with Loose Brackets

**S2812001** - 420mm Proj. CP Double Arm Swing Rail

(Can be cut to length if required)



**S2812011** - 420mm Proj. CP Triple Arm Swing Rail

**S2813001** - C.P. Toilet Roll Holder Spring Loaded Roller

**S2813005** - Spare Rollers to Suit

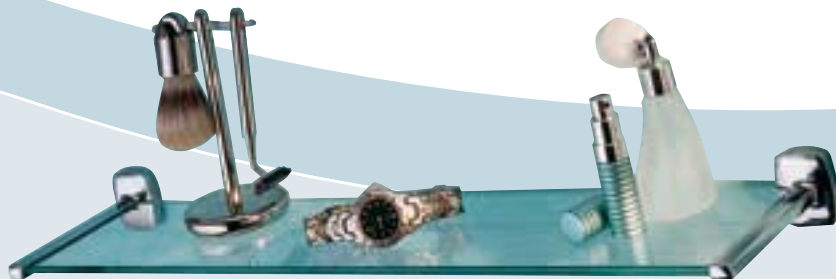

**S2814501** - Glass Shelf Complete with C.P. Brackets Shelf Width 125mm

**S2816501** - Extending Shaving Mirror 180mm Dia. C.P. (Adjustable 210-500mm)

**Economy Range (Concealed Fixings)**

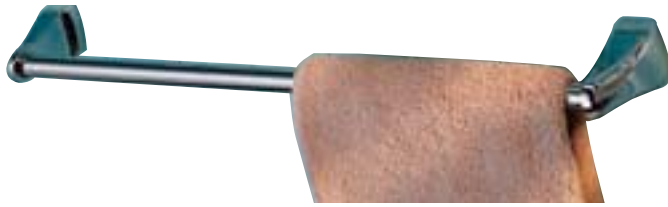

S2820001 - 610x25mm Dia C.P. Towel Rail

S2820011 - 760x25mm Dia C.P. Towel Rail

S2820021 - 915x25mm Dia C.P. Towel Rail



S2820501 - 420mm Proj. C.P. Double Arm Swing Rail



S2822001 - C.P. Single Bar Toilet Roll Holder



S2821001 - C.P. Towel Ring



S2821501 - C.P. Toilet Roll Holder



S2822501 - C.P. Toilet Pack Holder



S2823001 - C.P. Soap Dish



S2823501 - C.P. Toothbrush and Tumbler Holder



S2824001 - C.P. Toothbrush Holder



S2825001 - C.P. Hat and Coat Hook



S2825501 - C.P. Single Robe Hook



S2826001 - C.P. Double Robe Hook



S2827001 - C.P. Ash Tray



S2827501 - C.P. Magnetic Soap Holder

S2826501 - C.P. Four Arm Stocking Rail





Ceramic range



T9001028 - Double Soap Dish White



T9008028 - Ceramic Shelf White 480mm



T9060024 - Ceramic Beaker, White



T9002028 - Single Soap Dish White



T9011028 - Ceramic Shower Shelf White



T9054024 - Toilet Roll Holder White



T9020028 - Single Soap Dish, Semi Recessed White



T9003028 - Toilet Roll Holder White



T9050024 - Single Soap Dish White



T9055024 - Double Soap Dish White



T9021028 - Toilet roll Holder, Semi Recessed White



T9004028 - Towel Loop White



T9051024 - Tooth Brush Holder White



T9057024 - Towel Rail White



T9052024 - Robe Hooks White (Pair)



T9007028 - Robe Hook White



T9053024 - Towel Loop White



T9059024 - Toilet Brush Holder and Brush White



T9058024 - Ceramic Mirror White



For more information go to [www.barbourproductsearch.info](http://www.barbourproductsearch.info)

QUALITY BATHROOM ACCESSORIES

PROTEUS Doc 'M' pack

# PROTEUS



FROM  
W A T E R B U R Y



## Bathroom Cabinets



**S2930001** - Model 300B White Single Door Mirrored Cabinet 300 x 422mm



**S2930501** - Model 600B White Double Door Mirrored Cabinet 600 x 422mm



**S6000060** - 'Luca' 100 Rectangular Cabinet Stainless Steel



**S6000061** - 'Luca' 101 Square Cabinet Stainless Steel



**S6000063** - 'Luca' 103 Oval Cabinet Stainless Steel



**S6000062** - 'Luca' 102 Round Cabinet Stainless Steel



**S6000064** - Medicine Cabinet Lockable - White 300 x 280 x 150mm Deep

**Olympus Dispensers**



**S2940001 - Model NC2 Automatic Hand Drier 2.1kw 240V. Acrylic Capped Fire Resistant ABS Case - White Finish**



**S2943001 - C.P. Tip Up Liquid Soap Dispenser 0.38 Ltr Capacity**



**S2941001 - Model NC5 Automatic Hand and Face Drier 2.3kw 240V. Heavy Duty Cast Aluminium Casing. White Epoxy Polyester Finish**

**AUTOMATIC CLOAKROOM DISPENSER**

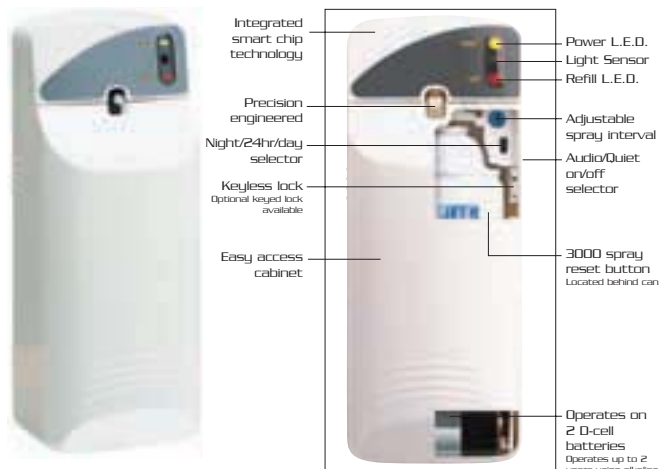

A unique cloakroom dispenser designed to spray air freshener or insecticide at regular timed intervals. A battery operated motor works in conjunction with an electronic timing mechanism. A variable dial is used to pre-set the time interval of sprays from 5-25 minutes. An exterior On/Off selector switch allows the system to run in a continuous "on" mode, but the unit may be turned off if the spray protection is not required for an extended period of time. The unit also incorporates an interior 3 position mode switch:

**DAY:** A light sensor activates the motor to turn off when lights are turned off and reverts to "on" when lights are turned on again.

**ON:** Unit runs 24 hours a Day.

**NIGHT:** A sensor activates the motor to turn the unit on when lights are turned off, and reverts to "off" when light is sensed again (ideal for after hour insecticides)

Spray canisters will spray 3000 times before replacement is necessary.

Casing made from ABS plastic material

- S2948001 - Broadgate Dispenser Unit**
- S2948501 - Spray Canister Designer Fragrance (Male)**
- S2948502 - Spray Canister Designer Fragrance (Female)**
- S2948503 - Spray Canister Country Garden Fragrance**
- S2948505 - Spray Canister Air Sanitizer (12 Per Pack)**



**S2946001 - C.P. Dreadnought Vandal Resistant Toilet Roll Holder**

**Olympus Dispensers**

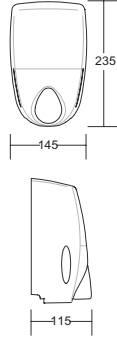

**S2942002 - Chrome Soap Dispenser for Cartridge. Locking Cover**

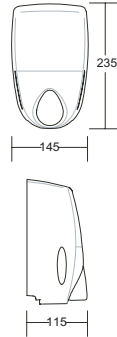

**S2942001 - White ABS Soap Dispenser for Cartridge. Locking Cover**

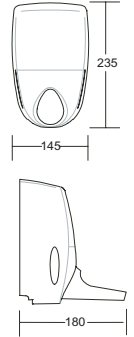

**P6834201 - White ABS Soap Dispenser for Cartridge. Locking Cover and Extended Lever Operation.**

**S2942501 - Pack of 1 Ltr Cartridges (6 per Pack)**

**S2942501 - Pack of 1 Ltr Cartridges (6 per Pack)**

**S2942501 - Pack of 1 Ltr Cartridges (6 per Pack)**

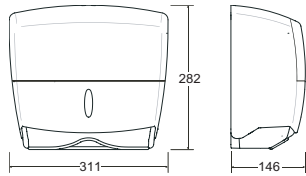

**P6834301 - White ABS Hand Towel Dispenser. Locking Cover.**  
**P6834311 - Interleaved Paper Towels (Box)**

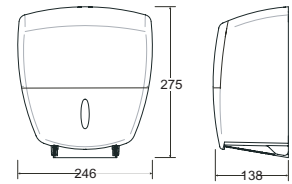

**S2946501 - White ABS Jumbo Roll Dispenser 20cm**  
**S2946551 - Rolls of Toilet Tissue (6 Per Pack)**



Pastel colours available to order in all dispensers shown above.

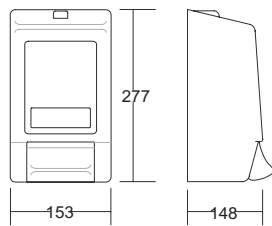

**S2943501 - White ABS Soap Gel Dispenser 2 Ltr Capacity**

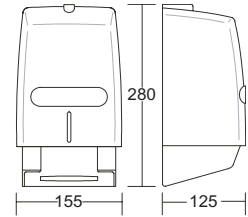

**S2944001 - White ABS Toilet Tissue Dispenser. Locking Cover**  
**S2944011 - Box Toilet Tissue (36 pks per box)**

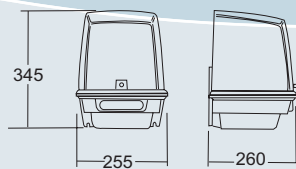

**S2947001 - White ABS Centre Pull Paper Towel Dispenser. Locking Cover**  
**S2947011 - Rolls of Paper Towel**

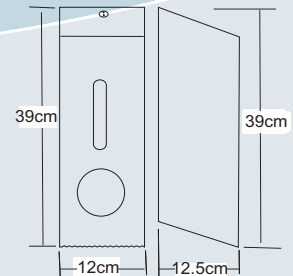

**S2944501 - White Coated Metal, Triple Roll Toilet Paper Dispenser. Locking Cover**

Sanitaryware

**Olympus Dispensers**

Washroom Accessories

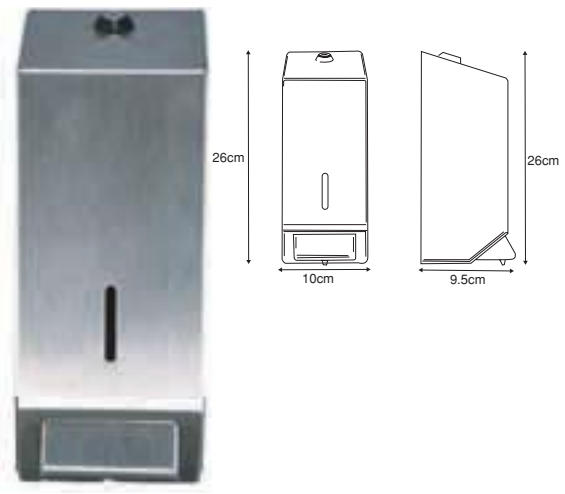

**S2942010 - Brushed S/Steel 1 Ltr Refillable Soap Dispenser. Locking Cover**

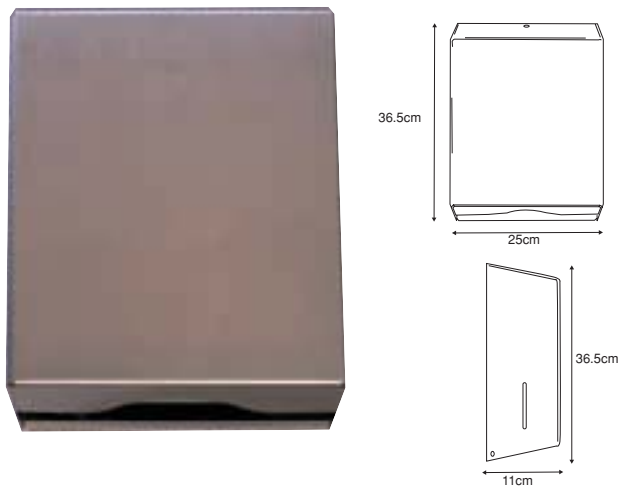

**S2942011 - Brushed S/Steel Hand Towel Dispenser. Locking Cover**  
**S2942012 - Interleaved Paper Towels**

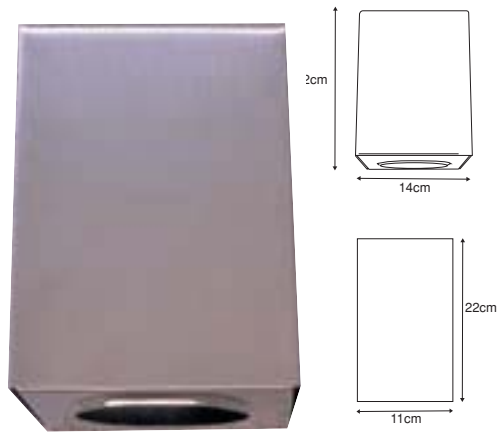

**S2942013 - Brushed S/Steel Toilet Tissue Dispenser. Locking Cover**

**S2944011 - Box of Toilet Tissue (36 pks per box)**



**S2942014 - Brushed S/Steel Centre Feed paper Towel Dispenser. Locking Cover**

**S2942015 - Rolls of Paper Towel**



**S2942016 - Brushed S/Steel Mini Jumbo Toilet Tissue Dispenser 26cm. Locking Cover**

**S2942017 - Rolls of Toilet Tissue**

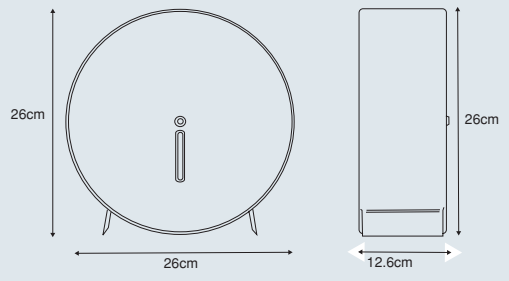

ALL DISPENSERS ON THIS PAGE ARE AVAILABLE IN CHROME FINISH IF REQUIRED.



For more information go to [www.barbourproductsearch.info](http://www.barbourproductsearch.info)

pagette®



## durastone

SHOWER TRAYS

Durastone shower trays from Pagette are manufactured to exacting standards using an advanced formulation of polyester resin and stone covered with an acrylic capped ABS layer providing lasting durability.

With over 80% ground calcium carbonate powder and 2mm of acrylic capped ABS, Durastone trays are designed to withstand the rigours of a busy home.

- High Impact Resistance
- High Gloss Finish
- Slip Resistant
- Scratch Resistant

Super hard advanced formulation of resin bonded stone.

Smooth 'Anti-Slip' acrylic with distinctive tread pattern.

2mm layer of acrylic capped

Tough  
never looked  
so good...

**Polypipe Bathroom and Kitchen Products Limited**  
Warmsworth Halt Industrial Estate, Warmsworth,  
Doncaster DN4 9LS



**POLYPIPE**  
BATHROOM & KITCHEN  
PRODUCTS LTD

Waste Fittings

BATHS

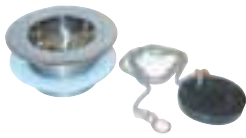

S2360001 - Bath Waste, Plug and Chain Un-slotted 38mm. Chrome Finish



S2360501 - Bath Waste and Combined Overflow with Plug and chain. 38mm Chrome Finish

S2360502 - Bath Waste and Combined Overflow with Plug and Chain. 38mm Gold Finish



S2360503 - Bath Waste and Combined Overflow with Plug and Chain. 38mm All Chrome Finish



S2362001 - Bath Pop-up Waste and Combined Overflow 38mm Chrome Finish

S2362002 - Bath Pop-up Waste and Combined Overflow 38mm Gold finish

BASINS



S2365001 - Basin Waste, Plug and Chain, Slotted. 32mm Chrome Finish  
S2365002 - Basin Waste, Plug and Chain, Slotted. 32mm Gold Finish



S2365003 - Basin Waste, Plug and Chain, Slotted. 32mm All Chrome Finish



S2365501 - Basin Waste with Captive Plug, Slotted. 32mm All Chrome Finish



S2366501 - Basin Flush Grated Waste, Unslotted. 32mm All Chrome Finish



P6848501 - Presflo Basin Waste, Slotted. 32mm All Chrome Finish

SINK TOPS



S2361001 - Sink Waste and Combined Overflow with Plug and Chain. 38mm Chrome Finish  
S2361011 - Sink Waste and Combined Overflow with Plug and Chain. 32mm Chrome Finish



S3015001 - Crumb Strainer Waste 38mm Chrome Finish

URINALS



S2199541 - Hinged Domical Grating 64mm All Chrome Finish  
S2199542 - Hinged Domical Grating 38mm All Chrome Finish  
S2199543 - Hinged Domical Grating 32mm All Chrome Finish



S2366502 - White Plastic Domed Urinal Waste 32mm  
S2366503 - White Plastic Domed Urinal Waste 38mm



S2366501 - Flush Grated Urinal Waste 32mm All Chrome Finish  
S2194602 - Flush Grated Urinal Waste 38mm All Chrome Finish

CERAMIC SINKS AND SHOWER TRAYS



S2366001 - Flush Grated Waste Un-slotted. 38mm All Chrome Finish  
S2366002 - Flush Grated Waste Un-slotted. 38mm All Gold Finish



S2367001 - Sink Waste, Plug and Chain Slotted 38mm . Chrome Finish  
S2367501 - Sink Waste, Plug and Chain Un-slotted 38mm. Chrome Finish



S2370501 - 38mm Combined Shower Waste and Trap. White Plastic Body, Chrome Flange

HOLE STOPPERS



S2362501 - Bath Overflow Hole Stopper. Chrome  
S2362502 - Bath Overflow Hole Stopper. White Plastic

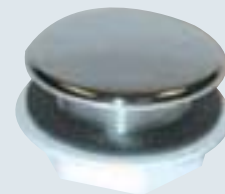

S2363001 - Taphole stopper. Chrome  
S2363002 - Taphole stopper. White Plastic

Traps



**S2370511** - Trapped Shower Gully 2 1/2" outlet 75mm Seal. (130mm Overall Depth) White Plastic



**S2372111** - Re-sealing Bottle 'P' trap, Fixed inlet-38mm. White Plastic



**S2373101** - Shallow Seal Bath Trap 19mm Seal, 32mm Fixed inlet. White Plastic  
**S2373111** - Shallow Seal Bath Trap 19mm Seal, 38mm Fixed inlet. White Plastic



**S2380501** - Chrome Extension to Wall with Wall Plate 32mm (To Suit S2380001)  
**S2380511** - Chrome Extension to Wall with Wall Plate 38mm (To suit S2380011)



**S2371001** - Bottle 'P' Trap Fixed inlet. 75mm Seal. inlet-32mm White Plastic



**S2372601** - Tubular 'P' Trap 75mm Seal Adjustable inlet-32mm. White Plastic  
**S2372611** - Tubular 'P' Trap 75mm Seal Adjustable inlet-38mm. White Plastic



**S2373501** - Bath 'P' Trap 75mm Seal, 38mm Fixed inlet. White Plastic



**S2374601** - Running Trap, 75mm Seal, inlet 32mm White Plastic

**S2371011** - Bottle 'P' Trap Fixed inlet. 75mm Seal. inlet-38mm White Plastic



**S2371101** - Bottle 'P' Trap Fixed inlet. 38mm Seal. inlet-32mm White Plastic  
**S2371111** - Bottle 'P' Trap Fixed inlet. 38mm Seal. inlet-38mm White Plastic



**S2372801** - Tubular 'P' Trap 75mm Seal Fixed inlet-32mm White Plastic  
**S2372802** - Tubular 'P' Trap 75mm Seal Fixed inlet-38mm White Plastic



**S2374001** - Anti Syphon Bottle 'P' Trap, 75mm Seal, inlet-32mm. White Plastic  
**S2374011** - Anti Syphon Bottle 'P' Trap, 75mm Seal, inlet-38mm. White Plastic



**S2375615** - 38mm 1 1/2 Bowl Plumbing Kit for Sink Tops. Comprising inlet Connections, 75mm Seal Tubular Swivel 'P' Trap and Provision for Connection to Dishwasher or Washing Machine.



**S2372901** - Tubular 'S' Trap 75mm Seal, Fixed inlet-32mm White Plastic  
**S2372902** - Tubular 'S' Trap 75mm Seal, Fixed inlet-38mm White Plastic



**S2374501** - Anti Syphon Bath 'P' Trap, 50mm Seal, inlet-38mm White Plastic



**S2375601** - 38mm Washing Machine Trap White Plastic

**S2371601** - Bottle 'P' Trap Adjustable inlet 75mm Seal. Inlet - 32mm White Plastic  
**S2371611** - Bottle 'P' Trap Adjustable inlet 75mm Seal. Inlet - 38mm White Plastic



**S2372001** - Bottle 'P' Trap Adjustable inlet 75mm Seal. inlet-32mm. Chrome on Plastic



**S2373001** - Tubular All in One Trap 75mm Seal Adjustable to Provide 'S' 'P' or 'Q' Type Connection. Adjustable inlet-32mm White Plastic  
**S2373011** - Tubular All in One Trap 75mm Seal Adjustable to Provide 'S' 'P' or 'Q' Type Connection. Adjustable inlet-38mm White Plastic  
**S2373021** - Tubular All in One Trap 75mm Seal Adjustable to Provide 'S' 'P' or 'Q' Type Connection. Adjustable inlet-50mm White Plastic



**S2380001** - Chrome on Metal Bottle 'P' Trap, Adjustable inlet, 75mm Seal, inlet-32mm.  
**S2380011** - Chrome on Metal Bottle 'P' Trap, Adjustable inlet, 75mm Seal, inlet-38mm.



**S2375511** - 38mm Tee Piece with Hose Connection for Washing Machine



**S2375511** - 38mm Tee Piece with Hose Connection for Washing Machine

**Water Fittings**

**CRUTCH HEAD BIB TAP**



Brass, dipped finish.  
**S2340001** - Size: 19mm BSP  
**S2340011** - Size: 13mm BSP

**LOCKSHIELD BIB TAP**



With loose key. Brass, dipped finish.  
**S2340501** - Size: 13mm BSP

**CRUTCH HEAD HOSE UNION BIB TAP**



Brass, dipped finish.  
**S2341501** - Size: 19mm BSP  
**S2341511** - Size: 13mm BSP

**LOCKSHIELD BIB TAP WITH HOSE UNION**



With loose key. Brass, dipped finish.  
**S2342001** - Size: 19mm BSP  
**S2342011** - Size: 13mm BSP

**CRUTCH HEAD STOPCOCK F x F**



Brass, dipped finish.  
**S2343001** - Size: 13mm BSP  
**S2343011** - Size: 19mm BSP  
**S2343021** - Size: 25mm BSP  
**S2343031** - Size: 32mm BSP  
**S2343041** - Size: 38mm BSP

**CRUTCH HEAD STOPCOCK MxF**



Brass, dipped finish.  
**S2343501** - Size: 13mm BSP  
**S2343511** - Size: 19mm BSP

**WASHING MACHINE VALVES**

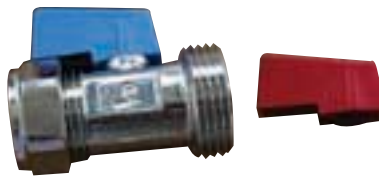

Male thread outlet. Finish: Matt Chrome.  
**S2344001** - Size: 15mm  
 Compression inlet.

**PLUG BIB COCK**



With locking lever. Brass, matt finish  
**S2344501** - Size: 13mm BSP  
**S2344511** - Size: 19mm BSP  
**S2344521** - Size: 25mm BSP

**SINGLE CHECK VALVE**



OZR Metal, Matt finish  
**S2348031** - Size: 15mm Compression  
**S2348041** - Size: 22mm Compression

**DOUBLE CHECK VALVE**



Designed to meet legislation for the prevention of back syphonage and contamination. Will operate vertically or horizontally.

OZR material, matt finish.  
**S2348001** - Size: 15mm Compression  
**S2348011** - Size: 22mm Compression  
**S2348021** - Size: 28mm Compression

**SAEFTAP**



A hose union bib tap with integral double check valve and test plug. Designed to meet new legislation for the prevention of back syphonage and contamination.  
**S2348501** - Size: 13mm BSP

**DRAW-OFF COCK**



Brass, matt finish.  
**S2345001** - Size: 13mm BSP  
**S2345011** - Size: 19mm BSP

**GATE VALVE F x F**



Brass, matt finish.  
**S2346001** - Size: 13mm BSP  
**S2346011** - Size: 19mm BSP  
**S2346021** - Size: 25mm BSP  
**S2346031** - Size: 32mm BSP

**LOCKSHIELD GATE VALVE F x F**



Brass, matt finish. With loose key.  
**S2346501** - Size: 13mm BSP  
**S2346511** - Size: 19mm BSP  
**S2346521** - Size: 25mm BSP  
**S2346531** - Size: 32mm BSP



**Water Fittings**

**SWING CHECK VALVE**



Brass, matt finish  
**S2347501** - Size: 13mm BSP  
**S2347511** - Size: 19mm BSP  
**S2347521** - Size: 25mm BSP

**ISOLATING VALVE**



Chrome matt finish.  
**S2349501** - Size: 15mm Compression  
**S2349511** - Size: 22mm Compression

**PORTSMOUTH FLOAT VALVE LIGHT PATTERN**

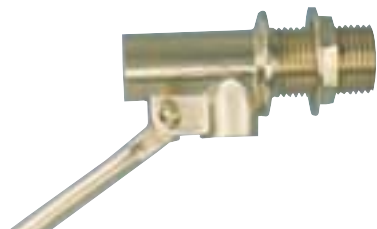

Brass, matt finish.  
**S2350001** - Size: 19mm BSP (HP)  
**S2350002** - Size: 19mm BSP (LP)

**BS.1212 PART 1 FLOAT VALVE**

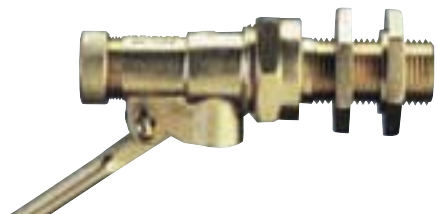

Brass, matt finish  
**S2350501** - Size: 13mm BSP (HP) Nylon Seat  
**S2350502** - Size: 13mm BSP (LP) Nylon Seat  
**S2350511** - Size: 19mm BSP (HP) Nylon Seat  
**S2350512** - Size: 19mm BSP (LP) Nylon Seat  
**S2350521** - Size: 25mm BSP (HP) Bronze Seat  
**S2350522** - Size: 25mm BSP (LP) Bronze Seat  
**S2350531** - Size: 32mm BSP (HP) Bronze Seat  
**S2350532** - Size: 32mm BSP (LP) Bronze Seat  
**S2350541** - Size: 38mm BSP (HP) Bronze Seat  
**S2350542** - Size: 38mm BSP (LP) Bronze Seat

**BS.1212 PART 2 FLOAT VALVE**



Top outlet and adjustable lever arm.  
 Length of tail: 32mm  
 Brass, matt finish  
**S2351001** - Size: 13mm BSP (HP) Nylon Seat  
**S2351002** - Size: 13mm BSP (LP) Nylon Seat

**EQUILLIBRIUM FLOAT VALVE**

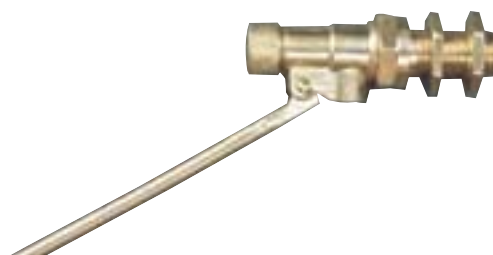

Design minimises effect of changing water pressure.  
 Suitable for pressure up to 14 bar (200 lbs psi). One seat bore diameter for each size, regardless of pressure.  
 Brass, matt finish  
**S2351501** - Size: 19mm BSP  
**S2351511** - Size: 25mm BSP  
**S2351521** - Size: 32mm BSP  
**S2351531** - Size: 38mm BSP

Note:  
 Some water authorities may require isolating valves and check valves fitted to this pattern ball valve.

**POLYPROPYLENE BALL FLOAT**



**S2353001** - Size: 115mm Diameter For 13mm BSP Ball Valves  
**S2353011** - Size: 125mm Diameter For 13mm BSP Ball Valves  
**S2353021** - Size: 150mm Diameter For 25mm BSP Ball Valves  
**S2353031** - Size: 200mm Diameter For 32mm BSP Ball Valves  
**S2353041** - Size: 225mm Diameter For 38mm BSP Ball Valves

**PLASTIC PET COCK**



For use with automatic cisterns.  
**S2354001** - 10mm

**EXTENSION PIECE**



Brass, CP finish  
**S2357001** - 50mm x 13mm  
**S2357011** - 75mm x 13mm  
**S2357021** - 50mm x 19mm  
**S2357031** - 75mm x 19mm

**BACK PLATE ELBOW**



Brass, CP finish  
**S2356501** - 15mm x 13mm  
**S2356511** - 22mm x 19mm

**BIB COCK STANDARD**



Brass, CP finish 150mm high  
**S2356001** - 13mm  
**S2356011** - 19mm



**Copper Tube and Fittings**

**COPPER TUBE**



The following tubes are normally available from stock:

- S2390001 - 15mm Table 'X'
- S2390002 - 22mm Table 'X'
- S2390003 - 28mm Table 'X'
- S2390004 - 35mm Table 'X'
- S2390005 - 42mm Table 'X'

**STAINLESS STEEL TUBE**

The following sizes are normally available to order:

- 15mm
- 22mm
- 28mm
- 35mm

**COPPER FITTINGS**

We stock a comprehensive range of fittings from the following manufacturers:

**PRESTEX COMPRESSION JOINTS**  
**YORKSHIRE CAPILLARY JOINTS**

Separate price brochures are obtainable on request for both these ranges. We list here the main items from each range which are in constant demand together with the sizes stocked. For ease of selection, the comparative patterns are grouped together, Prestex fittings being featured on the left and Yorkshire on the right.  
**Note:** Yorkshire fittings with the prefix 'YP' are manufactured from copper, and fittings without the prefix are gunmetal or brass.

**STRAIGHT COUPLING**



Copper x Copper  
**Prestex NO. 40**  
**Yorkshire NO. YP1**  
Sizes stocked:  
15mm to 42mm

**STRAIGHT REDUCING COUPLING**



Copper x Copper  
**Prestex NO. 39**  
Sizes stocked:  
22 x 15mm  
28 x 22mm  
35 x 28mm

**Yorkshire NO. YP1R**  
Sizes stocked:  
22 x 15mm  
28 x 22mm  
35 x 28mm  
42 x 28mm  
42 x 35mm

**STRAIGHT COUPLING**



Copper x Female Iron  
**Prestex NO. 41**  
**Yorkshire NO. YP2**  
Sizes stocked:  
15mm to 42mm

**STRAIGHT COUPLING**

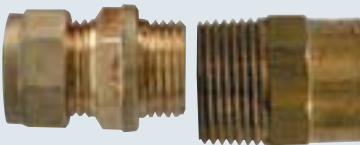

Copper x Male Iron  
**Prestex NO. 42**  
Sizes stocked:  
15mm to 42mm  
**Yorkshire NO. YP3**  
Sizes stocked:  
15mm to 28mm  
**Yorkshire NO. 3**  
Sizes stocked:  
35mm and 42mm

**STOP END**

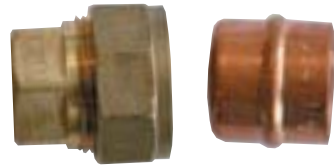

Copper x Blank End  
**Prestex NO. 37**  
**Yorkshire NO. YP61**  
Sizes stocked:  
15mm to 42mm

**TANK CONNECTOR**



Copper with flange and backnut  
**Prestex NO. 35**  
**Yorkshire NO. YP5**  
Sizes stocked:  
15mm to 42mm

**STRAIGHT TAP CONNECTOR**



Copper x Union nut  
**Prestex NO. 43**  
Sizes stocked:  
15mm to 28mm  
**Yorkshire NO. YP62**  
Sizes stocked:  
15mm, 22mm

**BENT TAP CONNECTOR**



Copper x Union nut  
**Prestex NO. 43B**  
Sizes stocked:  
15mm to 28mm  
**Yorkshire NO. YP63**  
Sizes stocked:  
15mm, 22mm

**Copper Tube and Fittings**

**ELBOW**



Copper x Copper  
**Prestex NO. 44**  
**Yorkshire NO. YP12**  
 Sizes stocked:  
 15mm to 42mm

**ELBOW**

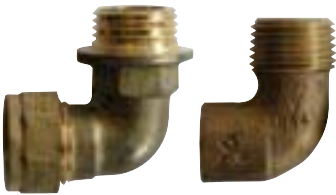

Copper x Male Iron  
**Prestex NO. 45**  
**Yorkshire NO. YP13**  
 Sizes stocked:  
 15mm to 42mm

**ELBOW**

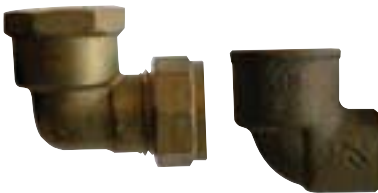

Copper x Female iron  
**Prestex NO. 46**  
**Yorkshire NO. YP14**  
 Sizes stocked:  
 15mm to 42mm

**OBTUSE ELBOW 45°**



Copper x Copper  
**Prestex NO. 440**  
**Yorkshire NO. YP21**  
 Sizes stocked:  
 15mm to 42mm

**SLOW BEND**



Copper x Copper  
**Prestex NO. 44S**  
 Sizes stocked:  
 15mm to 42mm

**STRAIGHT COUPLING WITH DRAIN TAP**



Copper x Copper  
**Prestex NO. 83**  
 Sizes stocked:  
 15mm to 28mm

**BACK PLATE ELBOW**



Copper x Female Iron  
**Prestex NO. 58X**  
 Sizes stocked:  
 15mm to 28mm

**EQUAL TEE**

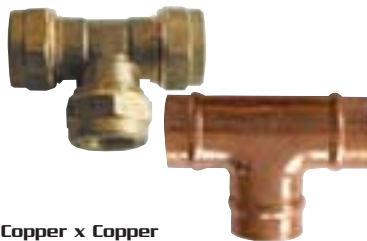

Copper x Copper  
**Prestex NO.50**  
**Yorkshire NO. YP24**  
 Sizes stocked:  
 15mm-42mm

**TEE BOTH ENDS REDUCED**



Copper x Copper  
**Prestex NO.50A**  
 Sizes stocked:  
 15 x 22mm  
 15 x 28mm  
 22 x 28mm  
 22 x 35mm  
 28 x 35mm  
 28 x 42mm

**Yorkshire NO.YP28**  
 Sizes stocked:  
 15 x 22mm  
 15 x 28mm  
 22 x 28mm  
 22 x 35mm  
 28 x 35mm  
 28 x 42mm  
 35 x 42mm

**TEE ONE END REDUCED**

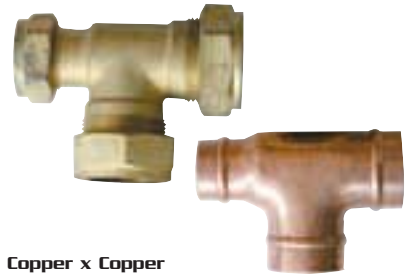

Copper x Copper  
**Prestex NO.50B**  
 Sizes stocked:  
 15 x 22mm  
 15 x 28mm  
 22 x 28mm  
 28 x 35mm  
 35 x 42mm

**Yorkshire NO.YP26**  
 Sizes stocked:  
 15 x 22mm  
 22 x 28mm  
 28 x 35mm  
 35 x 42mm

**TEE BRANCH REDUCED**

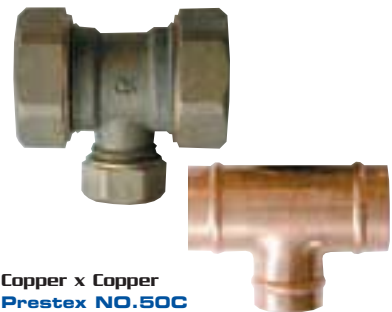

Copper x Copper  
**Prestex NO.50C**  
**Yorkshire NO.YP25**  
 Sizes stocked:  
 22 x 15mm  
 28 x 15mm  
 28 x 22mm  
 35 x 28mm  
 42 x 35mm

**TEE ONE END AND ONE BRANCH REDUCED**



Copper x Copper  
**Prestex NO.50D**  
**Yorkshire NO.YP27**  
 Sizes stocked:  
 22 x 15mm  
 28 x 15mm  
 28 x 22mm  
 35 x 28mm  
 42 x 35mm

**Copper Tube and Fittings**

**SWEEP TEE EQUAL**



Copper x Copper  
Yorkshire NO.YP37  
Sizes stocked:  
15mm - 42mm

**STOPCOCK**



Copper x Copper  
Prestex NO.59  
Sizes stocked:  
15mm - 42mm  
Yorkshire NO.YP501  
Sizes stocked:  
15mm - 28mm  
Yorkshire NO. YP501GM  
Sizes stocked:  
35mm and 42mm

**SNAP-ON PIPE CLIPS**



Made from white Polypropylene  
100 per pack  
S2600001 - Size: 15mm  
S2600011 - Size: 22mm  
S2600021 - Size: 28mm

**TEE WITH MALE IRON END**



Copper x Male Iron  
Prestex NO.51  
Sizes stocked:  
15mm - 35mm

**FULLWAY GATE VALVE**



Copper x Copper  
Prestex No.63  
Yorkshire No. YP610  
Sizes stocked:  
15mm - 42mm

**COPPER SADDLE CLIPS**



100 per pack  
S2601001 - Size: 15mm  
S2601011 - Size: 22mm  
S2601021 - Size: 28mm  
S2601031 - Size: 35mm  
S2601041 - Size: 42mm

**TEE WITH FEMALE IRON END**



Copper x Female Iron  
Prestex NO.52  
Sizes stocked:  
15mm - 35mm

**COPPER SPACING CLIPS**



100 per pack  
S2601501 - Size: 15mm  
S2601511 - Size: 22mm  
S2601521 - Size: 28mm  
S2601531 - Size: 35mm  
S2601541 - Size: 42mm

**TEE WITH FEMALE IRON BRANCH**



Copper x female Iron  
Prestex NO.54  
Sizes stocked:  
15mm - 35mm

**REDUCING SETS**



Copper x Copper  
Prestex NO.102/3/4  
Sizes stocked:  
15 x 8mm  
15 x 10mm  
15 x 12mm  
22 x 15mm  
28 x 15mm  
28 x 22mm  
35 x 28mm  
35 x 22mm  
42 x 35mm



**YORKSHIRE STEEL WOOL**  
S2602001 - 1lb Pack

**YORKSHIRE FLUX**  
S2602501 - 100g Carton  
S2602511 - 500g Carton

**SOLDER WIRE**  
S2603001 - 500g Reel

**Plastic Tube and Fittings - Push Fit**

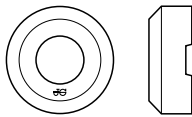

S9920050 - 22mm Collett Cover  
S9920051 - 15mm Collett Cover

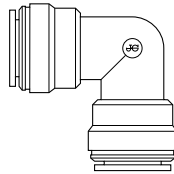

S9920059 - 22mm Elbow  
S9920060 - 15mm Elbow

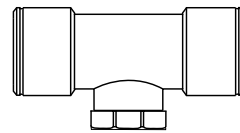

S9920068 - 22 x 22 x 15mm Reducing Tee  
S9920069 - 22 x 15 x 15mm Reducing Tee  
S9920070 - 15 x 15 x 22mm Reducing Tee

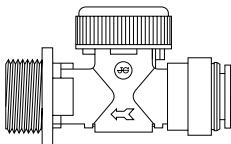

S9920052 - 15mm x 3/4" Washing Machine Tap

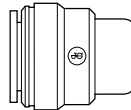

S9920061 - 15mm Stop End  
S9920062 - 22mm Stop End



S9920071 - 15mm Service Valve

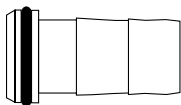

S9920053 - 15mm Tube Insert  
S9920054 - 22mm Tube Insert

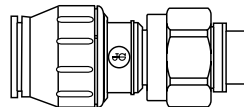

S9920063 - 15mm Tap Connector  
S9920064 - 22mm Tap Connector

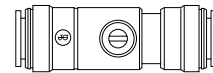

S9920072 - 22mm Tank Connector  
S9920073 - 15mm Tank Connector

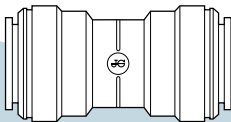

S9920055 - 15mm Straight Connector  
S9920056 - 22mm Straight Connector

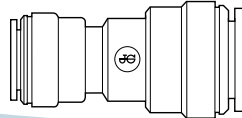

S9920065 - 15mm x 10mm Reducing Coupling  
S9920066 - 22mm x 15mm Reducing Coupling

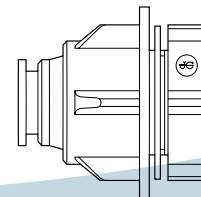

S9920067 - 15mm Stem Elbow

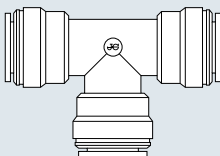

S9920057 - 22mm Tee  
S9920058 - 15mm Tee

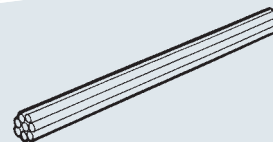

S9920084 - 3met x 15mm Barrier Pipe  
S9920085 - 3met x 22mm Barrier Pipe



## Plumbing Sundries

### KOPEX COPPER BENDS

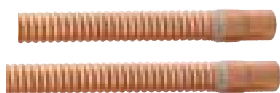

A corrugated copper pipe which the plumber can bend -cold-by hand.  
No special tool required  
Two patterns available

### PLAIN BOTH ENDS

S2700001  
400mm Long x 15mm  
S2700011  
550mm Long x 15mm  
S2700021  
550mm Long x 22mm

### WITH TAP CONNECTOR ONE END



S2700501  
300mm Long x 15mm  
S2700511  
400mm Long x 15mm  
S2700521  
550mm Long x 15mm  
S2700531  
350mm Long x 22mm  
S2700541  
550mm Long x 22mm

### P.T.F.E. TAPE



A positive sealing for all threaded pipe connections spools: 13mm wide, 40ft length

S2701001 - P.T.F.E Tape

### FLUXITE SOLDERING PASTE



S2701501 - 170gm Tin  
S2701511 - 450gm Tin  
S2701521 - 3kg Tin

### PLUMBERS HEMP

Long dressed white juice  
1kg Hank

S2702001 - 1kg Hank

### TARRED GASKIN

S2702501 - 50ft Length

### FULL BORE CRYSTALS

S2703001 - 7lb Tin  
S2703002 - 1kg Tub

### RUBBER TAP WASHERS

10 per pack  
S2703501  
For 13mm Taps  
S2703511  
For 19mm Taps

### BALLVALVE WASHERS



10 per pack  
S2704001  
For 13mm Valves  
S2704011  
For 19mm Valves

### POLYTHENE WASHERS



10 per pack  
S2704501  
For 13mm Taps  
S2704511  
For 19mm Taps  
S2704521  
For 32mm Basin Wastes  
S2704531  
For 38mm Bath Wastes  
S2704541  
For 38mm Sink Wastes

### TOP HAT SPACER WASHERS



10 per pack  
S2705001 - For 13mm & 19mm Taps

### POLYTHENE DIAPHRAGM WASHERS



For cistern syphons  
10 per pack  
S2705501  
Size: 115mm Diameter  
S2705511  
Size: 125mm Diameter

### NYLON SEATINGS FOR BSS BALLVALVES



10 per pack  
S2706001  
3mm Orifice (HP)  
S2706011  
5mm Orifice (MP)  
S2706021  
7mm Orifice (LP)  
S2706031  
8mm Orifice (Fullway)

### TAYMAR BLOW LAMP



Butane Gas with powerful wind resistant burner Ideal for paint stripping and Plumbing work RF80 cartridge included

S2706501  
Model LGB70 Blow Lamp

### REPLACEMENT CARTRIDGES

S2706551  
Model RF80 185g  
S2706561  
Model RF89 290g

### FLEXIBLE S/STEEL TAP CONNECTORS



S2700603  
15mm x 1/2" 300mm Long

### BENDING SPRINGS



For copper tube to BS.2871 Table 'X'

S2707501 - Size 15mm  
S2707511 - Size: 22mm  
S2707521 - Size: 28mm  
S2707531 - Size: 35mm

### JUBILEE CLIPS



S2601601  
Jubilee Clip Size 000  
S2601602  
Jubilee Clip Size 00  
S2601603  
Jubilee Clip Size 0  
S2601604  
Jubilee Clip Size 0X  
S2601605  
Jubilee Clip Size 1X  
S2601605  
Jubilee Clip Size 2X

### TUBE CUTTER



Suitable for cutting all types of light tubing alloy cutting wheel in three grades:  
WC for copper tubes  
WP for plastic tubes  
WH for stainless steel tubes  
Two models  
For tube sizes 4mm - 28mm OD

S2707001 - Type WC  
S2707003 - Type WH

For tube sizes 13mm - 44mm OD

S2707011 - Type WC  
S2707012 - Type WP  
S2707013 - Type WH



**Plumbing Sundries**

**POLYPROPYLENE CLEANING RODS**



Supplied as complete sets with 3ft rods and two tools Brass screwed joints

- S2708501 - 30ft Set
- S2708511 - 60ft Set

**FLEXIBLE SPRING WIRE CLEANERS**



Set comprises: Wood handle, Two 3ft spring wire rods  
Adaptor for fitting canes, Key for disconnecting

- S2709001 - Wire Cleaner

**RUBBER PLUNGER**



Rust proof handle 760mm long

- S2709501  
Size: 100mm Diameter
- S2709511  
Size: 150mm Diameter

**SINK WASTE CLEANER**



Made from 6mm diameter spring wire

- S2710001 - Size: 6ft Long
- S2710011 - Size: 12ft Long

**DRAIN TESTING PLUG**



- S2710501  
Size: 50mm Diameter x 13mm
- S2710511  
Size: 100mm Diameter x 13mm
- S2710521  
Size: 150mm Diameter x 13mm

**RUBBER FORCE CUP**



- S2711001 - Size: Small
- S2711011 - Size: Medium
- S2711021 - Size: Large

**CANVAS AIR BAG STOPPER**



Fitted with 54ins length of rubber tube and heavy brass valve

- S2711501  
For 100mm Diameter Pipes
- S2711511  
For 150mm Diameter Pipes

**HAND PUMP**

- For air bag stopper
- S2712001 - Hand Pump

**TAP BACKNUT WRENCH**



- S9902238  
To Suit 15mm + 22mm Backnuts

**WATER SOFTENERS**



- S7002700  
Water King 'WKI' Water Softener

**WATER SOFTENERS**



- S7002701  
Water King 'Sentry' Water Softener Pack

**AIR TESTING 'U' GAUGE KIT.**



Complete kit, except testing plug for carrying out air test to 100mm water gauge pressure on any size of drain or pipe.

- S2712005 - Testing Kit

**SMOKE EMITTER PELLETS**



For testing flue's, chimneys, fans etc. 60 sec. Burn time. 15cu.m volume

- S2712010 - Smoke Pellets

**DRAIN TESTER SMOKES**



White smoke testers for testing drains etc. works under water. 100sec.burn time, 80 cu.m volume.

- S2712015 - Drain Smokes

**DUAL ACTION FORCE PUMP**



Interchangeable cups for clearing blocked sinks, washbasins, baths, showers, urinals and w.c's.

- S2712020 - Force Pump

**CISTERMISER COMBI-MATE SCALE REDUCER**



- S2199043 - Scale Reducer

**SALT TABLETS**



- S2704021 - 25Kg Bag Salt Tablets (For Water Softener)

**Victorian Style (Complete with Matching Fitting Kit)**



- S6110000 - 'Harmonia 1' Towel Rail Chrome 952x675mm
- S6110001 - 'Harmonia 2' Towel Rail Chrome 952x800mm
- S6110002 - 'Harmonia 3' Towel Rail Chrome 952x940mm



S6110003 - 'Harmonia 7' Towel Rail Chrome 1500x584mm



Harmonia towel rails are suitable for indirect heating systems only.

Towel Rail Finishes Available

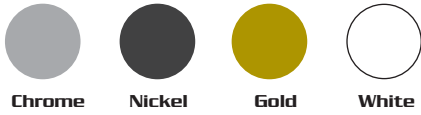

Radiator Colours Available

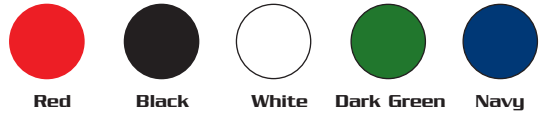

S6110004 'Diana 10' Towel Rail Chrome 965 x 533mm

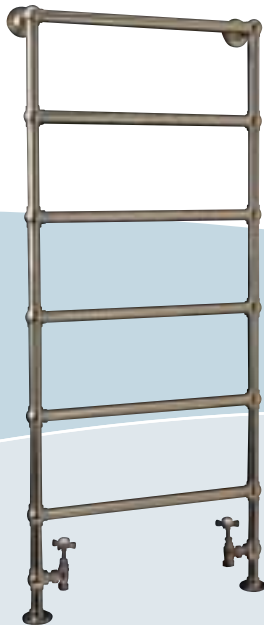

S6110006 'Bacchus 7' Towel Rail Chrome 1562 x 686mm

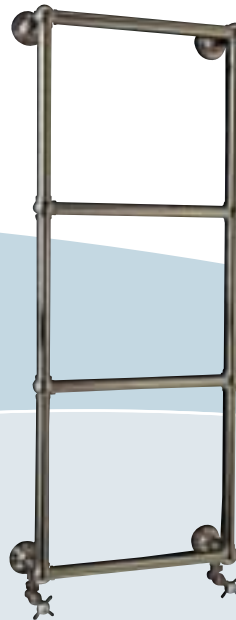

S6110007 'Diana 7' Towel Rail Chrome 838 x 533mm



S6110010 'Bacchus 8' Floor Standing Towel Rail Chrome 775 x 686mm (Depth=241mm)

Bacchus towel rails suitable for direct and indirect heating systems

Towel Rail Finishes Available



S6110008 'Diana 8' Towel Rail Chrome 990 x 533mm

S6110009 'Diana 9' Towel Rail Chrome 1296 x 533mm

'Diana' towel rails suitable for direct and indirect heating systems.



**Classic Style (Complete with Matching Fitting Kit)**



S6110011 - 'Bacchus 3' Towel Rail Chrome 952 x 990mm



Towel Rail Finishes Available



Chrome Nickel Gold White

**Contemporary Style (Complete with Matching Fitting Kit)**



S6110012  
'Imperia Curvo 4'  
Towel Rail Chrome,  
4 Curved Rails,  
2 Straight Rails  
1080 x 655mm



S6110013  
'Imperia Straight 4'  
Towel Rail Chrome,  
12 Straight Rails  
1080 x 655mm



Towel Rail Finishes Available



Chrome Nickel Gold White

'Imperia' towel rails are suitable for direct and indirect heating systems

**Designer Style (Fitting Kits are Extra)**



S6110014 - 'Apollo Straight' Towel Rail White 840 x 450mm  
S6110015 - 'Apollo Straight' Towel Rail White 840 x 600mm  
S6110016 - 'Apollo Straight' Towel Rail White 1134 x 450mm  
S6110017 - 'Apollo Straight' Towel Rail White 1134 x 600mm

Towel Rail Finishes Available



Chrome Coloured White

'Apollo' towel rails are available in most bathroom colours.



S6110022  
'Apollo' 15mm Angle  
Radiator Valves White (Pair)  
S6110023  
'Apollo' 15mm Straight  
Radiator Valves White (Pair)

S6110018 - 'Apollo Curvo' Curved Towel Rail White 840 x 450mm  
S6110019 - 'Apollo Curvo' Curved Towel Rail White 840 x 600mm  
S6110020 - 'Apollo Curvo' Curved Towel Rail White 1134 x 450mm  
S6110021 - 'Apollo Curvo' Curved Towel Rail White 1134 x 600mm

'Apollo' towel rails are suitable for indirect heating systems only.

All towel rails shown can be supplied as oil filled with electrical heating element if required, please request further information.

## Electric Water Heaters

### POINT OF USE MODELS

Small vented point of use water heaters are a popular means of providing hot water to a single sink or basin.



**S2952001** - 'Express' 7 ltr 3kw Complete with Spout and Valve

**S2952011** - 'Express' 15 ltr 3kw Complete with Spout and Valve



**S2952501** - 'Streamline' 7 ltr 3kw Heater Only for Use with Option Packs

**S2952501** - 'Streamline' 10 ltr 3kw Heater Only for Use with Option Packs

### OPTION PACKS (TO SUIT STREAMLINE)

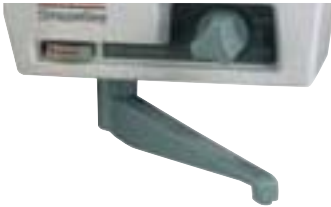

**S2953001**  
Pack B Domestic Spout and Valve



**S2953501**  
Pack C Telescopic Spout and Valve



**S2955001**  
Pack R Pair of Sink Pillars



**S2954001**  
Pack J Two Hole Deck Sink Mixer



**S2954501**  
Pack K Sink Monobloc Mixer

### UNVENTED MODELS



A sturdy 13.6ltr undersink water heater which can be used as an open outlet unit supplying a vented tap, or as a cistern fed unit supplying up to two ordinary taps provided a vent pipe is installed straight back to the header tank.

**S2950001** - UTC 1.5kw Storage Water Heater  
**S2950051** - UTC 3.0kw Storage Water Heater

Unvented systems are fed direct from the cold water mains supply and offer a number of major benefits compared with conventional systems. Including, higher pressure and flow rates at all hot taps, balanced supplies and no need for special taps.

Small unvented water heater ideal for any situation where two or more outlets are served from a single heater.

**S2950531** - 'Multipoint' 10ltr 3kw  
**S2950541** - 'Multipoint' 15ltr 3kw



A range of three sturdy large capacity wall mounted units operating on the displacement principal. Ideal for high demand dishwashing and similar applications.

**S2950501** - BCD (NP) B3 23ltr 3kw with Swivel Spout and Valve  
**S2950511** - BCD (NP) C3 55ltr 3kw with Swivel Spout and Valve  
**S2950521** - BCD (NP) D3 68ltr 3kw with Swivel Spout and Valve



## Electric Water Heaters

### UNVENTED MODELS

A range of value for money unvented water heaters to service one or more sinks or basins. The temperature and pressure relief valve (if required) must be ordered separately.

- S2950601 - 'Hotflo' 10ltr 2.2kw
- S2950602 - 'Hotflo' 15ltr 2.2kw

### ACCESSORY PACK (TO SUIT MULTIPPOINT AND HOTFLO UNITS)



S2950603 - Pack U6  
Temperature and Pressure Relief Valve (Use with 'Hotflo' Only)



S2950605 - Pack U1  
Combined Pressure Reducing Valve and Strainer



S2950604 - Pack U5  
Expansion Vessel Check Valve (Use with 'Hotflo' Only)



S2950606 - Pack U2  
Expansion Vessel Pressure Relief Valve, Check Valve. (Use with 'Multipoint' Only)



### 'MEGAFLO' UNVENTED DOMESTIC WATER HEATERS



- Internal air gap with unique floating baffle
- Strong light stainless steel construction
- No sacrificial anode (eliminates costly annual inspection)
- 3 Bar operating pressure
- Every unit tested to 15 bar.

'MegaFlo' units available to order only, please request further information from our sales office.

### CISTERN TYPE MODELS, SELF VENTING



Storage water heaters with an integral cistern are designed for plumbing direct to the rising main and provide a quick and easy solution to the need for Multipoint hot water supplies in situations where supply from a cold water storage tank or break tank is impractical.

Multipurpose integral cistern type heater for cloakrooms, canteens, kitchens and bathrooms.

- S2950607 - FBM25 25/13ltr 3kw
- S2950608 - FBM50 50/13ltr 3kw
- S2950609 - FBM75 75/18ltr 3kw
- S2950610 - FBM125 125/35ltr 3kw

### 'MEGALIFE' CISTERN FED STORAGE TANKS



'MegaLife' vented direct and indirect models are available to order. Please request further information from our sales office.



Cold Water Cisterns & Accessories

PC4R RECTANGULAR CISTERN PC25R RECTANGULAR CISTERN PC50R RECTANGULAR CISTERN



CAPACITY 4/18 GAL/LTR  
SIZE 442 L X 296 W X 305 H

- Z5010581 - Cistern PC4R
- Z5010586 - Rigid Lid RL4
- Z5010591 - Insulation Jacket  
60mm TJ4R60
- Z5011021 - Water Regulations Kit  
BK4R

CAPACITY 25/114 GAL/LTR  
SIZE 736 L X 584 W X 533 H

- Z5010584 - Cistern PC25R
- Z5010587 - Rigid Lid RL25
- Z5010592 - Insulation Jacket  
60mm TJ25R60
- Z5011022 - Water Regulations Kit  
BK25R

CAPACITY 50/227 GAL/LTR  
SIZE 1248 L X 568 W X 586 H

- Z5010585 - Cistern PC50R
- Z5010590 - Rigid Lid RL50
- Z5010595 - Insulation Jacket  
60mm TJ50R60
- Z5011023 - Water Regulations Kit  
BK50R

PC25C CIRCULAR CISTERN  
CISTERN

PC50C CIRCULAR CISTERN  
CISTERN (FLEXIBLE)

LT50 LOW LEVEL  
LOFT TANK



CAPACITY 25/114 GAL/LTR  
SIZE 686 D X 533 H

- Z5011001 - Cistern PC25C
- Z5011005 - Rigid Lid CL25
- Z5011008 - Insulation Jacket  
60mm TJ25C60
- Z5011030 - Water Regulations Kit  
BK25C

CAPACITY 50/227 GAL/LTR  
SIZE 838 D X 610 H

- Z5011002 - Cistern PC50C
- Z5011006 - Rigid Lid CL50
- Z5011009 - Insulation Jacket  
60mm TJ50C60
- Z5011031 - Water Regulations Kit  
BK50C

CAPACITY 50/27 GAL/LTR  
SIZE 1676 L X 483 W X 483 H

- Z5011003 - Cistern LT50
- Z5011010 - Insulation Jacket  
60mm TJ5060
- Z5011040 - Water Regulations Kit  
BKLT50

# New Impera Range of Sanitary Ware from **SISSONS**

The unique Quartsan material has been combined with stainless steel components to create the Impera product range. The stainless steel components are functional elements that add to the hard wearing image of the designs for toilets, urinal pods and washbasins.

The Impera range comprises five unique styles of sanitary ware ideally suited to commercial and institutional requirements.

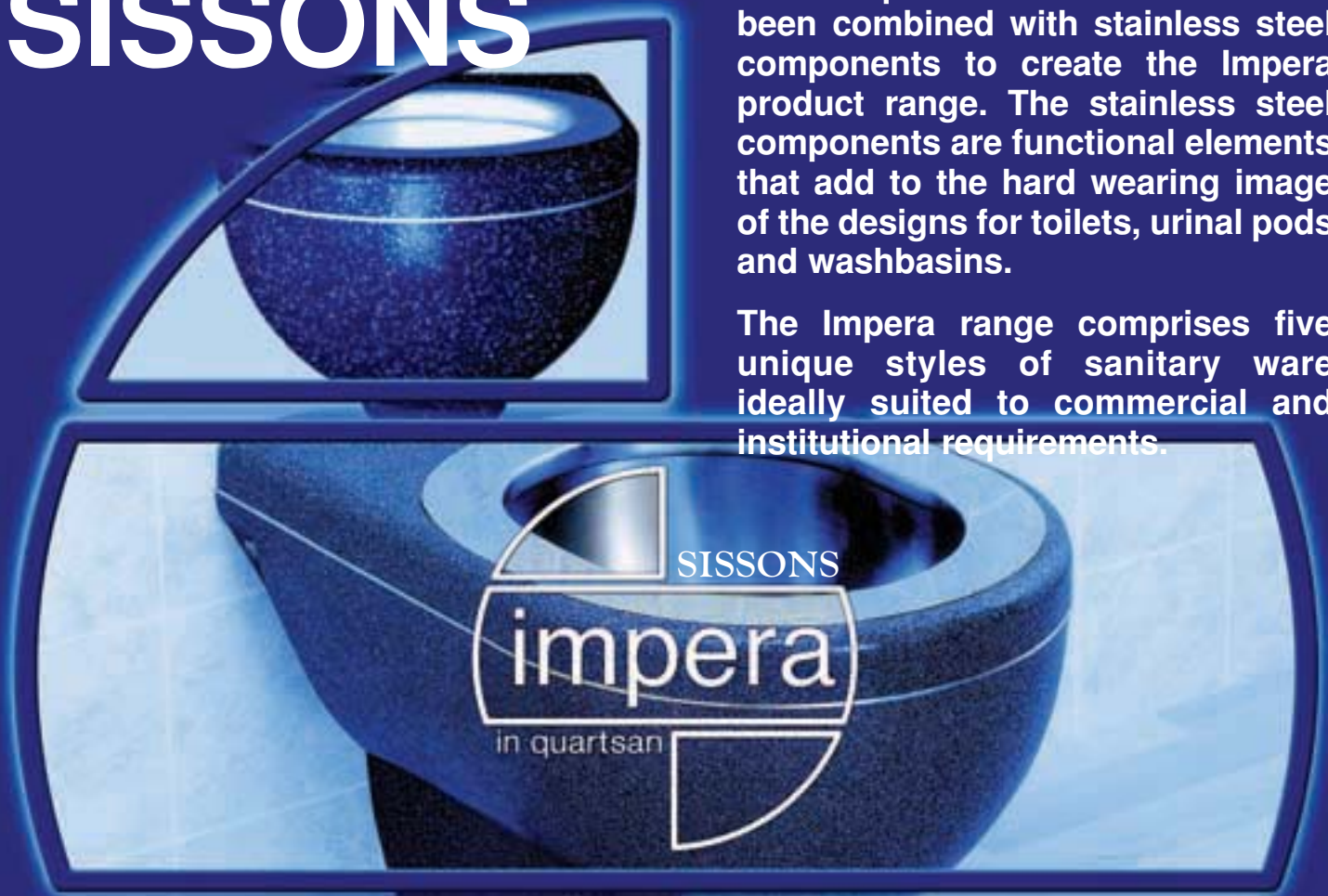

With the added element of colour, Impera products are suitable for prisons, police cells, magistrates courts, motorway services, stadia, public toilets, leisure centres, offices and commercial buildings.

## SISSONS

W & G Sissons Limited Carrwood Road Sheepbridge Chesterfield S41 9QB

## Wash Basins

This section of our catalogue depicts a wide range of stainless steel products which couple durability and strength with cutting edge design. Ideally suited to public conveniences, prisons, schools, hospitals and public washrooms. The majority of the products shown are available ex-stock.

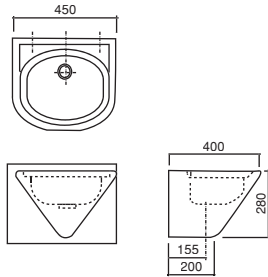

Wall mounted wash basin designed for duct wall fixing so that the pipework/connections are all hidden from view. This basin incorporates a fully welded shroud.

- S2190006 - Basin Complete With 32mm Flush Grated Waste Tapholes 2
- S2101502 - Basin Complete with 32mm Flush Grated Waste No Tapholes
- S2101503 - Basin Complete with 32mm Flush Grated Waste RH Taphole
- S2101504 - Basin Complete with 32mm Flush Grated Waste LH Taphole

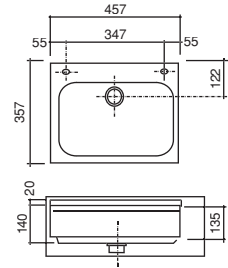

Wall hung basin with large rectangular bowl and fitted with an apron support. (bowl size 410 x 265 x 140mm)

- S2103001 - Basin with Apron Support 457 x 357mm Tapholes 2
- S3020551 - 32mm Combined Waste, Overflow, Plug and Chain

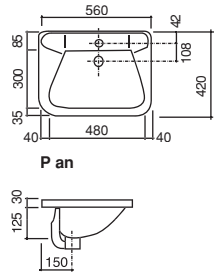

Wall mounted wash basin with smooth radius corners and two soap recesses. This basin is available as one taphole only.

- S2102001 - Basin Complete with Wall Mounting Brackets 32mm Combined Waste, Overflow, Plug and Chain.

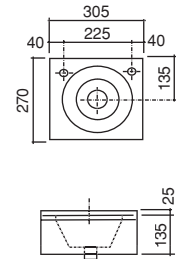

Compact wall hung wash basin with round bowl. Fitted with an apron support. (Bowl size 230 x 135 x 155mm)

- S2103501 - Basin with Apron Support 305 x 270mm Tapholes 2
- S2103511 - 32mm Waste, Plug and Chain.

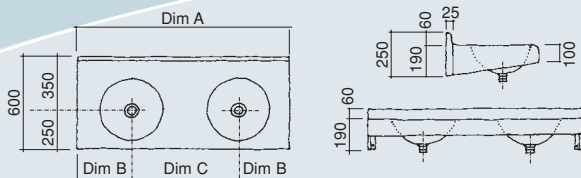

Multiple wash hand basins incorporating circular bowls with two tapholes per bowl. Available square or rolled front. (Alternative sizes and taphole variations to special order)

- S2102501 - Range of Two Basins Roll Front (Two Tapholes per Bowl) 1200 x 600mm
- S2102511 - Range of Three Basins Roll Front (Two Tapholes per Bowl) 1800 x 600mm
- S2102521 - Range of Two Basins Square Front (Two Tapholes per Bowl) 1200 x 600mm
- S2102531 - Range of Three Basins Square Front (Two Tapholes per Bowl) 1800 x 600mm

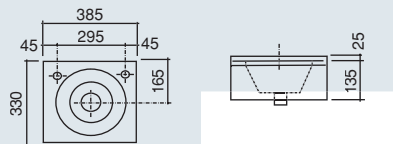

This bowl is slightly larger than S2103501 and incorporates an overflow facility (Bowl size 305 x 190 x 145mm)

- S2103521 - Basin with Apron Support 385 x 330mm Tapholes 2
- S3020551 - 32mm Combined Waste, Overflow, Plug and Chain.

For Taps and Mixers See Page 54 - 66 and 179 - 186



## Inset Wash Basins

A range of wash basins designed for fitting into worktops. They are ideally suited to installations such as public conveniences, kitchens, food shops, cloakrooms, vanitory units and other locations where hand washing is subject to health regulations.



- S2104001** - Inset Basin 420 x 400mm Tapholes 2
- S3020551** - 32mm Combined Waste, Overflow, Plug and Chain.

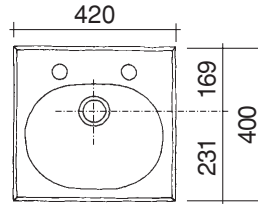

- S2104501** - Inset Basin 520 x 340mm No Tapholes Complete with 32mm Waste, Plug, Chain and Overflow.

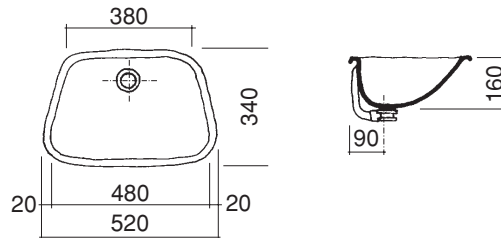

- S2104601** - Round Inset Basin 400mm Dia. Tapholes 2
- S2104602** - Round Inset Basin 440mm Dia. Tapholes 2
- S3020551** - 32mm Combined Waste, Overflow, Plug and Chain.

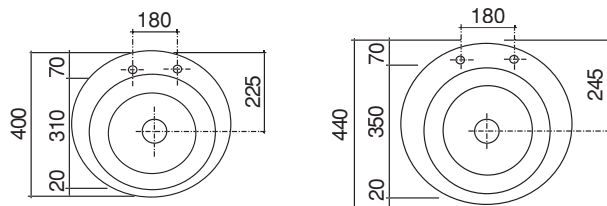

- S2104603** - Inset Basin Highly Polished Bowl 460mm Dia. Taphole 1, Complete with Waste, Plug, Chain and Overflow.

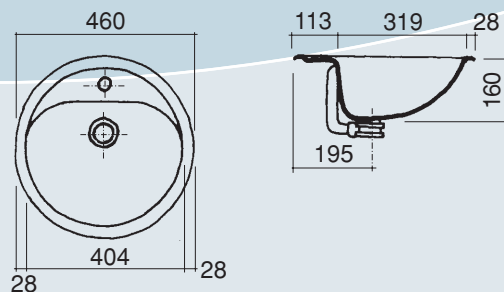

Stainless Steel

For Taps and Mixers See Page 54 - 66 and 179 - 186

W.C. Suites

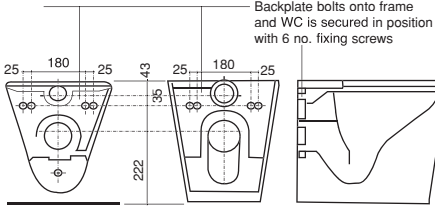
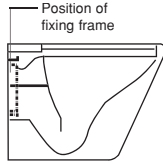

The increasing use of wall installation frames for mounting WC's require a product that use fixing points and waste water outlets suited to frames systems. This W.C. pan is supplied with push fit bracket for front fixing. Can be supplied drilled for use with toilet seat if required.

- S2166001 - Push Fit Wall Mounted W.C. Pan with 'P'trap
  - S2166501 - Push Fit Floor Mounted W.C. Pan with 'P'trap
- See Page 148-149 For our Wall installation Frames.

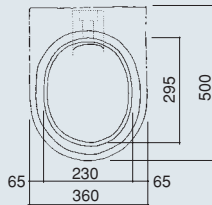
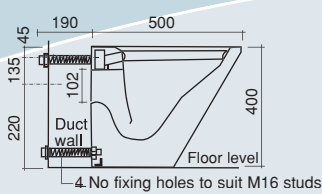

Floor mounted back to wall W.C. for use with concealed cisterns. The fully welded shroud conceals all pipework and provides a solid fixing point for added security. As with our wall hung W.C. the shallow depression of the flushing rim eliminates the need for a toilet seat should it not be required.

- S2190011 - Floor Mounted W.C. Pan with 'P' Trap
- S2190004 - Floor Mounted W.C. Pan with 'P' Trap Drilled For Toilet Seat.

See Page 144 For our Selection of Concealed Cisterns

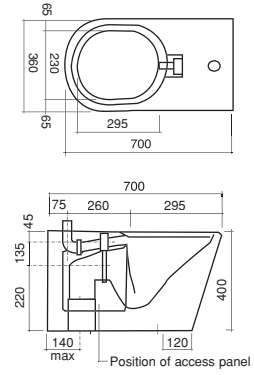

Floor mounted W.C. with 'S' trap, the shroud conceals all pipework, fixings are made using the removeable access panels in the shroud wall. This model can only be used with a surface mounted cistern. Supplied drilled for toilet seat or undrilled if seat not required.

- S2166002 - Floor Mounted W.C. Pan with 'S' Trap
  - S2166003 - Floor Mounted W.C. Pan with 'S' Trap Drilled for Toilet Seat
  - S2166004 - 6 Ltr Stainless Steel Cistern For Surface Mounting
  - S2166005 - 38mm O/D Stainless Steel Downpipe.
- See Page 143 For Alternative Surface Mounted Cisterns.



- S2190005 - Black Seat and Lid with Security Fixings
- S2190012 - Black Seat Only with Security Fixings

All W.C.'s shown on this page can be supplied with seat pads fitted, to special order.

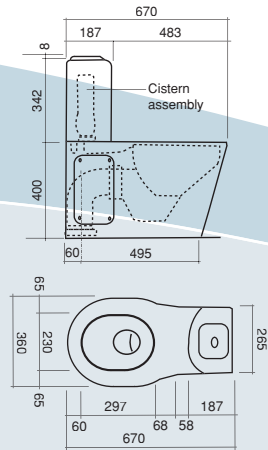

Close coupled W.C. The cistern is push button control with 6 ltr flush. This W.C. is supplied ready assembled with horizontal outlet, fixing is via the two side access panels. A neat, hygienic and easy to maintain W.C.

- S2166006 - Floor Mounted Close Coupled W.C. No Seat or Lid.
- S2166007 - Floor Mounted Close Coupled W.C. with Seat and Lid Plus Security Fixings.



Urinals

FULLY PRESSED WALL HUNG URINALS



Please Order Automatic Cistern Separately See Page 143

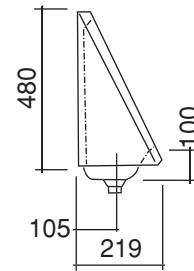
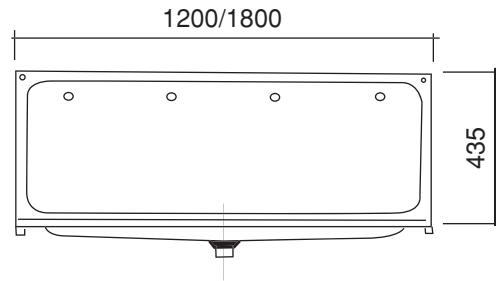

Fully pressed wall hung urinal, economically priced for use with exposed or concealed automatic cisterns. Supplied with downpipe, 38mm waste and button spreaders. Waste outlet is centrally positioned. 450mm Overall height.

- S2193001 - 1200mm Pressed Wall Hung Trough Urinal
- S2193011 - 1800mm Pressed Wall Hung Trough Urinal

WALL HUNG SLAB URINALS

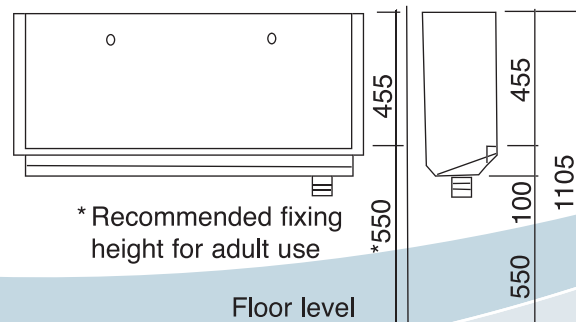
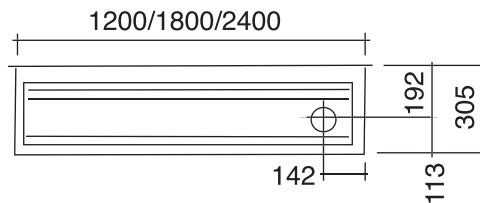

Wall hung slab urinal, highly vandal resistant and hygienic. Supplied complete with plastic automatic cistern, downpipe, spreaders, end infills and 50mm waste outlet.

- S2192501 - 1200mm Trough Urinal Complete Left Hand Outlet
- S2192502 - 1200mm Trough Urinal Complete Right Hand Outlet
- S2192511 - 1800mm Trough Urinal Complete Left Hand Outlet
- S2192512 - 1800mm Trough Urinal Complete Right Hand Outlet

Our range of stainless steel urinals can be manufactured to any shape and size if required. Stainless steel automatic cisterns can also be ordered as an alternative to plastic.

Stainless Steel

Urinals

FLOOR STANDING SLAB URINALS

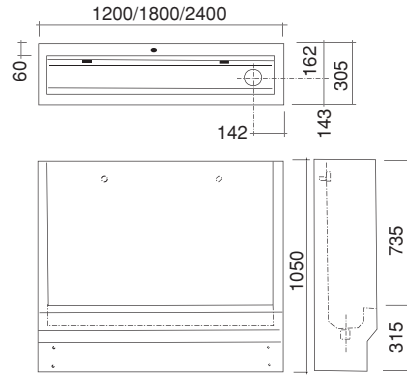

Floor standing slab urinals, highly vandal resistant and hygienic. This slab urinal has a removeable front access panel for access to waste pipework. Supplied complete with plastic automatic cistern, downpipe, spreaders and 50mm waste outlet.

- S2191001 - 1200mm Floor Standing Urinal Complete Left Hand Outlet
- S2191002 - 1200mm Floor Standing Urinal Complete Right Hand Outlet
- S2191011 - 1800mm Floor Standing Urinal Complete Left Hand Outlet
- S2191012 - 1800mm Floor Standing Urinal Complete Right Hand Outlet
- S2191021 - 2400mm Floor Standing Urinal Complete Left Hand Outlet
- S2191022 - 2400mm Floor Standing Urinal Complete Right Hand Outlet

FLOOR RECESSED SLAB URINALS

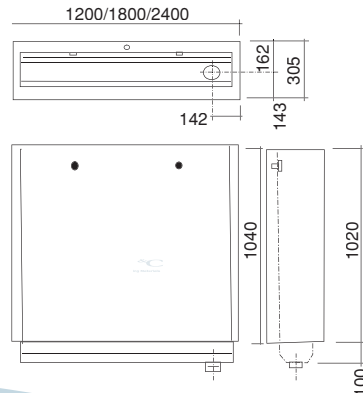

Floor recessed slab urinal, highly vandal resistant and hygienic, being floor recessed means adjacent floor area can be hosed down into the trough. Supplied complete with plastic automatic cistern, downpipe, spreaders and 50mm waste outlet.

- S2191023 - 1200mm Recessed Slab Urinal Complete Left Hand Outlet
- S2191024 - 1200mm Recessed Slab Urinal Complete Right Hand Outlet
- S2191025 - 1800mm Recessed Slab Urinal Complete Left Hand Outlet
- S2191026 - 1800mm Recessed Slab Urinal Complete Right Hand Outlet
- S2191027 - 2400mm Recessed Slab Urinal Complete Left Hand Outlet
- S2191028 - 2400mm Recessed Slab Urinal Complete Right Hand Outlet

Our range of stainless steel urinals can be manufactured to any shape and size if required. Stainless steel automatic cisterns can also be ordered as an alternative to plastic.

Stainless Steel

URINAL PODS

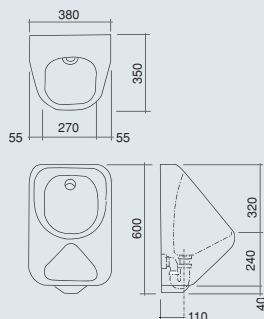

Urinal pod for duct or surface mounted cisterns. The pod shroud conceals all pipework making it easy to clean, hygienic and vandal resistant. Supplied complete with spreader, domed grated waste and trap.

- S2190000 - Urinal Pod for Duct Mounted Cisterns
- S2189000 - Urinal Pod for Surface Mounted Cisterns.
- S2190003 - S/Steel Downpipe for single pod
- S2189001 - S/Steel Downpipe for Two Pods
- S2189002 - S/Steel Downpipe for Three Pods
- S2189003 - S/Steel Divider Panel

See Page 143 for our Selection of Automatic Cisterns.

Commercial Sinks



Small inset sink bowls for inseting into worktops. Manufactured from 304 grade s/steel. Brushed polished finish. Supplied complete with fixing clips.

- OVERALL SIZE BOWL SIZE**  
**S3020001 - SB460** Inset Bowl. 500x380mm 460x340x180mm  
**S3020011 - SB460D** Inset Bowl. 500x380mm 460x340x250mm  
**S3020021 - SB22** Inset Bowl. 597x419mm 560x380x180mm  
**S3020031 - SB22D** Inset Bowl. 597x419mm 560x380x250mm  
**S3020051 - 38mm Combined Waste, Overflow, Plug and Chain for above**

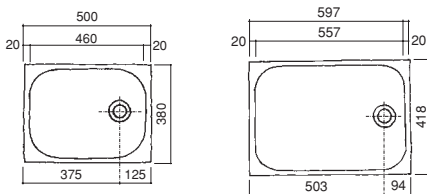

Round inset sink bowls for inseting into worktops. Manufactured from 304 grade s/steel brushed polished finish. Supplied complete with fixing clips.

- S3020501 - RB1 Round inset Bowl 355mm O/D. 160mm Deep**  
**S3020511 - RB2 Round inset Bowl 430mm O/D. 160mm Deep**  
**S3020521 - RB3 Round inset Bowl 482mm O/D. 190mm Deep**  
**S3020551 - 32mm Combined Waste, Overflow, Plug and Chain for above.**

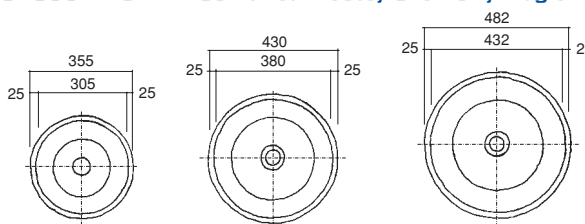

Utility sink. All purpose wall hung wash basin ideal for washing, rinsing and cleaning in locations such as garages, laundry rooms and utility rooms. Complete with 38mm waste and trap.

- S3021001 - Small Utility Sink 480 x 380 x 190mm**  
**S3021011 - Medium Utility Sink 555 x 455 x 230mm**  
**S3021021 - Large Utility Sink 655 x 505 x 250mm**

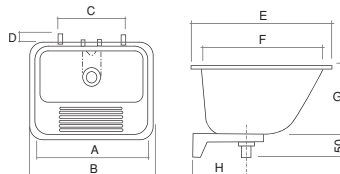

	A	B	C	D	E	F	G	H
Small	440	485	240	25	385	340	190	150
Medium	500	555	320	25	455	400	230	185
Large	600	655	380	25	505	450	250	200



Bucket sinks are suitable for kitchens, cleaners rooms or workshops where there is a need for disposing of dirty water. There are two models available one which is wall hung. The other with front leg supports. Both are supplied complete with a domed waste and s/steel splashback. The hinged grid needs to be ordered seperately for the wall hung bucket sink.

- S3021501 - Wall Hung Bucket Sink 490 x 390 x 175mm**  
**S3021502 - Hinged Grid for above**  
**S2190010 - Floor Standing Bucket Sink Complete 500x520x180mm**  
**S2190009 - Stainless Steel Bucket (For use with Both Models)**

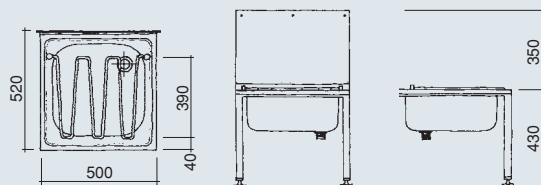
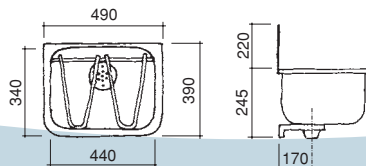

Stainless Steel

Commercial Products



JANITORIAL UNIT

This unit combines both bucket, sink and washbasin into a single unit. The unit comes complete with legs, flush grated wastes and monobloc mixer fitting. The unit is shrouded with front access panel for plumbing.

**S2190008** - Janitorial Unit Complete with 38mm Wastes and Tap

**S2190009** - Stainless Steel Bucket

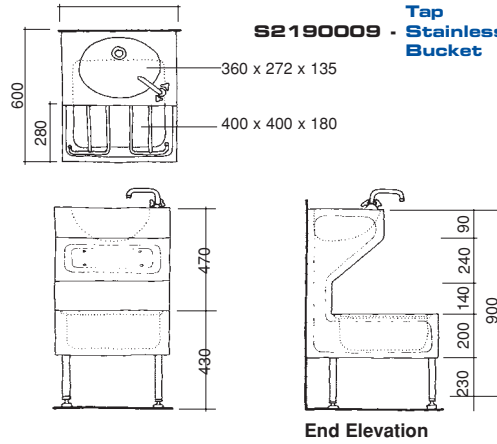

STAINLESS STEEL DRINKING FOUNTAINS

**S2190014** - Pedestal Mounted Drinking Fountain



**S2190013** - Wall Hung Drinking Fountain

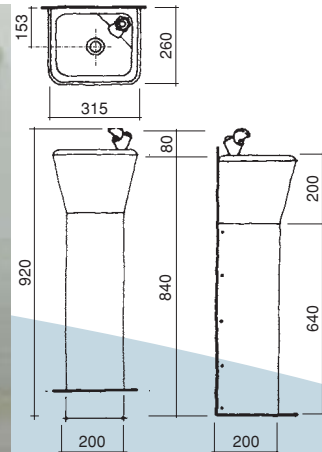
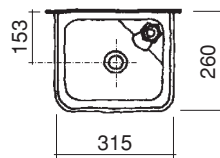

WASH TROUGH

Fully pressed wash trough which is wall fixed by two partially concealed brackets. Supplied complete with a centrally positioned 38mm waste outlet. Splashbacks are extra if required.

**S2106001** - 1200x430mm Wash Trough

**S2106002** - 1800x430mm Wash Trough

**S2106003** - 1200x150mm Splash Back

**S2106004** - 1800x150mm Splash Back

These wash troughs are special order items and can be supplied with or without tap ledge.



Commercial Products



'Sanistrel' sanitary towel dispenser. These units can be installed surface mounted or recessed. Trim kit should be ordered if unit is to be recessed. A double entry version is available to serve two rooms with a common hall.

- S2104701 - Stainless Steel Sanitary Towel Dispenser
- S2104702 - Stainless Steel Double Entry Sanitary Towel Dispenser
- S2104703 - Stainless Steel Trim Kit.

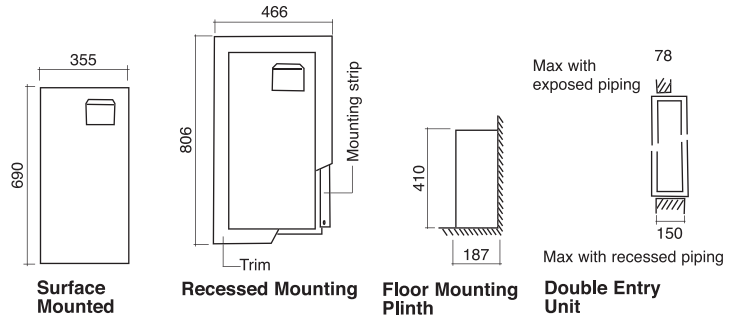

Nappigon- Nappy disposal machine. Quick, easy, clean and economical. Ideally suited to baby changing rooms. Under an automatic flow of water the nappies are shredded into fine particles and flushed away into the main drainage system.

- S2104704 - 'Nappigon' Disposal Machine 400x600x900mm

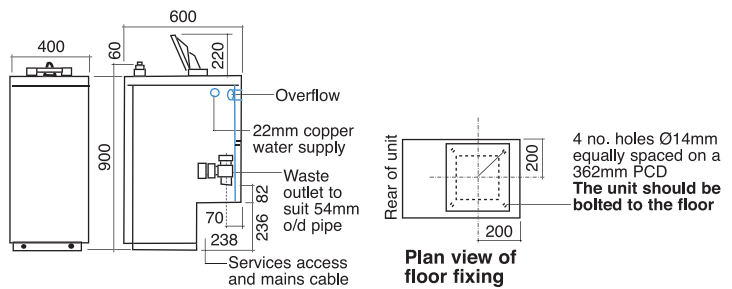

- S2104705 - Mixer Unit 13mm Chrome with Overhead Spray

For Alternative Commercial Taps and Mixers See Page 183



## Commercial Sinks

### CATERING SINKS WITH STANDS



- Manufactured from type 304 18/8 Stainless Steel.
- All visible surfaces polished
- Underframes and valances made from type 430 stainless steel
- Stainless Steel under shelf
- Square section legs with adjustable plastic feet
- Each bowl is fitted with 38mm BSP waste and stand pipe
- Bowl size: 610 x 460 x 300mm deep
- working height: 850mm from floor

### SINGLE BOWL, DOUBLE DRAINER

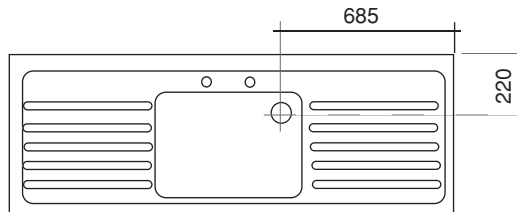

S3026001 - Overall Size: 1800 x 650mm

### DOUBLE BOWL, SINGLE DRAINER

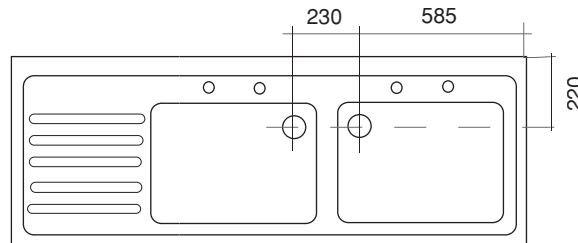

S3026501 - Overall Size: 1800 x 650mm R/H Drainer

S3026502 - Overall Size: 1800 x 650mm L/H Drainer

### SINGLE BOWL

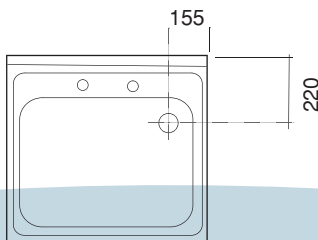

S3025001 - Overall Size: 750 x 650mm

### DOUBLE BOWL, DOUBLE DRAINER

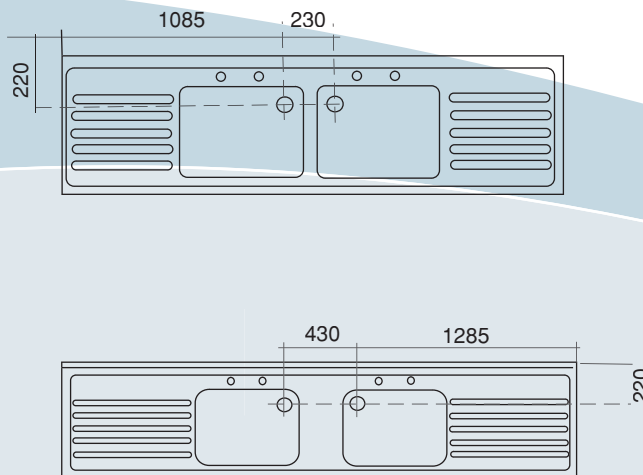

S3027001 - Overall Size: 2400 x 650mm

S3027011 - Overall Size: 3000 x 650mm

### SINGLE BOWL, SINGLE DRAINER

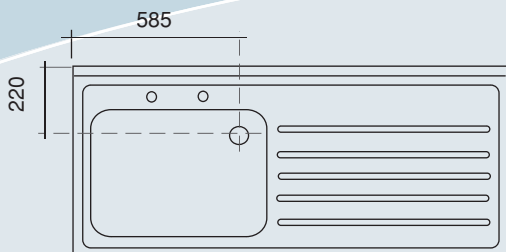

S3025501 - Overall Size: 1200 x 650mm R/H Drainer

S3025502 - Overall Size: 1200 x 650mm L/H Drainer

S3025511 - Overall Size: 1500 x 650mm R/H Drainer

S3025512 - Overall Size: 1500 x 650mm L/H Drainer

## Commercial Products

### CATERING TABLE



- Preparation table made from 304 grade stainless steel
- Bright polished finish
- Floor mounted on stainless steel legs
- Stainless steel undershelf included

S3023501 - Table Size: 900 x 650mm

S3023511 - Table Size: 1200 x 650mm

S3023521 - Table Size: 1500 x 650mm

S3023531 - Table Size: 1800 x 650mm

### BAR SINK WITH TWIN BOWLS



- Hand fabricated from 304 grade stainless steel
- Bright polished finish
- 35mm high upstand with anti-drip moulding
- Two taphole punching for mixer serving both bowls
- Supplied complete with Waste and Overflows
- Bowl size: 460 x 350 x 250mm deep

S3022041 - Bar Sink Size: 1800 x 500mm

Extra for:

S3022042 - Under Frame and Shelf for above

### STAINLESS STEEL PRODUCTS

We have detailed in our stainless steel section a comprehensive range of products which whilst being resistant are designed with aesthetic qualities in mind. The full range of stainless steel products available is endless. Catering furniture, preparation sinks, hospital sluices and slop hoppers to name a few.

It is also possible to fabricate special items to order. If you cannot find a product to suit your need within our range please contact our sales office for further information and all of your stainless steel requirements.

### CLEANING OF STAINLESS STEEL.

To maintain the original surface finish of stainless steel, it needs to be cleaned regularly with soapy water or non-abrasive cleaners. Bleach or other strong acids should not come into contact with stainless steel as it harms the surface which causes staining and pitting

## New Impera Range of Sanitary Ware from SISSONS

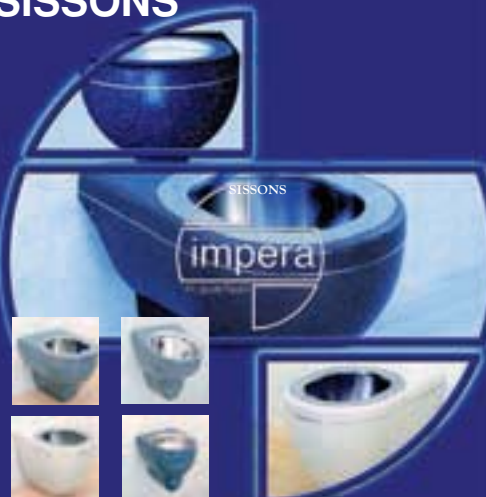

Available from N & C

Stainless Steel

**Plan Oven** (bottom right):

New cooking functions with electronic controls and a Safe Cool Touch System that keeps the door's temperature at less than 40°C.

**Plan Dishwasher** (bottom left):

An A class performance.  
Perfect cleaning and drying guaranteed.  
Quiet operation.

**Plan Hob:**

5 burner gas hob with triple ring burner and flame failure device.

**Plan Microwave Oven:**

3 cooking options (microwave, grill, microwave plus grill).  
Easy access drop down door.

**Plan Cooker Hood:**

An elegant design combined with powerful extraction - 4 speed settings.  
Back lit with electronic controls.



**The Candy Plan Range**  
It's impossible to spoil the effect



New Chester Road, Bromborough,  
Wirral, Merseyside CH62 3PE.

**CANDY**



# N&C *Olympus*



## Kitchens

The following pages highlight some of the many different aspects of kitchens and kitchen accessories for either developers, local authorities or retail customers.

- Local authority specification from stock ● Economy kitchens
  - High specification kitchens ● Special needs kitchens
  - Kitchen accessories ● Sinks ● Worktops ● Appliances

**Broadgate City Range**

The classic style full length polished anodised 'G' handled trim. Tongue and grooved fitting glued into 15mm white melamine facia. Clean simple low maintenance



**BASE UNITS**

1 x Door 1 x Drawer 1 x Shelf

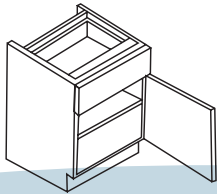

Size 300 W x 500 D S3260014 - LHH S3260013 - RHH	Size 400 W x 500 D S3260016 - LHH S3260015 - RHH	Size 500 W x 500 D S3261012 - LHH S3261011 - RHH	Size 600 W x 500 D S3261016 - LHH S3261015 - RHH
Size 300 W x 600 D S3260018 - LHH S3260017 - RHH	Size 400 W x 600 D S3260020 - LHH S3260019 - RHH	Size 500 W x 600 D S3261002 - LHH S3261001 - RHH	Size 600 W x 600 D S3261014 - LHH S3261013 - RHH

**SINK UNITS**

2 x Doors 1 x Drawer 1 x Dummy Draw 1 x Shelf

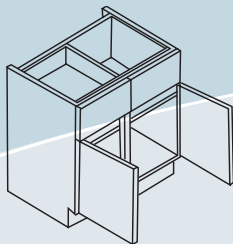

Size 1000 W x 500 D S3260012 - LHD S3260011 - RHD
Size 1000 W x 600 D S3260002 - LHD S3260001 - RHD

**DRAW UNITS**

4 x Drawers

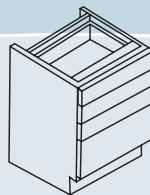

Size 500 W x 500 D S3263011
Size 500 W x 600 D S3263001
Size 600 W x 500 D S3263012
Size 600 W x 600 D S3263002

**DOUBLE BASE UNITS**

2 x Doors 2 x Drawers 1 x Shelf

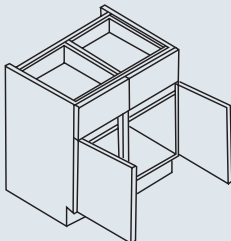

Size 800 W x 500 D S3261017
Size 800 W x 600 D S3261018
Size 1000 W x 500 D S3262011
Size 1000 W x 600 D S3262001

**UNDER OVEN**

Supplied with a Matching Filler Panel

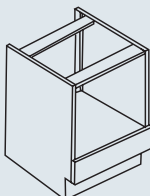

Size 600 W x 600 D S3266002
--------------------------------

Bronze Specification

Kitchens



## Broadgate City Range

### CORNER BASES

1 x Door 1 x Drawer 1 x Shelf

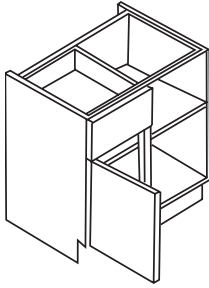

Size 800 W x 500 D  
S3264022 - LHB  
S3264021 - RHB

Size 800 W x 600 D  
S3263902 - LHB  
S3263901 - RHB

Size 1000 W x 500 D  
S3264012 - LHB  
S3264011 - RHB

Size 1000 W x 600 D  
S3264002 - LHB  
S3264001 - RHB

### TALL STORAGE UNITS

2 x Doors 4 x Shelves

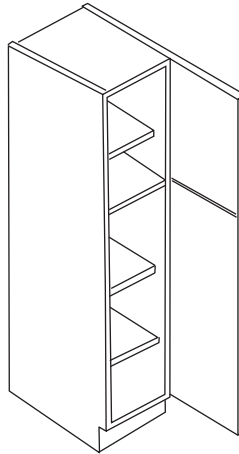

Size 500 W x 500 D x 1975 H  
S3265022 - LHH  
S3265021 - RHH

Size 500 W x 600 D x 1975 H  
S3264032 - LHH  
S3264031 - RHH

Size 500 W x 500 D x 2120 H\*  
S3265034 - LHH  
S3265033 - RHH

Size 500 W x 600 D x 2120 H\*  
S3265032 - LHH  
S3265031 - RHH

### APPLIANCE HOUSINGS

Various Sizes door and filler combinations supplied

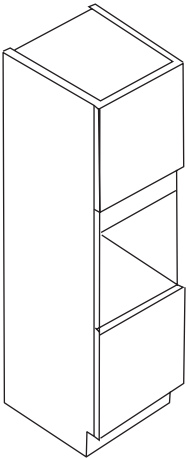

Size 600 W x 600 D x 1975 H  
S3266003 - LHH  
S3266001 - RHH

Size 600 W x 600 D x 2120 H\*  
S3266022 - LHH  
S3266023 - RHH

### Top Box

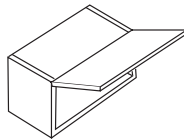

Size 500 W x 290 H  
S3267007

Size 600 W x 290 H  
S3267008

### Corner Wall Units

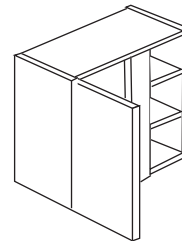

Size 600 W x 575 H  
S3267102 - LHH  
S3267101 - RHH

Size 600 W x 720 H\*  
S3268102 - LHB  
S3268101 - RHB

### Single Wall Units 575 High

1 x Door 1 x Shelf

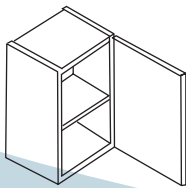

Size 300 W x 575 H  
S3266902 - LHH  
S3266901 - RHH

Size 400 W x 575 H  
S3266904 - LHH  
S3266903 - RHH

Size 500 W x 575 H  
S3267002 - LHH  
S3267001 - RHH

Size 600 W x 575 H  
S3267004 - LHH  
S3267003 - RHH

### Double Wall Units 575 High

2 x Door 1 x Shelf

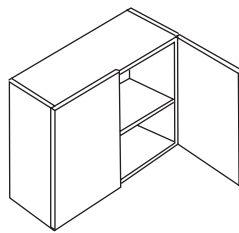

Size 800 W x 575 H  
S3267005

Size 1000 W x 575 H  
S3268001

### Single Wall Units 720 High\*

1 x Door 2 x Shelves

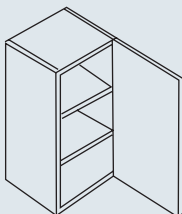

Size 300 W x 720 H  
S3267902 - LHH  
S3267901 - RHH

Size 400 W x 720 H  
S3267904 - LHH  
S3267903 - RHH

Size 500 W x 720 H  
S3267906 - LHH  
S3267905 - RHH

Size 600 W x 720 H  
S3267908 - LHH  
S3267907 - RHH

### Double Wall Units 720 High\*

2 x Door 2 x Shelves

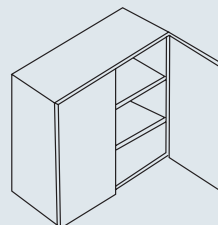

Size 800 W x 720 H  
S3268005

Size 1000 W x 720 H  
S3269002

\* 720 high wall units and 2120 high tall units are not generally stocked. Please ask for details

**Country Range**

Traditional style continuous full length wooden handles in honey oak, limed oak, mahogany 'G' handle or alternatively beech 'J' style handle. Tongue and groove fixed into 15mm melamine fascia



Blue Alder with limed Oak 'G' handle



White with Mahogany 'G' handle



Green Alder with limed oak 'G' handle



Can Can with Beech 'J' handle



Swiss pear with Honey Oak 'G' handle



Parchment with Medium Oak 'G' handle

## Moorland Range

A selection of modern melamine faced, 18mm chipboard fascias, edged all round with tough, safe, impact resistant 3mm ABS edging



Moorland Green Alder with Profile handles



Moorland Parchment with Bow handles



Moorland Blue Alder with Profile handles



Moorland Titanium with Chrome 'D' handles



Moorland Swiss Pear with Chrome 'D' handles

### MOORLAND HANDLE CHOICES:



Bow handle



Chrome 'D' handle



Profile handle



## Highland Range

Three individual door styles each with their own character and charm.

### IVORY



Classic design, barrel effect, ivory colour door with cup pull handles and complementary 'D' door handles.

### CATHEDRAL WHITE



Traditional cathedral arched white foil door with matching pewter knob and backplate

### SAPONETTA PEAR



Ultra modern smooth sophisticated swiss pear foil door (handle shown for illustrative purposes only)

#### HIGHLAND HANDLE CHOICES:

Ivory



Cup Pull Drawer and complimentary 'D' door handle

Cathedral White

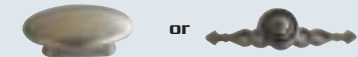

Brushed Oval Knob

Pewter Knob and backplate

Saponetta Pear



T-Bar

Large 'D' handle

## Lakeland Range

A traditional shaker designed swiss pear panel door with an exciting selection of alternative inset decor panels in a variety of fashionable colours.



Copper Swirl inset door panel with Copper Knob

Silver Specification



Techno with Large 'D' handle



Blue with Large 'D' handle



Green with 'T' Bar handle



Swiss Pear with 'T' Bar handle



Titanium with 'T' Bar handle

**LAKELAND HANDLE CHOICES:**

All doors have a choice of T-Bar or Large 'D' handle

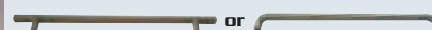

T-Bar

Large 'D' handle

Copper swirl also has a copper knob option



Copper Knob



## Specification for Bronze and Silver kitchens

Bronze and Silver specification units are on a 15mm ready assembled carcass on either a white gable end unit or a white or swiss pear box-on-legs carcass. The relevant handles are incorporated into the price.

### CONSTRUCTION

Cam & dowel, fully repairable. Tested by FIRA to conform to BS 6222 (1997) Pt 2 Level H. FIRA Gold Award and BSI Kite Mark for Quality.

### CARCASE MATERIAL

All panels are manufactured from 15mm fine surface chipboard to BS EN312-1&3.

Type P3 faced in 80 kg/m<sup>2</sup> melamine, to comply to the requirements of BS EN7331.

Tested to conform to BS 6222 Part 3:1999 for surface finish.

All exposed edges are lipped with melamine. Bonded with hot melt adhesive.

### RAILS & MUNTINGS

Front rails and vertical muntings MDF fully wrapped with white foil. Cross muntings are chipboard fully wrapped with white foil.

### DRAWER SYSTEM

White epoxy coated metal box drawer, featuring metal with 15mm MFC chipboard base and back, fully adjustable all metal front fascia mounting brackets. All metal runners have nylon rollers, integrated stop and self - closing action.

### HINGES

Metal four-way adjustable self-closing 170 degree clip-on hinges. Metal mounting plates are secured to carcass by 5mm machine screws.

### PLINTH

Base units have removable plinths for access.

### FASCIAS

Door and drawer fascias are all fully adjustable on drawerline base doors. Double handed fully interchangeable with standard wall units

### BRACKETS

All metal brackets manufactured from zinc plated steel to BS 1706 1990 resistant to corrosion.

Nylon patented corner brackets to front top rail secured by 5mm machine screws for strength and durability.

Concealed fully adjustable wall hanger system to wall units.

### HARDBOARD BACK

Removable inset hardboard backs to all units with a 70mm void (600mm deep units) to all base and tall units for service cavity.

### METAL DOMES

Where adjustable legs are not included, metal domes are fitted to the bottom of gable ends of ready assembled units, to prevent damage during transit and fitting.

### SHELVES

Fully adjustable legs for height, supported on nylon shelf pegs, central support provided for all double units to prevent deflection.

### RANGE OPTIONS

RANGE	GABLE END (500 OR 600 DEEP) + OPTIONAL LEGS ON WHITE CARCASE	BOX-ON-LEGS (600 DEEP) ON WHITE OR SWISS PEAR CARCASE
BROADGATE	✓	OPTIONAL
COUNTRY	✓	OPTIONAL
MOORLAND	OPTIONAL	✓
HIGHLAND	OPTIONAL	✓
LAKELAND	OPTIONAL	✓



BS 6222 part 2:1997 level 'H'  
Licence no. KM 59267



## Specification for Bronze and Silver kitchens

### 600MM DEEP

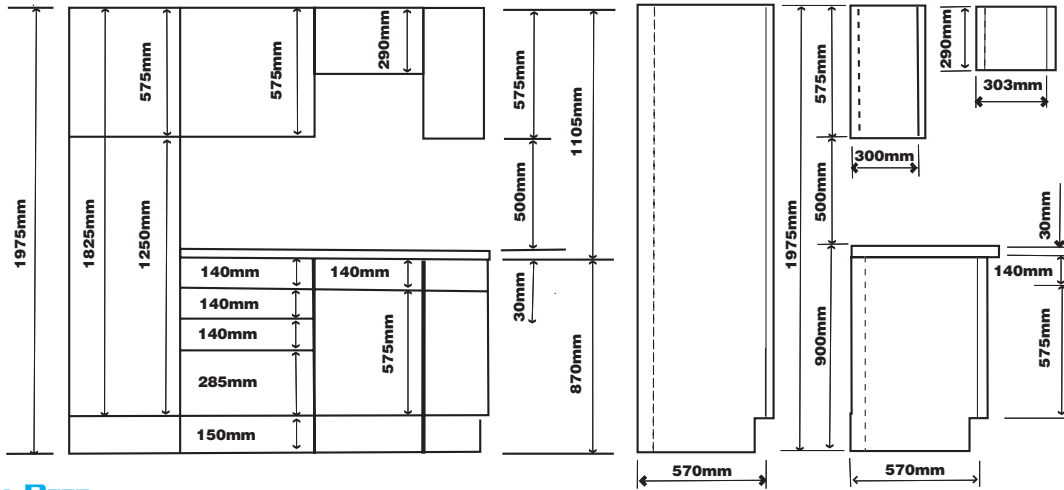

### 500MM DEEP

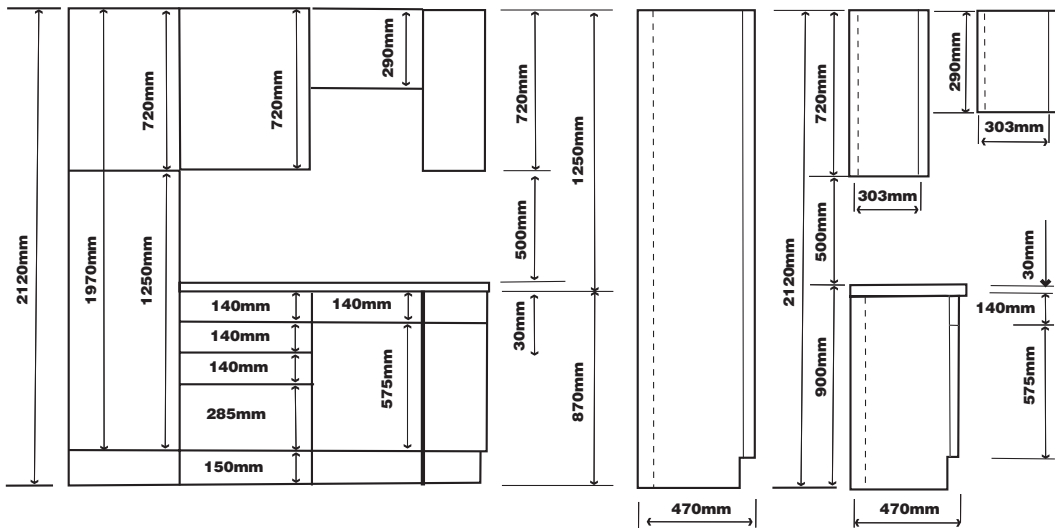

### CORNER BASE UNITS

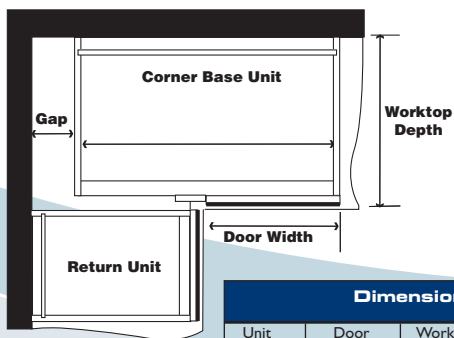

Dimensions (mm)				
Unit Width	Door Width	Worktop Depth	Gap Moorland Lakeland Highland	Gap Broadgate Country
800	300	500	30	0
800	300	600	130	100
800	400	500	130	100
800	400	600	230	200
800	500	500	230	200
800	500	600	330	300
1000	400	500	30	0
1000	400	600	30	0
1000	500	500	30	0
1000	500	600	130	100
1000	600	500	130	100
1000	600	600	230	200

### CORNER WALL UNITS

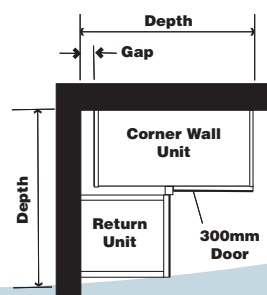

Dimensions (mm)	
Moorland/Lakeland/Highland	
Depth	Gap
630	30
Broadgate/Country	
Depth	Gap
600	0

Kitchens

Bronze + Silver Specification

### Scope Maple Range



A natural timber effect door made using modern foil wrapping technology. The simplicity of the door with its wide frame and plain panel effortlessly lends itself to any environment.

### Scope Kalvodos Range



The warm golden hue teams well with stainless steel for a superbly modern kitchen. This design shows how utilising stainless steel as a frontage can add even more to the impact of a kitchen.



## Scope Montana Range



A traditional coloured foil-wrapped door combined with a state of the art design offers many avenues for exploration in terms of design

## Opera Range



The unique design of Opera with its soft sloping corners and light beech effect foil gives a distinctive feel. A simple unadorned door, the beech grain gives life to the door making it easy to complement with accessories.



**Solway Range**



The Foil wrapped white door with its traditional profile makes this style very popular



Solway

**Other Door Options**

Two other foil-wrapped doors that we can offer are:



Carisbrooke



Providence Swiss Pear

**Handles**

On the Gold specification handles are not included in the price. The following are a selection available to complement our range of doors.



Wooden knob



Dimpled 'D' Handle



Large Chrome 'D' Handle



Bow Handle



T-bar Handle



White Ceramic knob

For any other type of handle please do not hesitate to contact us



## Specification for Gold Range

All Gold specification units are made on an 18mm ready assembled colour co-ordinated carcass internally and externally. All base units are on a box-on-legs carcass.

### CONSTRUCTION

These units are glued and dowelled with 6mm x 30mm dowels.

### CARCASS MATERIAL

- All the chipboard used is certified to the European Formaldehyde Emission Standard E1
  - All panels have been tested to BS476 Part 7, surface spread of flame and achieves class 2
  - All of the melamine faced 18mm particle board achieve BS5669 with a density of 680kg/m<sup>3</sup>
  - The panels achieve a bending strength of 220kg/m<sup>3</sup>
  - All end panels are edged on all four edges and achieve BS3962
  - The thickness of the melamine edging used is 0.30 thick and protected surfaces are tested to BS3962
  - A vertical white vinyl-wrapped centre post of 30mm x 36mm is fitted to double units. In colour co-ordinated carcasses the front is edged in a matching strip.
- The base units have a 60mm front rail. Backs are either 18mm or 12mm and 600mm high for all bases except for drawerline doubles which are 680mm, and some pull out units which are full height.

### DRAWER SYSTEM

The drawers are Blum Metabox construction which incorporates a drawer bottom and back made from 18mm particleboard. Drawer sides are enamelled steel and incorporate steel runners with nylon stops, which are self-closing from 60mm. All drawer boxes are manufactured in accordance with BS4875 (1985): Part 7 Level 4.

### HINGES

Units are supplied with Blum 170° hinges with a self closing action and allow four-way adjustment. The hinges meet the strength requirements of BS4875 (1985): Part 7 Level 4 and BS6222 Part 2 (1992) Level H. Hinge holes only occur where hinges are required so no unsightly hinge holes can be found on the carcass.

### PLINTH AND LEGS

2400mm length and 150mm high plinth supplied and cut according to requirement. Plastic adjustable legs screw into flanges at the bottom of all base units.

### FASCIAS

Doors and drawers can be adjusted for alignment purposes.

### BRACKETS

The wall hanging brackets are connected and fully adjustable. They are made from rolled steel and achieve DIN code 68840 with a loading capacity of 130kg per pair.

### HARDBOARD BACK AND VOIDS

Hardboard back is only on wall units on a white carcass. All other carcasses have 18mm colour co-ordinated backing.

500mm deep base units have 23mm void

600mm deep base units have 60mm void



















300mm deep wall units have 20mm void

### SHELVES

All shelves are manufactured from the same materials and to the same standards as the cabinet itself. The shelf is variable between three heights and is supported by a plastic coated metal peg.

## Worktops

Available in eighteen different colours, 3000mm long 30 or 40mm thick and have been carefully selected to offer the best possible choice to combine with our fascia and carcass colours.

	30MM	40MM		30MM	40MM
 <b>Adriatic Marble</b>	S3270124	S3270224	 <b>Dapple Slate</b>	S3270131	S3270231
 <b>Arran</b>	S3270120	S3270220	 <b>Moss Green</b>	S3270132	S3270232
 <b>Olympus Onyx</b>	S3270128	N/A	 <b>Chiltern Beech</b>	S3270101	N/A
 <b>Stratus Grey</b>	S3270123	S3270223	 <b>Windsor Oak</b>	S3270125	S3270225
 <b>Martian</b>	S3270005	S3270228	 <b>Autumn Sand</b>	S3270133	N/A
 <b>Rossini Granite</b>	S3270127	S3270227	 <b>Jupurana</b>	S3270134	S3270234
 <b>Pacific Blue</b>	S3270129	S3270229	 <b>Maple</b>	S3270135	S3270235
 <b>Coral Green</b>	S3270130	S3270230	 <b>Aragon</b>	S3270136	S3270236
 <b>White</b>	S3270121	S.32702.21	 <b>Stratus Beige</b>	S3270126	S3270226

## Worktop Joints Satin Finish

### CORNER

S3272001 - 30mm  
S3272003 - 40mm

### IN LINE STRIP

S3272002 - 30mm  
S3272005 - 40mm

### END STRIP

S3272011 - 30mm  
S3272004 - 40mm

## The Service

The process from turning a void area into a fully fitted kitchen is often thought to be fraught with many problems. This does not necessarily have to be the case.

N&C offer the facility of a representative surveying the kitchen. At this stage the style of kitchen will be discussed and tailored to suit your budgetary requirements.

Potential issues will be highlighted eg. pipes, radiators and any individual customer preferences. The survey will then be sent to our design department where a plan, perspective and detailed quotation will be prepared.



Once an order is placed detailing various choices of colours and handles we will confirm delivery requirements to suit your fitting schedule.

At all stages our sales team will be happy to discuss your requirements to ensure the kitchen is supplied to guarantee customer satisfaction.

## Inset - Standard Sinks

Stainless Steel-All sinks are manufactured from the highest quality 18/10 stainless steel.

### SINGLE BOWL SINGLE DRAINER 2 TAPHOLE



Dimensions 940 x 485 Bowl Dimensions 420 x 345 x 170

S3008502 - LHD Single Bowl Single Drainer 2 Tapholes  
S3008501 - RHD Single Bowl Single Drainer 2 Tapholes

### SINGLE BOWL SINGLE DRAINER 1 TAPHOLE (REVERSIBLE)



Dimensions 800 x 510 Main Bowl Dimensions 419 x 343 x 180

S3008503 - Single Bowl Single Drainer 1 Taphole

### ONE AND A HALF BOWL SINGLE DRAINER 1 TAPHOLE (REVERSIBLE)



Dimensions 965 x 510 Main Bowl Dimensions 419 x 343 x 168

S3008504 - One and a Half Bowl Single Drainer 1 Taphole  
S3008505 - Pack with Waste and Tap\*

### SINGLE BOWL DOUBLE DRAINER



Dimensions 1310 x 510 Main Bowl Dimensions 400 x 340 x 160

S3007003 - 1 Taphole  
S3007001 - 2 Tapholes

### DOUBLE BOWL SINGLE DRAINER



Dimensions 1310 x 510 Bowl Dimensions 400 x 340 x 160

S3006502 - LHD Double Bowl Single Drainer 1 Taphole  
S3006501 - RHD Double Bowl Single Drainer 1 Taphole  
S3006504 - LHD Double Bowl Single Drainer 2 Tapholes  
S3006503 - RHD Double Bowl Single Drainer 2 Tapholes

## Inset - Others

### SHALLOW DEPTH BOWL



Dimensions 940 x 490 Bowl Dimensions 400 x 340 x 127

P1800031 - 1 Taphole  
P6882011 - LHD 2 Tapholes  
P6882001 - RHD 2 Tapholes

### SUPER DEEP SINGLE BOWL SINGLE DRAINER



Dimensions 980 x 510 Bowl Dimensions 508 x 356 x 254

S3006506 - LHD 1 Taphole  
S3006505 - RHD 1 Taphole  
S3006508 - LHD 2 Tapholes  
S3006507 - RHD 2 Tapholes

### REDUCED SIZE SINGLE BOWL SINGLE DRAINER 1 TAPHOLE (REVERSIBLE)



Dimensions 860 x 435 Bowl Dimensions 360 x 335 x 150

S3006509 - Reduced Size Single Bowl Single Drainer\*  
(Contains Specialized Chrome Waste)

### REDUCED SIZE SINGLE BOWL



Dimensions 460 x 435 Bowl Dimensions 340 x 340 x 160

S3006510 - Reduced Size Single Bowl\*  
(Contains Specialized Chrome Waste)

### REDUCED SIZE DOUBLE BOWL 1 TAPHOLE (REVERSIBLE)



Dimensions 860 x 420 Bowl Dimensions 340 x 340 x 160

S3006511 - Reduced Size Double Bowl\*  
(Contains Specialized Chrome Waste)

All inset sinks require 38mm combined sink waste and overflow (chrome plated) 52361001 except items marked \*



**Sit-on Sinks (All Two Taphole)**

Sinktops

**1000 x 500 SINGLE BOWL SINGLE DRAINER**



Dimensions 1000 x 500

Square Edge

S3001522 - LHD 2 Tapholes

S3001521 - RHD 2 Tapholes

Rollfront

S3006004 - LHD 2 Tapholes

S3006003 - RHD 2 Tapholes

**1500 x 600 SINGLE BOWL DOUBLE DRAINER**



Dimensions 1500 x 600

Square Edge

S3001001 - 2 Tapholes

Rollfront

S3005501 - 2 Tapholes

**1000 x 600 SINGLE BOWL SINGLE DRAINER**



Dimensions 1000 x 600

Square Edge

S3001512 - LHD 2 Tapholes

S3001511 - RHD 2 Tapholes

Rollfront

S3006002 - LHD 2 Tapholes

S3006001 - RHD 2 Tapholes

**1500 x 500 DOUBLE BOWL SINGLE DRAINER**



Dimensions 1500 x 500

Square Edge

S3000512 - LHD 2 Tapholes

S3000511 - RHD 2 Tapholes

Rollfront

S3000514 - LHD 2 Tapholes

S3000513 - RHD 2 Tapholes

**1500 x 600 DOUBLE BOWL SINGLE DRAINER**



Dimensions 1500 x 600

Square Edge

S3000502 - LHD 2 Tapholes

S3000501 - RHD 2 Tapholes

Rollfront

S3005002 - LHD 2 Tapholes

S3005001 - RHD 2 Tapholes

**1200 x 600 SINGLE BOWL SINGLE DRAINER**



Dimensions 1200 x 600

Square Edge

S3001502 - LHD 2 Tapholes

S3001501 - RHD 2 Tapholes

Rollfront

S3001503 - LHD 2 Tapholes

S3001504 - RHD 2 Tapholes

**1500 x 500 SINGLE BOWL DOUBLE DRAINER**



Dimensions 1500 x 500

Square Edge

S3001011 - 2 Tapholes

Rollfront

S3001012 - 2 Tapholes

**2000 x 600 DOUBLE BOWL DOUBLE DRAINER**



Dimensions 2000 x 600

Square Edge

S3000001 - 2 Tapholes

Rollfront

S3000002 - 2 Tapholes

All sit-on sinks require 38mm combined sink waste and overflow (chrome plated) S2361001

## Stainless Steel Sinks

With the growth of the designer kitchen stainless steel sinks have now evolved to become a focal point in the kitchen.

### FLUTE

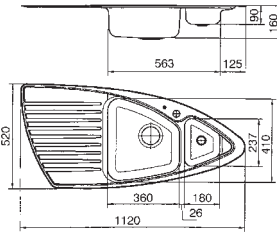

Smooth aerodynamic lines makes this one stand out from the crowd. Supplied with pop-up waste as standard

Only available in left hand drainer

**S3006552 - Polished S/Steel**

### WING

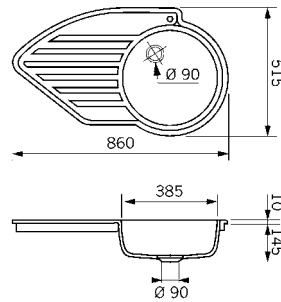

A funky alternative to the round bowl and drainer, the Wing takes the simple round bowl that step further. Supplied with pop-up waste as standard

Only available in left hand drainer

**S3006553 - Polished S/Steel**

### DUETTO

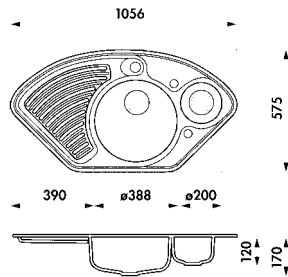

The Duetto is probably the curviest sink on the market its suitable for corner installations only. Supplied with pop-up waste as standard

**S3006554 - Polished S/Steel**

### ALTO

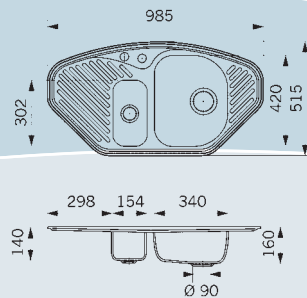

A corner sink although this one will fit into a straight run situation if desired. The Alto is supplied with pop-up chrome waste

**S3006555 - Polished S/Steel**

### ROUND BOWL AND DRAINER

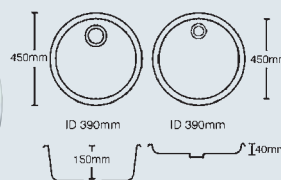

Stainless steel Bowl includes 3.5 inch diameter basket strainer waste.

**S3006556 - Polished S/Steel Bowl**

**S3006557 - Polished S/Steel Drainer**

## Ceramic Sinks

Ceramic is an ideal material for sinks. It is very attractive but also extremely tough. They are individually hand finished in fire-clay. The natural properties ensure that it can withstand extremes of hot and cold as well as chemicals and detergents commonly used in the home.

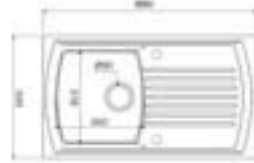

Single bowl single drainer  
1 taphole (reversible)

**S3006550** - Supplied with Basket Strainer Waste

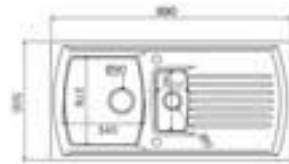

One and a half bowl single drainer  
1 taphole (reversible)

**S3006551** - Supplied with Basket Strainer Waste

## Cristalite Granite Sinks

Cristalite Granite is a significant advance in the sink market recently. It consists of 80% natural granite which means it is extremely tough with the hardness and resistance of natural stone. It is virtually impossible to scratch and can withstand all household chemicals including bleach. The nature of the material makes it highly resistant to impact and it can also withstand extreme temperatures of up to 280 degrees centigrade.



Both pictures show pop-up waste option included **S3006574**

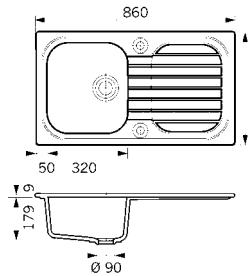

Single bowl Single drainer (SB SD)  
1 taphole (reversible) and includes basket strainer waste

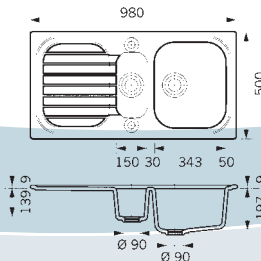

1.5 Bowl Single Drainer (1.5B SD)  
1 taphole (reversible) and includes basket strainer waste



Alpine



Marin



Montana



Lava



terra



Vanilla



Colorado



Forest

**SB SD** S3006558 S3006559 S3006560 S3006561 S3006562 S3006563 S3006564 S3006565  
**1.5B SD** S3006566 S3006567 S3006568 S3006569 S3006570 S3006571 S3006572 S3006573

## Appliances

The role of the kitchen has evolved over the years. Peoples lifestyles have changed and many people spend less time in their kitchen. Appliances are constantly being improved and upgraded to make life easier for everyone.

On the following four pages we have highlighted some of the major brands available. They are by no means a complete portfolio, but simply a flavour to show what we can offer.

## Candy White Built-in Products



S3273001 - Single Oven

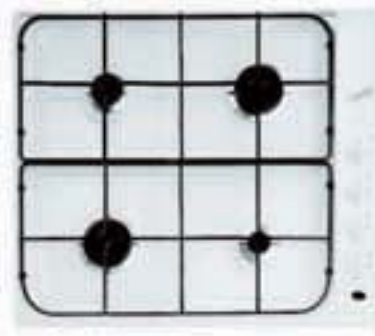

S3273040 - Gas Hob



S3273004 - Traditional White Hood

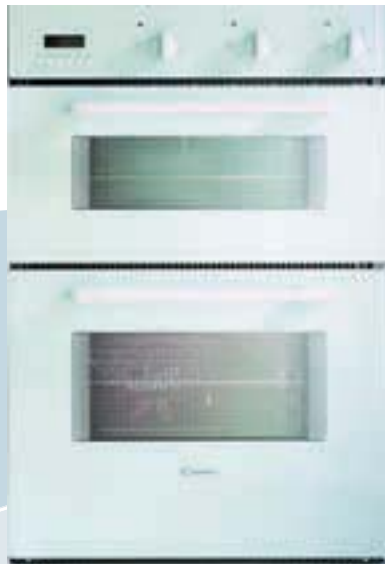

S3273041 - Double Oven



S3273042 - Electric Hob



S3273011 - Integrated White Hood

Candy offer a choice of quality built-in and freestanding products.

Here we illustrate a standard oven, hob and hood pack:

- The oven can be either single or double
  - The hob gas or electric
- The hood traditional or integrated

Please contact us for a more detailed catalogue



## Candy Upgrade Pack - Stainless Steel



S3273043 - Single Oven



S3273044 - Gas Hob



S3273009 - Traditional Hood



S3273025 - Double Oven



S3273045 - Electric Hob



S3273010 - Chimney Hood

## Other Candy Built-in Products



S3273017 - Washer/Dryer



S3273016 - Washing Machine



S3273018 - Fully integrated 600mm Wide Dishwasher



S3273020 - Fully integrated 450 slimline Dishwasher



S3273046 - Single White Gas Oven



S3273047 - Fridge Freezer



S3273012 - Under Counter Fridge



S3273048 - Under Counter Freezer



S3273049 - Microwave Stainless Steel



S3273050 - Single Stainless Steel Gas Oven

Please contact us for a more detailed catalogue

**Electrolux Group**

Featuring many popular brands covering both built-in and freestanding markets



**S3273200 - 1000 RPM Tricity Bendix Freestanding Washing Machine White AW1000W**



**S3273201 - Parkinson Cowan 850mm Range Cooker with Electric Single Oven**



**S3273202 - Electrolux 600mm Ceramic Hob in Black**



**S3273203 - Waste Disposal Unit**



**S3273204 - 600mm Zanussi ZGC7701X Gas Cooker with Separate Oven and Grill in Stainless Steel**



**S3273205 - Zanussi ZHC613X 600mm Stainless Steel Chimney Hood**



**S3273206 - Zanussi 50/50 Built-in Fridge/Freezer ZI918-12t**



**S3273207 - Zanussi Coffee Machine Stainless Steel with S3273208 - Accessory Drawer for Coffee Machine**



**S3273209 - AEG Freestanding Chest Freezer 1325 Wide A26864**



**S3273210 - AEG Fan operated Double Electric Oven CD21601G in Green**



**S3273211 - AEG 4 Zone induction Hob**



**S3273212 - Semi Intergrated AEG F406601M Stainless Steel Dishwasher**

Please contact us for a more detailed catalogue

## Rosières - Exclusive Brand of Built-in Appliances



**S3273100** - Range Cooker 1000mm Wide  
**S3273104** - 1000mm Splashback



**S3273101** - Bocuse Cooker 1200mm Wide  
**S3273105** - 1200mm Splashback



**S3273102** - Stainless Steel Frost Free Fridge Freezer 910mm Wide



**S3273103** - Island Cooker Hood 1000mm Wide 700mm Deep

## Baumatic - Competitively Priced Appliances



**S3273400** - 900mm "Alien" 4 Burner Gas Hob



**S3273401** - 900mm Twin Cooking Theatre



**S3273402** - 900mm Curved Chimney Hood



**S3273403** - Freestanding Fridge/Freezer 660mm Wide

## Neff - Renowned Brand Leader



**S3273300** - 900mm Chimney Extractor



**S3273301** - Steam Oven



**S3273302** - Induction Hob



**S3273303** - Fully intergrated Tumble Dryer

Please contact us for a more detailed catalogue

## Mini Kitchens

In many situations space or lack of it is a pressing issue. A mini - kitchen offers a modern approach to solving this problem. We have highlighted a few popular models.

### Cooking Stations

Stainless steel sinktop with two built-in hotplates, refrigeration and either a white or stainless steel base unit



Finish: White



Finish: Stainless Steel

- S3270300 - Width 600mm LH Hotplate
- S3270301 - Width 600mm RH Hotplate
- S3270302 - Width 1000mm LH Hotplate
- S3270303 - Width 1000mm RH Hotplate
- S3270304 - Width 1200mm LH Hotplate
- S3270305 - Width 1200mm RH Hotplate
- S3270306 - Width 1500mm LH Hotplate
- S3270307 - Width 1500mm RH Hotplate

- S3270310 - Width 600mm LH Hotplate
- S3270311 - Width 600mm RH Hotplate
- S3270312 - Width 1000mm LH Hotplate
- S3270313 - Width 1000mm RH Hotplate
- S3270314 - Width 1200mm LH Hotplate
- S3270315 - Width 1200mm RH Hotplate
- S3270316 - Width 1500mm LH Hotplate
- S3270317 - Width 1500mm RH Hotplate

Height 890 Depth 600  
Handings dependent on position of hotplate.

### Tea Stations

Tea Station with stainless steel sinktop, refridgerator and either white or steel base unit.  
NB. Units do not include taps



Finish: White



Finish: Stainless Steel

- S3270320 - Width 600mm LH Drainer
- S3270321 - Width 600mm RH Drainer
- S3270322 - Width 1000mm LH Drainer
- S3270323 - Width 1000mm RH Drainer
- S3270324 - Width 1200mm LH Drainer
- S3270325 - Width 1200mm RH Drainer
- S3270326 - Width 1500mm LH Drainer
- S3270327 - Width 1500mm RH Drainer

- S3270330 - Width 600mm LH Drainer
- S3270331 - Width 600mm RH Drainer
- S3270332 - Width 1000mm LH Drainer
- S3270333 - Width 1000mm RH Drainer
- S3270334 - Width 1200mm LH Drainer
- S3270335 - Width 1200mm RH Drainer
- S3270336 - Width 1500mm LH Drainer
- S3270337 - Width 1500mm RH Drainer

Height 890 Depth 600  
Handings dependent on position of drainer.



## Mini Kitchens

### Shuttaway Kitchen



- Stainless Steel Sinktop with two built in hotplates
- Refrigeration
- Microwave with grill
- Monobloc Tap
- Cupboard and Drawer
- Shelving and laminate backboard
- Complete with Tamdour Shutter
- Lockable

S3270338 - LH Hotplate

S3270339 - RH Hotplate

Height 1950mm Depth 700mm Width 1250

### Sit-on Sinks with Hotplates



S3270340 - Width 1000mm LH Hotplate

S3270341 - Width 1000mm RH Hotplate



S3270342 - Width 1200mm LH Hotplate

S3270343 - Width 1200mm RH Hotplate



S3270344 - Width 1500mm LH Hotplate

S3270345 - Width 1500mm RH Hotplate

Handing refers to side of the hotplate  
Please do not forget to specify taps

Mini Kitchens

## Halogen Spotlighting for Recessed Mounting

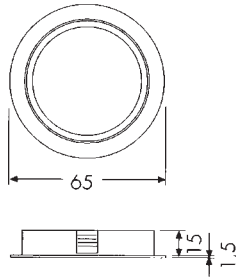

- S3004000 - 2 Light Set Brass
- S3004001 - 3 Light Set Brass
- S3004002 - 2 Light Set Stainless Steel
- S3004003 - 3 Light Set Stainless Steel
- S3004004 - 2 Light Set White
- S3004005 - 3 Light Set white

## Triangular Halogen Spotlight

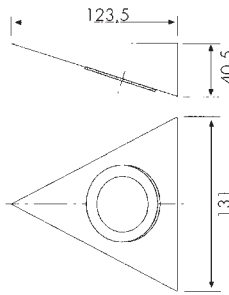

- S3004006 - 2 Light Set Brass
- S3004007 - 3 Light Set Brass

Only available in Brass

## Round Halogen Spotlight

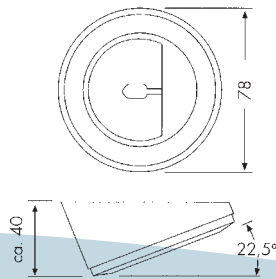
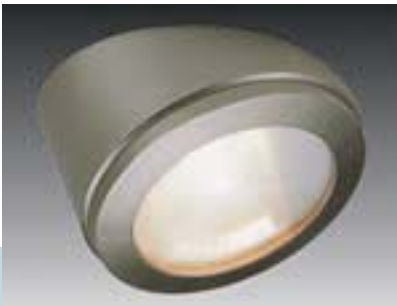

- S3004008 - 2 Light Set Stainless Steel
- S3004009 - 3 Light Set Stainless Steel
- S3004010 - 5 Light Set Stainless Steel

Only available in Stainless Steel

## Arc Light Set

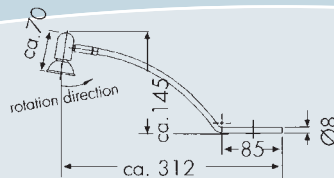

- S3004011 - 2 Light Set Stainless Steel
- S3004012 - 3 Light Set Stainless Steel

Only available in Stainless Steel

### OPTIONS

- S3004013 - EBS Touch Control Version for use with Triangular Halogen Spotlights
- S3004014 - EBS Sensor and Sensor Switch for other Halogen Lights
- S3004015 - Replacement Bulb for Halogen Lights
- S3004016 - Replacement Bulb for Halogen with Lens
- S3004017 - Transformer for use with 2+3 Light Sets
- S3004018 - Transformer for use with 5 Light Sets

## Accessories

### CUTLERY TRAY



Available in grey plastic to suit cabinet width

S3004100 - 400mm  
S3004101 - 500mm  
S3004102 - 600mm

### DECORATIVE LEG



Silver lacquered plastic conical shape furniture leg

S3004108 - Silver

### ROUND WASTE BIN



15 Litre Waste Bin, The lid automatically tilts when the door is opened. Cabinet width 400mm

S3004104 - Stainless Steel  
S3004103 - White

### POLE STORAGE SYSTEM



Accessories held in place with a locking ring. Pole height 1825 or 3020mm and can be cut to suit. Accessories include:

- Glass Holder
- Round Basket
- Glass Shelf
- Chrome Shelf
- Swing Arm

S3004109 - 1825mm (inc 5 Accessories)  
S3004110 - 3020mm (inc 5 Accessories)

### ALUMINIUM TOWEL RAIL



Top or side mounted 465 long.

S3004114 - 2 Rails 93mm  
S3004105 - 3 Rails 138mm

### STAINLESS STEEL PILASTER



For use between or at the end of a run of base units. 50mm wide 870mm high

S3004111 - Stainless Steel

### CHROME BREAKFAST BAR LEG



For use with tables, worktops or breakfast bars Height 870mm diameter 60mm

S3004106 - Chrome

### CONNECTING PLATE

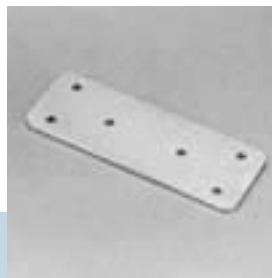

Steel joining plate used to connect 2 doors or a door and drawer together

S3004112 - White

### BOTTLE RACK



S3004107 - Chrome

### CHROME STORAGE BASKET



For use in hinged door cabinets and slides on ball-bearing runners. Heavy gauge chrome-plated steel wire

S3004113 - Chrome



For more information go to [www.barbourproductsearch.info](http://www.barbourproductsearch.info)

## Classical Cast Iron Rainwater & Gutter Systems

Traditional cast iron rainwater and gutter systems to BS460



# Cast iron. Costing less...

# ...delivering more

## Timesaver Drainage Systems



Complete cast iron drainage systems for above and below ground to BS 416 and BS 437

## Ensign Drainage Systems



Complete cast iron drainage systems for above and below ground to BS EN 877

Saint-Gobain Pipelines provides solutions through technical excellence, innovation, service and technology for the building industry.

*As well as specialising in the manufacture of cast iron rainwater and gutter systems, Saint-Gobain Pipelines Soil & Drain is the leading producer of cast iron above and below ground drainage systems .*

*Specification of Classical, Ensign and Timesaver is easy - with detailed technical information on the Saint-Gobain Pipelines Soil & Drain website, along with installation advice and stockist details. Visit: [www.saint-gobain-pipelines.co.uk](http://www.saint-gobain-pipelines.co.uk) (Click on 'Soil and Drain')*



# N&C

## Building Materials



# Castings

At N&C our casting division has always been unique when compared to other builders merchants. Not just because of the fact that the majority of the products contained within this section are held in stock available for next day delivery. Unique also because of the wealth of technical knowledge on castings and related products gained over the years by our experienced sales team.

Should you require Rainwater Pipes and Gutters, Soil and Drain Pipe in cast iron or Plastic, Manhole Covers and Frames, Gratings and frames, Sash Weights in lead or cast iron or indeed Gulleys and Traps  
**THINK N&C BUILDING MATERIALS**

## Manhole Covers and Frames Cast Iron

### PATTERN BX1



Cast Iron standard pattern, single seal. Clear opening sizes given Pedestrian Duty

- C3000002**  
Size: 305 x 305mm  
Weight: 13kg
- C3000003**  
Size: 380 x 380mm  
Weight: 16kg
- C3000004**  
Size: 455 x 305mm  
Weight: 18kg
- C3000005**  
Size: 455 x 455mm  
Weight: 25kg
- C3000006**  
Size: 455 x 455mm  
Weight: 38kg
- C3000008**  
Size: 610 x 455mm  
Weight: 25kg
- C3000009**  
Size: 610 x 455mm  
Weight: 38kg
- C3000010**  
Size: 610 x 455mm  
Weight: 51kg
- C3000013**  
Size: 610 x 610mm  
Weight: 51kg
- C3000014**  
Size: 610 x 610mm  
Weight: 102kg
- C3000016**  
Size: 760 x 610mm  
Weight: 102kg
- C3000017**  
Size: 760 x 760mm  
Weight: 108kg
- C3000018**  
Size: 915 x 610mm  
Weight: 117kg

### PATTERN BX2

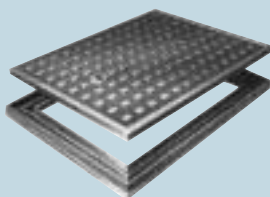

Grey iron Double seal, single cover Clear opening sizes given

- C3000501**  
Size: 305 x 305mm  
Weight: 25.5kg
- C3000502**  
Size: 455 x 455mm  
Weight: 41.5kg
- C3000503**  
Size: 610 x 455mm  
Weight: 45.5kg
- C3000505**  
Size: 610 x 610mm  
Weight: 51kg
- C3000506**  
Size: 760 x 610mm  
Weight: 69kg
- C3000507**  
Size: 915 x 610mm  
Weight: 86kg

### PATTERN BX6

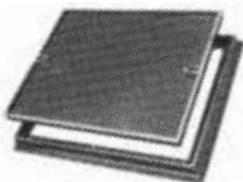

Grey iron single seal, single cover. Recessed 25mm depth Coated finish Clear opening sizes given

- C3001501**  
Size: 305 x 305mm  
Weight: 19.5kg
- C3001502**  
Size: 460 x 460mm  
Weight: 41.5kg
- C3001503**  
Size: 610 x 460mm  
Weight: 52.5kg
- C3001504**  
Size: 610 x 610mm  
Weight: 82.5kg
- C3001505**  
Size: 760 x 610mm  
Weight: 90kg

### PATTERN BX7



Grey iron single seal, single cover. As pattern BX6 Recessed 56mm depth Coated finish Clear opening sizes given

- C3002001**  
Size: 610 x 455mm  
Weight: 87.5g
- C3002002**  
Size: 610 x 610mm  
Weight: 102kg
- C3002003**  
Size: 760 x 610mm  
Weight: 119kg

### PATTERN BX9

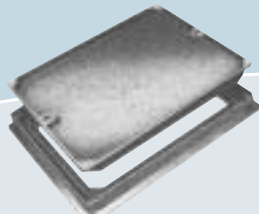

Grey iron double seal, single cover. Recessed 35mm depth Clear opening sizes given

- C3002501**  
Size: 460 x 460mm  
Weight: 53kg
- C3002502**  
Size: 610 x 460mm  
Weight: 59.5kg
- C3002503**  
Size: 610 x 610mm  
Weight: 80kg
- C3002504**  
Size: 760 x 610mm  
Weight: 84.5kg
- C3002505**  
Size: 915 x 610mm  
Weight: 102kg

### PATTERN BX10

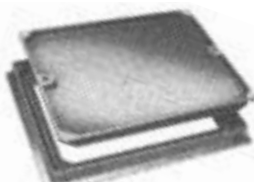

Grey iron double seal, single cover. As pattern BX9. Recessed 50mm depth Clear opening sizes given

- C3003001**  
Size: 610 x 460mm  
Weight: 89kg
- C3003002**  
Size: 610 x 610mm  
Weight: 106kg
- C3003003**  
Size: 760 x 610mm  
Weight: 122kg

### PATTERN BX12



Grey iron hinged and locking single seal, single cover Coated finish Clear opening sizes given

- C3004503**  
Size: 460 x 460mm  
Weight: 38kg
- C3004504**  
Size: 610 x 460mm  
Weight: 41.5kg
- C3004505**  
Size: 610 x 610mm  
Weight: 69.5kg
- C3004506**  
Size: 760 x 610mm  
Weight: 89kg
- C3004507**  
Size: 915 x 610mm  
Weight: 97kg

### PATTERN BX13

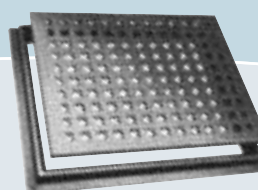

Grey iron Open mesh grating and frame 25mm mesh, 19mm thick Coated finish Clear opening sizes givens

- C3005501**  
Size: 460 x 460mm  
Weight: 46.5kg
- C3005502**  
Size: 610 x 460mm  
Weight: 54kg
- C3005503**  
Size: 610 x 610mm  
Weight: 71kg
- C3005504**  
Size: 760 x 610mm  
Weight: 83kg

### PATTERN BX16

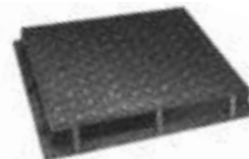

Ductile iron road type Single seal C250 loading. Coated finish Clear opening sizes given

- C3006001**  
Size: 450 x 450mm  
Weight: 55kg
- C3006002**  
Size: 600 x 450mm  
Weight: 65kg
- C3006004**  
Size: 600 x 600mm  
Weight: 75kg
- C3006006**  
Size: 750 x 600mm  
Weight: 94kg

### PATTERN BX21



Cast iron C250 loading road type, recessed. Single seal Coated finish Clear opening sizes given

- C3007501**  
Size: 610 x 455mm  
Weight: 165kg
- C3007502**  
Size: 610 x 610mm  
Weight: 232kg
- C3007503**  
Size: 760 x 610mm  
Weight: 245kg
- C3007504**  
Size: 915 x 610mm  
Weight: 254kg

### PATTERN BX23

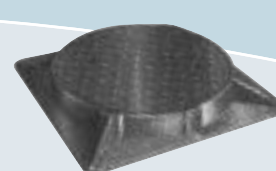

Cast iron circular road type, Solid iron cover, plain seat Square base Coated finish Clear opening sizes given

- C3009001**  
Size: 510mm Diameter  
Weight: 178kg
- C3009002**  
Size: 560mm Diameter  
Weight: 254kg
- C3009003**  
Size: 685mm Diameter  
Weight: 305kg



**Manhole Covers and Frames Cast Iron**

**PATTERN BX31**



Cast iron  
Table 1 Grade A, BS 497/67  
Heavy duty double triangular cover  
Coated finish  
Clear opening sizes given

**C3009501**  
MA50 Diameter 510mm  
Weight: 228kg  
**C3009502**  
MA55 Diameter 560mm  
Weight: 254kg  
**C3009503**  
MA60 610 x 600mm  
Weight: 305kg

Grade B, Medium duty  
**C3009511**  
MB155 Diameter 560mm  
Weight: 140kg  
**C3009512**  
MB160 600 X 600mm  
Weight: 150kg

**PATTERN BX33**



Cast iron B5EN124 Class 250  
Medium duty, circular cover  
Coated finish  
Clear opening sizes given

**C3020501**  
Diameter 510mm  
Weight: 114kg  
**C3020502**  
Diameter 560mm  
Weight: 126kg  
**C3020503**  
Diameter 610mm  
Weight: 152kg

**PATTERN BX34**

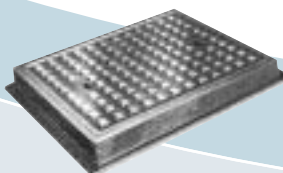

Ductile iron B5EN124 Class B125. Medium duty, solid cover.  
Coated finish  
Clear opening sizes given

**C3021001**  
Size: 600 x 450mm  
Weight: 38kg  
**C3021002**  
Size: 600 x 600mm  
Weight: 47kg

**PATTERN BX35**



Cast iron B5EN 124 Class B125  
Medium duty single seal  
Coated finish  
Clear opening sizes given

**C3021501**  
Size: 600 x 450mm  
Weight: 136kg  
**C3021502**  
Size: 600 x 600mm  
Weight: 152kg

**PATTERN BX36**

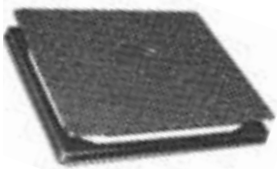

Cast iron B5EN124-A15  
Single seal  
Light duty, solid iron cover  
Coated finish  
Clear opening sizes given

**C3022001**  
Size: 450 x 450mm  
Weight: 31kg  
**C3022002**  
Size: 600 x 450mm  
Weight: 37kg  
**C3022003**  
Size: 600 x 600mm  
Weight: 59kg

**PATTERN BX37**

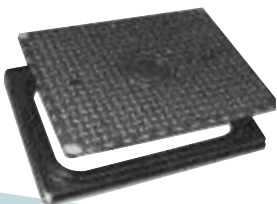

Cast iron B5EN124-A15  
double seal  
Light duty, solid iron cover  
Coated finish  
Clear opening sizes given

**C3022501**  
Size: 450 x 450mm  
Weight: 44kg  
**C3022502**  
Size: 600 x 450mm  
Weight: 51kg  
**C3022503**  
Size: 600 x 600mm  
Weight: 78kg

**PATTERN BX38**

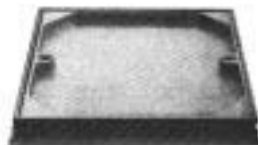

Cast iron  
B5EN 124 Class A15  
Single seal recessed 35mm depth. Light duty  
Coated finish  
Clear opening sizes given

**C3023001**  
Size: 450 x 450mm  
Weight: 38kg  
**C3023002**  
Size: 600 x 450mm  
Weight: 51kg  
**C3023003**  
Size: 600 x 600mm  
Weight: 70kg

**PATTERN BX39**

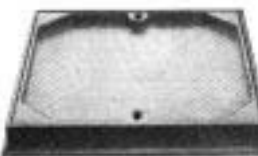

Cast iron B5EN124 Class A15  
Light duty recessed  
35mm depth. Double seal  
Coated finish  
Clear opening sizes given

**C3023501**  
Size: 450 x 450mm  
Weight: 57kg  
**C3023502**  
Size: 600 x 450mm  
Weight: 83kg  
**C3023503**  
Size: 600 x 600mm  
Weight: 108kg

**PATTERN BX211**



Ductile iron  
Medium duty B125. For secondary roads and areas subject to occasional slow moving traffic. Single piece circular opening.  
Coated finish  
Clear opening sizes given

**C3025502**  
Size:  
Diameter 600mm  
Base size:  
750 x 750 x 75mm  
Weight: 44kg

**PATTERN BX210**



Ductile iron Heavy duty  
B5EN124 Class D400 Suitable for city roads where larger access openings are Required. Double triangular, non rock  
Coated finish  
Clear opening sizes given

**C3025001**  
Size: 750 x 600mm  
Base size:  
910 x 760 x 100mm  
Weight: 136kg  
**C3025002**  
Size: 900 x 600mm  
Base size:  
1080 x 780 x 100mm  
Weight: 198kg  
**C3025003**  
Size: 900 x 900mm  
Base size:  
1060 x 1060 x 100mm  
Weight: 245kg  
**C3025005**  
Size: 1220 x 675mm  
Base size:  
1400 x 800 x 100mm  
Weight: 250kg

**PATTERN BX212**

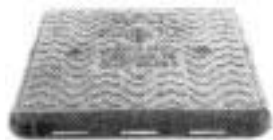

Medium duty B125 For occasional access by vehicles where non-rocking feature is not required. Single seal, single cover  
Coated finish  
Clear opening sizes given

**C3026001**  
Size: 600 x 450mm  
Base size:  
750 x 600 x 75mm  
Weight: 34kg  
**C3026002**  
Size: 600 x 600mm  
Base size:  
710 x 710 x 75mm  
Weight: 40kg

**Manhole Covers & Frames**

## Manhole Covers and Frames Steel

### PATTERN BX213

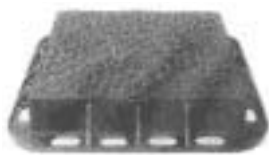

Ductile iron Heavy duty D400  
Double triangular, non rock  
For main roads carrying  
continuous heavy traffic  
Coated finish  
Clear opening sizes given

**C3026502**  
Size: 600 x 600mm  
Base Size:  
780 x 780 x 100mm  
Weight: 76kg

**C3026503**  
Size: 675 x 675mm  
Base Size:  
830 x 830 x 100mm  
Weight: 109kg

### PATTERN BX27



Single seal, single cover  
Steel frame. Coated finish  
Clear opening sizes given  
Base sizes: plus 60mm each  
way Depth 35mm

**LIGHT WEIGHT**  
5 ton laden vehicle  
(5.08 tonnes)

**C3040001**  
Size: 305 x 305mm  
**C3040002**  
Size: 380 x 380mm  
**C3040003**  
Size: 455 x 305mm  
**C3040004**  
Size: 455 x 455mm  
**C3040005**  
Size: 535 x 535mm  
**C3040006**  
Size: 610 x 455mm  
**C3040007**  
Size: 610 x 610mm  
**C3040008**  
Size: 685 x 535mm  
**C3040009**  
Size: 760 x 455mm  
**C3040010**  
Size: 760 x 610mm

**MEDIUM WEIGHT**  
10 ton laden vehicles  
(10.16 tonnes)

**C3040504**  
Size: 455 x 455mm  
**C3040505**  
Size: 535 x 535mm  
**C3040506**  
Size: 610 x 455mm  
**C3040507**  
Size: 610 x 610mm  
**C3040508**  
Size: 685 x 535mm  
**C3040509**  
Size: 760 x 455mm  
**C3040510**  
Size: 760 x 610mm  
**C3040511**  
Size: 760 x 760mm

**HEAVY WEIGHT**  
15 ton laden vehicle  
(15.23 tonnes)

**C3041004**  
Size: 455 x 455mm  
**C3041005**  
Size: 535 x 535mm  
**C3041006**  
Size: 610 x 455mm  
**C3041007**  
Size: 610 x 610mm  
**C3041008**  
Size: 685 x 535mm  
**C3041009**  
Size: 760 x 455mm  
**C3041010**  
Size: 760 x 610mm  
**C3041011**  
Size: 760 x 760mm  
**C3041012**  
Size: 915 x 610mm  
**C3041013**  
Size: 915 x 760mm  
**C3041014**  
Size: 915 x 915mm

### PATTERN BX28

Double seal, single cover  
Steel frame.  
Coated finish  
Clear opening sizes given  
Base sizes: plus 90mm each  
way Depth 37mm

**LIGHT WEIGHT**  
5 ton laden vehicle  
(5.08 tonnes)

**C3042001**  
Size: 305 x 305mm  
**C3042002**  
Size: 380 x 380mm  
**C3042003**  
Size: 455 x 455mm  
**C3042004**  
Size: 535 x 535mm  
**C3042005**  
Size: 610 x 455mm  
**C3042006**  
Size: 610 x 610mm  
**C3042007**  
Size: 685 x 535mm  
**C3042008**  
Size: 760 x 455mm  
**C3042009**  
Size: 760 x 610mm

**MEDIUM WEIGHT**  
10 ton laden vehicle  
(10.16 tonnes)

**C3042501**  
Size: 305 x 305mm  
**C3042502**  
Size: 380 x 380mm  
**C3042503**  
Size: 455 x 455mm  
**C3042504**  
Size: 535 x 535mm  
**C3042505**  
Size: 610 x 455mm  
**C3042506**  
Size: 610 x 610mm  
**C3042507**  
Size: 685 x 535mm  
**C3042508**  
Size: 760 x 455mm  
**C3042509**  
Size: 760 x 610mm  
**C3042510**  
Size: 760 x 760mm  
**C3042511**  
Size: 915 x 610mm  
**C3042512**  
Size: 915 x 760mm  
**C3042513**  
Size: 915 x 915mm

**HEAVY WEIGHT**  
15 ton laden vehicle  
(15.24 tonnes)

**C3043003**  
Size: 455 x 455mm  
**C3043004**  
Size: 535 x 535mm  
**C3043005**  
Size: 610 x 455mm  
**C3043006**  
Size: 610 x 610mm  
**C3043007**  
Size: 685 x 535mm  
**C3043008**  
Size: 760 x 455mm  
**C3043009**  
Size: 760 x 610mm  
**C3043010**  
Size: 760 x 760mm  
**C3043011**  
Size: 915 x 610mm  
**C3043012**  
Size: 915 x 760mm  
**C3043013**  
Size: 915 x 915mm

### PATTERN BX29

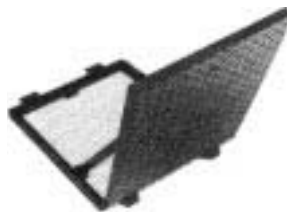

Hinged and locking  
Unbreakable steel. Single  
seal, steel frame  
Locking and lift key included  
Coated finish  
Clear opening sizes given  
Base size: plus 60mm each  
way

**LIGHT WEIGHT**

**C3045001**  
Size: 305 x 305mm  
**C3045004**  
Size: 455 x 455mm  
**C3045005**  
Size: 610 x 455mm  
**C3045006**  
Size: 610 x 610mm  
**C3045008**  
Size: 760 x 610mm

### PATTERN BX110

**TO ORDER ONLY**

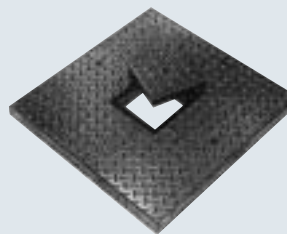

Peephole pattern  
Unbreakable steel  
Single seal, single cover  
Steel frame. For use over fuel  
tanks and Valves etc.  
Peephole size: 150 x 150mm  
Separate keyhole facilitates  
easy removal

## COLOURED COVERS PEDESTRIAN DUTY

Coloured Covers provide a 5  
minute solution to improving  
a garden eyesore - The ugly  
Access cover, stuck in the  
middle of the lawn or patio.  
They will fit the majority of  
inspection chambers used in  
domestic areas, without the  
need to replace the existing  
frame thus eliminating  
unnecessary groundwork.

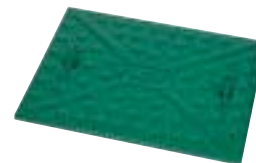

**Standard Colours**  
Available Are:

**C3079601**  
Ascot Green  
Size: 600 x 450mm  
2.5 Tonne  
**C3079602**  
Brighton Brindle  
Size: 600 x 450mm  
2.5 Tonne  
**C3079603**  
York Yellow  
Size: 600 x 450mm  
2.5 Tonne  
**C3079604**  
Chelsea Blue  
Size: 600 x 450mm  
2.5 Tonne  
**C3079605**  
Kensington Black  
Size: 600 x 450mm  
2.5 Tonne



**Manhole Covers and Frames Steel**

**PATTERN BX107**



Triple covers, hinged and locking  
Single seal  
Lock and lift key included  
Key is immovable until cover is Locked  
Coated finish  
**TO ORDER ONLY**

**PATTERN BX108**

Triple covers, drop in type Single seal  
Steel frame  
Not hinged and locking  
Coated finish  
**TO ORDER ONLY**

**PATTERN BX221  
PURPOSE MADE  
ACCESS COVERS**



Unbreakable steel for all loadings and any size. These covers can be adapted to suit any particular site requirement incorporating many refinements. Can be designed for specific requirements in pumping stations, factories etc.  
Full details on application  
**TO ORDER ONLY**

**PATTERN BX109**

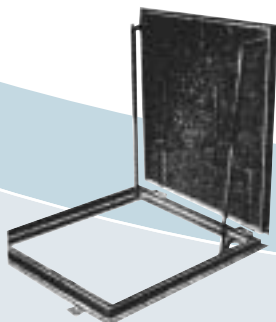

Assisted lift, hinged and locking unbreakable steel  
Single seal, steel frame  
Quick and effortless opening from below or above  
Coated finish  
**TO ORDER ONLY**

**PATTERN BX130**



Twin covers, hinged and locking single seal, Unbreakable steel frame  
Lifting key included  
**TO ORDER ONLY**

**PATTERN BX106**

Twin covers, drop-in type single seal, single frame  
Not hinged and locking  
Coated finish  
**TO ORDER ONLY**

**RECESSED BLOCK PAVIOR  
INFILL ACCESS COVER  
AND FRAME**



Designed specifically for domestic driveway/patio use where an aesthetically pleasing design is paramount. Recessed lid to accept block paving or slab infill. Solid base plate design. Angled inner frame to aid lid removal. Robust lifting eyes pierced to accept standard profile lifting keys. Fully flanged frame. Single seal assembly.  
Recess Size 100mm deep

5 tonne G.L.V.W.

C3074001 - Size 450 x 450mm  
C3074002 - Size 600 x 450mm  
C3074003 - Size 600 x 600mm

10 tonne G.L.V.W.

C3074004 - Size 600 x 450mm  
C3074005 - Size 600 x 600mm

(Other depths are available to order)

**Manhole Accessories**



**PATTERN BX220  
LIFTING TOOL**

Ductile iron light and easily carried  
Incorporating wheel with four different key heads to suit most keyholes (Sold singly, not in pairs)  
Painted finish

C3060001 - BX220 Lifting Tool

**PATTERN BX71 LIFTING  
KEYS**

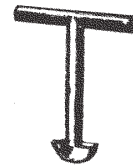

C3060501 - Light Pattern  
C3060502 - Heavy Pattern

**MANHOLE GREASE**



C3061501 - 500 Gram  
For Sealing Covers

**PATTERN BX70 STEP IRON**

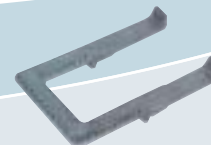

Malleable to B5.1247/55  
Galvanised finish  
For building into brickwork  
Brickwork sizes given

C3061001 - Size: 114mm  
Weight: 1.6kg

C3061002 - Size: 228mm  
Weight: 2.1kg

## Recessed Covers

### TRAY TYPE COVERS AND FRAMES

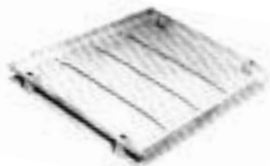

Double seal  
Zinc coated finish  
Medium - for a 5 ton laden vehicle  
Double rubber seal drop in with 4 screws

**C3075501**  
Size: 305 x 305mm

**C3076004**  
Size: 455 x 455mm

**C3076504**  
Size: 610 x 455mm

**C3077004**  
Size: 610 x 610mm

**C3077503**  
Size: 760 x 610mm

**C3078503**  
Size: 915 x 610mm

**C3079003**  
Size: 915 x 915mm

**BRASS EDGING AVAILABLE TO ORDER**

### PAIR LIFTING KEYS

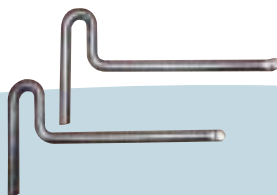

**C3079005** - Lifting Keys

### PATTERN BX202

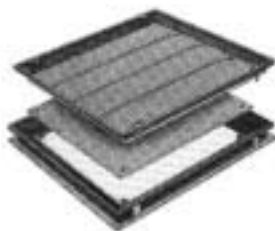

All steel double seal, double cover. Finish: zinc plated  
Designed for installation in basement floors of hospitals, super markets, shops, public buildings etc. where an air tight seal is required. Outer cover recessed 40mm to receive most flooring finishes. Secured by 4 brass screws  
Inner cover fitted with a durable rubber seal and secured by 4 brass screws  
Clear opening sizes given  
With plain edges:

**C3079501**  
Size: 450 x 450mm

**C3079502**  
Size: 600 x 450mm

**C3079503**  
Size: 600 x 600mm

**C3079504**  
Size: 750 x 600mm

**C3079505**  
Size: 750 x 750mm

**C3079506**  
Size: 900 x 600mm

**C3079507**  
Size: 900 x 750mm

**BRASS EDGING AVAILABLE TO ORDER**

### GRATING & FRAME PATTERN BX223

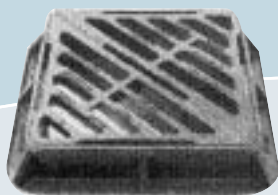

Ductile iron D400  
Double triangular, non-rock  
Large waterway area  
Coated finish  
Clear opening sizes given

**C3087001**  
Size: 435 x 435mm  
Base size: 585 x 525 x 100mm  
Weight: 46kg

## Gully Gratings

### PATTERN BX225



Ductile iron Class C250  
Single piece grating  
Can be hinged right or left to suit traffic flow  
Anti-theft captive hinge  
Coated finish  
Clear opening sizes given

**C3088001**  
370 x 320 x 100mm  
Base Size: 525 x 400mm  
Weight: 28kg  
Hinged Right Hand

**C3088002**  
Hinged Left Hand

**C3088021**  
510 x 360 x 100mm  
Base Size: 660 x 450mm  
Weight: 42kg  
Hinged Right Hand

**C3088022**  
Hinged Left Hand

**C3088031**  
375 x 430 x 100mm  
Base size: 525 x 525mm  
Weight: 37kg  
Hinged Right Hand

**C3088032**  
Hinged Left Hand

### PATTERN BX226

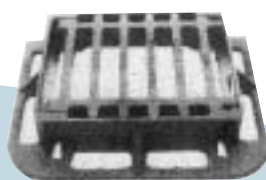

Ductile iron Class C250  
Single piece grating  
Can be hinged to right or left to suit traffic flow  
Anti-theft captive hinge  
Coated finish  
Clear opening sizes given

**C3088501**  
360 x 320 x 75mm  
Base Size: 510 x 400mm  
Weight: 22kg  
Hinged Right Hand

**C3088502**  
Hinged Left Hand

**C3088511**  
510 x 430 x 75mm  
Base Size: 650 x 430mm  
Weight: 35kg  
Hinged Right Hand

**C3088512**  
Hinged Left Hand

### PATTERN BX44



Cast iron  
Standard pattern dished top  
Overall top sizes given  
Coated finish

**C3082001**  
Size: 215 x 215mm  
Weight: 28kg

**C3082002**  
Size: 305 x 280mm  
Weight: 64kg

**C3082003**  
Size: 305 x 305mm  
Weight: 30kg

**C3082004**  
Size: 345 x 345mm  
Weight: 80kg

**C3082005**  
Size: 405 x 355mm  
Weight: 76kg

**C3082006**  
Size: 405 x 355mm  
Weight: 92kg

**C3082007**  
Size: 510 x 355mm  
Weight: 140kg

### PATTERN BX40

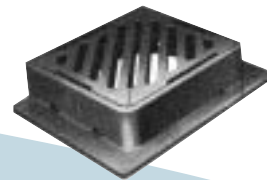

Gully grating heavy duty  
Cast iron. Table 10 Grade A, B5497/67 Double triangular  
Three point suspension, non rocking. For use in carriage ways and Capable of bearing wheel loads up to 11.43 tonnes  
Designed in two triangular sections, loosely bolted together  
Depth: 150mm  
Coated finish

**C3080001**  
GA1/450  
Grating size: 500 x 450mm  
Base Size: 710 x 560mm  
Weight: 152.4kg

**C3080002**  
GA1/450  
Grating Size: 475 x 475mm  
Base Size: 620 x 570mm  
Weight: 102kg

**Gully Gratings**

**PATTERN BX41**



Straight bar, medium duty  
Cast iron. Table 12 Grade B,  
BS.49767 Flat top, lift out  
Flanged on three sides  
For level roads and gradients  
under 1 in 50  
For roads carrying normal  
commercial vehicles 14.22  
tonnes gross weight  
Depth: 150mm  
Coated finish

**C3080501**  
GB325 Grating Size:  
400 x 350mm  
Base Size: 585 x 475mm  
Weight: 101.6kg

**C3080502**  
Non-BSS Grating size:  
500 x 350mm  
Base Size: 710 x 500mm  
Weight: 139.7kg

**PATTERN BX42**

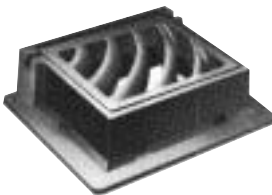

Cast iron curved bar,  
medium duty Table 13 Grade  
B, BS.497/67  
Flat top, lift out Flanged on  
three sides. For roads  
carrying normal  
Commercial vehicles 14.22  
tonnes gross weight

**OPTIONS:**  
Can be supplied with bars on  
a right hand radius as  
illustration or left hand  
(The vertical sides of bars  
should face upstream with  
bevel at rear in order to act  
as a weir and direct the flow  
of water into the gully)  
Depth: 152mm  
Coated finish

**C3081001**  
GB325 Grating Size:  
400 x 350mm  
Base size: 585 x 475mm  
Weight: 106.6kg  
Bars Right Hand Radius

**C3081002**  
Bars Left Hand Radius

**C3081011**  
Non-BSS Grating Size:  
500 x 395mm  
Base Size: 710 x 500mm  
Weight: 139.7kg  
Bars Right Hand Radius

**C3081012**  
Bars Left Hand Radius

**PATTERN BX224**



Ductile iron C250  
Double triangular, non-rock  
Large waterway area  
Coated finish  
Clear opening sizes given  
Depth: 75mm

**C3087501**  
Size 435 x 435mm  
Base Size: 580 x 510mm  
Weight: 35kg

**PATTERN BX43**

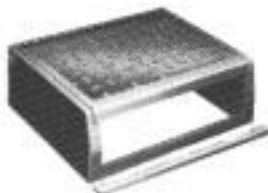

Cast iron kerb type gully  
cover with road retaining bar  
Table 14 Grade E, BS.497/67  
The cover has a vertical fin  
type waterway and forward  
hinged action  
Hinged at front with lift out  
feature to give adequate  
access for cleaning  
Available with anti-flood  
deflector plate to special  
order Supplied to suit half  
battered kerb as standard  
Depth: 200mm  
Coated finish

**TO ORDER ONLY**

Grating Size: 485 x 380mm  
Base Size: 560 x 455mm  
Weight: 114.3kg

**PATTERN BX227**



Ductile iron C250  
Specially designed for  
pedestrian areas  
Can be hinged right or left  
Anti-theft captive hinge  
Coated finish  
Clear opening sizes given  
Depth: 75mm

**C3089001**  
Size: 325 x 312mm  
Base Size: 475 x 400mm  
Weight: 22kg  
Hinged Right Hand

**C3089002**  
Hinged Left Hand

**PATTERN BX68**



Cast iron gully grid,  
medium weight  
Square dishd pattern  
Overall sizes given

**COATED FINISH:**

- C3086001**  
Size: 102 x 102mm
- C3086002**  
Size: 127 x 127mm
- C3086003**  
Size: 152 x 152mm
- C3086004**  
Size: 178 x 178mm
- C3086005**  
Size: 203 x 203mm
- C3086006**  
Size: 229 x 229mm
- C3086007**  
Size: 254 x 254mm
- C3086008**  
Size: 305 x 305mm

**GALVANISED FINISH**

- C3086011**  
Size: 102 x 102mm
- C3086012**  
Size: 127 x 127mm
- C3086013**  
Size: 152 x 152mm
- C3086014**  
Size: 178 x 178mm
- C3086015**  
Size: 203 x 203mm
- C3086016**  
Size: 229 x 229mm
- C3086017**  
Size: 254 x 254mm
- C3086018**  
Size: 305 x 305mm

**PATTERN BX117**

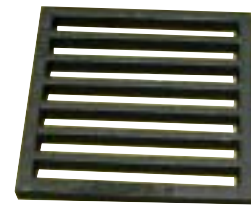

Cast iron gully grid,  
medium weight  
Flat pattern, straight bar  
Overall top sizes given

**COATED FINISH:**

- C3082501**  
Size: 102 x 102mm
- C3082502**  
Size: 127 x 127mm
- C3082503**  
Size: 152 x 152mm
- C3082504**  
Size: 178 x 178mm
- C3082505**  
Size: 229 x 229mm
- C3082506**  
Size: 254 x 152mm
- C3082507**  
Size: 254 x 254mm
- C3082508**  
Size: 305 x 305mm

**GALVANISED FINISH:**

- C3082511**  
Size: 102 x 102mm
- C3082512**  
Size: 127 x 127mm
- C3082513**  
Size: 152 x 152mm
- C3082514**  
Size: 178 x 178mm
- C3082515**  
Size: 229 x 229mm
- C3082516**  
Size: 254 x 152mm
- C3082517**  
Size: 254 x 254mm
- C3082518**  
Size: 305 x 305mm

**PATTERN BX159**

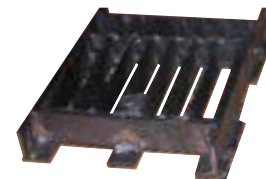

Mild steel Schoolboard  
pattern grating and frame  
Locking pattern  
Flat frame 32 x 32mm with  
lugs. Overall top sizes given

**COATED FINISH:**

- C3084001**  
Size: 150 x 150mm
- C3084002**  
Size: 230 x 230mm
- C3084003**  
Size: 305 x 305mm

**GALVANISED FINISH:**

- C3084011**  
Size: 150 x 150mm
- C3084012**  
Size: 230 x 230mm
- C3084013**  
Size: 305 x 305mm

**KEYS FOR ABOVE GRATINGS**  
**C3084051**

Gratings & Frames

## Gully Gratings & Frames and Surface Boxes

### PATTERN BX64



Cast iron circular grating and frame. Hinged and locking  
Brass lock with key included  
Overall frame sizes given

**COATED FINISH:**  
**C3085001**  
 Size: 140mm Diameter  
 Depth 25mm  
 To Suit Pipe Socket 100mm  
**C3085002**  
 Size: 197mm Diameter  
 Depth 25mm  
 To Suit Pipe Socket 150mm  
**C3085003**  
 Size: 273mm Diameter  
 Depth 35mm  
 To Suit Pipe Socket 230mm  
**C3085004**  
 Size: 368mm Diameter  
 Depth 35mm  
 To Suit Pipe Socket 305mm

**GALVANISED FINISH:**  
**C3085011**  
 Size: 140mm Diameter  
 Depth 25mm  
 To Suit Pipe Socket 100mm  
**C3085012**  
 Size: 197mm Diameter  
 Depth 25mm  
 To Suit Pipe Socket 150mm  
**C3085013**  
 Size: 273mm Diameter  
 Depth 35mm  
 To Suit Pipe Socket 230mm  
**C3085014**  
 Size: 368mm Diameter  
 Depth 35mm  
 To Suit Pipe Socket 305mm

### PATTERN BX63

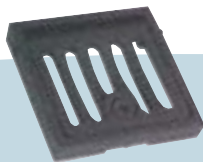

Cast iron Grating and frame  
Hinged and locking  
Brass lock with key included  
Overall frame sizes given

**COATED FINISH:**  
**C3085501**  
 Size: 152 x 152mm  
 Depth 25mm  
**C3085502**  
 Size: 229 x 229mm  
 Depth 25mm  
**C3085504**  
 Size: 254 x 254mm  
 Depth 38mm  
**C3085505**  
 Size: 305 x 305mm  
 Depth 38mm

**GALVANISED FINISH:**  
**C3085511**  
 Size: 152 x 152mm  
 Depth 25mm  
**C3085512**  
 Size: 229 x 229mm  
 Depth 25mm  
**C3085514**  
 Size: 254 x 254mm  
 Depth 38mm  
**C3085515**  
 Size: 305 x 305mm  
 Depth 38mm

### PATTERN BX161



Mild steel Grating  
Flanged frame  
Suitable for asphalt  
Overall top sizes given

**COATED FINISH:**  
**C3084501**  
 Size: 150 x 150mm  
**C3084502**  
 Size: 230 x 230mm  
**C3084503**  
 Size: 305 x 305mm

**GALVANISED FINISH:**  
**C3084511**  
 Size: 150 x 150mm  
**C3084512**  
 Size: 230 x 230mm  
**C3084513**  
 Size: 305 x 305mm

### KEYS FOR GRATINGS

**C3084551**

### PATTERN BX69



Circular pattern gully grid  
Straight bar, medium weight  
Overall sizes given

**COATED FINISH:**  
**C3086501**  
 Size: 76mm Diameter  
**C3086502**  
 Size: 102mm Diameter  
**C3086503**  
 Size: 127mm Diameter  
**C3086504**  
 Size: 152mm Diameter  
**C3086505**  
 Size: 178mm Diameter  
**C3086506**  
 Size: 203mm Diameter  
**C3086507**  
 Size: 229mm Diameter  
**C3086508**  
 Size: 305mm Diameter  
**C3086509**  
 Size: 381mm Diameter

**GALVANISED FINISH:**  
**C3086511**  
 Size: 76mm Diameter  
**C3086512**  
 Size: 102mm Diameter  
**C3086513**  
 Size: 127mm Diameter  
**C3086514**  
 Size: 152mm Diameter  
**C3086515**  
 Size: 178mm Diameter  
**C3086516**  
 Size: 203mm Diameter  
**C3086517**  
 Size: 229mm Diameter  
**C3086518**  
 Size: 305mm Diameter  
**C3086519**  
 Size: 381mm Diameter

### PATTERN BX66



Cast iron Sealing plate and frame  
Circular pattern with 2 brass screws  
Locking pattern  
Overall top sizes given  
Depth: 25mm

**COATED FINISH:**  
**C3090001**  
 Size: 114mm Diameter  
 To Suit Pipe Socket 75mm  
**C3090002**  
 Size: 140mm Diameter  
 To Suit Pipe Socket 100mm  
**C3090003**  
 Size: 191mm Diameter  
 To Suit Pipe Socket 150mm  
**C3090004**  
 Size: 273mm Diameter  
 To Suit Pipe Socket 230mm  
**C3090005**  
 Size: 368mm Diameter  
 To Suit Pipe Socket 305mm

**GALVANISED FINISH**  
**C3090011**  
 Size: 114mm Diameter  
 To Suit Pipe Socket 75mm  
**C3090012**  
 Size: 140mm Diameter  
 To Suit Pipe Socket 100mm  
**C3090013**  
 Size: 191mm Diameter  
 To Suit Pipe Socket 150mm  
**C3090014**  
 Size: 273mm Diameter  
 To Suit Pipe Socket 230mm  
**C3090015**  
 Size: 368mm Diameter  
 To Suit Pipe Socket 305mm

### PATTERN BX120



Cast iron surface box  
Type A light grade  
B5.3461/69  
Hinged lid pattern  
Coated finish  
**C3091001**  
 Size Overall Top:  
152 x 127mm  
 Base Size: 200 x 180mm  
 Depth: 75mm

### PATTERN BX67



Cast iron sealing plate and frame  
Square pattern  
Locking with 2 brass screws  
Overall top sizes given  
Depth: 25mm

**COATED FINISH:**  
**C3090501**  
 Size: 152 x 152mm  
**C3090502**  
 Size: 203 x 203mm  
**C3090503**  
 Size: 229 x 229mm  
**C3090504**  
 Size: 254 x 152mm  
**C3090505**  
 Size: 254 x 254mm  
**C3090506**  
 Size: 305 x 305mm

**GALVANISED FINISH:**  
**C3090511**  
 Size: 152 x 152mm  
**C3090512**  
 Size: 203 x 203mm  
**C3090513**  
 Size: 229 x 229mm  
**C3090514**  
 Size: 254 x 152mm  
**C3090515**  
 Size: 254 x 254mm  
**C3090516**  
 Size: 305 x 305mm

### PATTERN BX121

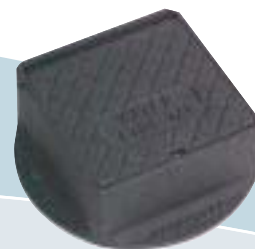

Cast iron surface box Type B  
medium grade B5.3461/69  
Swivel lid pattern  
Coated finish

**C3091501**  
 Size overall top:  
149 x 149mm  
 Base Size: 260mm Dia,  
 Depth: 95mm



**Gully Gratings & Frames and Surface Boxes**

**PATTERN BX122**

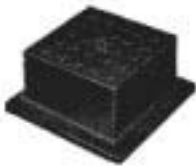

Cast iron surface box  
Type C heavy grade  
B5.3461/69  
Split double triangular lids  
Coated finish

**C3092001**  
Opening Size: 152 x 152mm  
Base Size: 255 x 255mm  
Depth: 150mm

**PATTERN BX123**



Cast iron surface box  
Type D heavy grade  
B5.3461/69  
Split double triangular lids  
Coated finish

**C3092501**  
Opening Size: 228 x 228mm  
Base Size: 330 x 330mm  
Depth: 150mm

**PATTERN BX124**



Cast iron surface box  
Type E heavy grade  
B5.3461/69  
Split double triangular lids  
Coated finish

**C3093001**  
Opening Size: 304 x 304mm  
Base Size: 405 x 405mm  
Depth: 150mm

**PATTERN BX53**

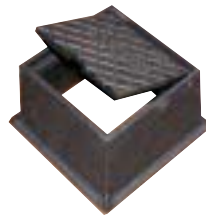

Cast iron stopcock box  
with hinged lid  
Coated finish

**C3093501**  
Opening Size: 114 x 114mm  
Depth: 75mm  
**C3093502**  
Opening Size: 127 x 127mm  
Depth: 100mm  
**C3093503**  
Opening Size: 152 x 152mm  
Depth: 75mm  
**C3093504**  
Opening Size: 229 x 229mm  
Depth: 75mm  
**C3093505**  
Opening Size: 305 x 305mm  
Depth: 100mm

**PATTERN BX126**



Cast iron surface box  
With drop-in lid and chain  
Coated finish

**C3094001**  
Opening Size: 380 x 230mm  
Overall Top: 420 x 255mm  
Depth: 100mm  
Weight: 24.9kg

**C3094002**  
Opening Size: 380 x 230mm  
Overall Top: 440 x 285mm  
Depth: 125mm  
Weight: 52.6kg

**C3094003**  
Opening Size: 495 x 230mm  
Overall Top: 520 x 255mm  
Depth: 100mm  
Weight: 34.4kg

**C3094004**  
Opening Size: 495 x 230mm  
Overall Top: 520 x 255mm  
Depth: 150mm  
Weight: 50.8kg

**C3094005**  
Opening Size: 508 x 380mm  
Overall Top: 560 x 430mm  
Depth: 89mm  
Weight: 52.1kg

**C3094006**  
Opening Size: 535 x 356mm  
Overall Top: 560 x 380mm  
Depth: 125mm  
Weight: 76.2kg

**PATTERN BX45**

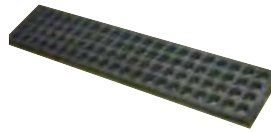

Cast iron Square mesh  
grating fine cast

13mm thickness:  
**C3100002** - 914 x 76mm  
**C3100003** - 610 x 102mm  
**C3100004** - 914 x 102mm  
**C3100005** - 610 x 127mm  
**C3100006** - 914 x 127mm  
**C3100007** - 610 x 152mm  
**C3100008** - 914 x 152mm  
**C3100009** - 610 x 178mm  
**C3100010** - 914 x 178mm  
**C3100011** - 610 x 203mm  
**C3100012** - 914 x 203mm  
**C3100013** - 610 x 229mm  
**C3100014** - 914 x 229mm  
**C3100015** - 610 x 254mm  
**C3100016** - 914 x 254mm  
**C3100017** - 610 x 279mm  
**C3100018** - 914 x 279mm  
**C3100019** - 610 x 305mm  
**C3100020** - 914 x 305mm  
**C3100021** - 610 x 356mm  
**C3100022** - 914 x 356mm  
**C3100023** - 610 x 381mm  
**C3100024** - 914 x 381mm  
**C3100025** - 610 x 457mm  
**C3100026** - 914 x 457mm  
**C3100027** - 610 x 610mm  
**C3100028** - 914 x 610mm

19MM THICKNESS:  
**C3100501** - 610 x 102mm  
**C3100502** - 914 x 102mm  
**C3100503** - 610 x 127mm  
**C3100504** - 914 x 127mm  
**C3100505** - 610 x 152mm  
**C3100506** - 914 x 152mm  
**C3100507** - 610 x 178mm  
**C3100508** - 914 x 178mm  
**C3100509** - 610 x 203mm  
**C3100510** - 914 x 203mm  
**C3100511** - 610 x 229mm  
**C3100512** - 914 x 229mm  
**C3100513** - 610 x 254mm  
**C3100514** - 914 x 254mm  
**C3100515** - 610 x 279mm  
**C3100516** - 914 x 279mm  
**C3100517** - 610 x 305mm  
**C3100518** - 914 x 305mm  
**C3100519** - 610 x 356mm  
**C3100520** - 914 x 356mm  
**C3100521** - 610 x 381mm  
**C3100522** - 914 x 381mm  
**C3100523** - 610 x 457mm  
**C3100524** - 914 x 457mm  
**C3100525** - 610 x 610mm  
**C3100526** - 914 x 610mm

ALSO AVAILABLE 25MM  
THICKNESS

**PATTERN BX46**

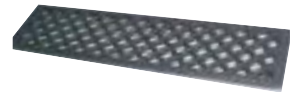

Cast iron diamond mesh  
Grating fine mesh

13mm thickness:  
**C3101502** - 914 x 102mm  
**C3101503** - 610 x 127mm  
**C3101504** - 914 x 127mm  
**C3101505** - 610 x 152mm  
**C3101506** - 914 x 152mm  
**C3101507** - 610 x 178mm  
**C3101508** - 914 x 178mm  
**C3101509** - 610 x 203mm  
**C3101510** - 914 x 203mm  
**C3101511** - 610 x 229mm  
**C3101512** - 914 x 229mm

**PATTERN BX47**



Cast iron heavy duty flat top  
Straight bar grating  
Coated finish

**C3102501** - 610 x 152mm  
Edge Thickness: 38mm  
Centre Thickness: 38mm  
**C3102502** - 610 x 229mm  
Edge Thickness: 51mm  
Centre Thickness: 51mm  
**C3102503** - 610 x 305mm  
Edge Thickness: 63mm  
Centre Thickness: 63mm  
**C3102504** - 610 x 381mm  
Edge Thickness: 63mm  
Centre Thickness: 63mm  
**C3102505** - 610 x 457mm  
Edge Thickness: 63mm  
Centre Thickness: 76mm

**PATTERN BX167TB**



Cast iron heavy duty flat top  
Transverse bar grating

**C3103001** - 610 x 152mm  
Edge Thickness: 38mm  
Centre Thickness: 38mm  
**C3103002** - 610 x 229mm  
Edge Thickness: 51mm  
Centre Thickness: 51mm  
**C3103003** - 610 x 260mm  
Edge Thickness: 51mm  
Centre Thickness: 51mm  
**C3103004** - 610 x 305mm  
Edge Thickness: 51mm  
Centre Thickness: 63mm  
**C3103005** - 610 x 336mm  
Edge Thickness: 51mm  
Centre Thickness: 51mm  
**C3103006** - 610 x 356mm  
Edge Thickness: 63mm  
Centre Thickness: 76mm  
**C3103007** - 610 x 432mm  
Edge Thickness: 63mm  
Centre Thickness: 89mm

Channel & Surface boxes

## Angle Frame and Sash Weights

### PATTERN BX130



Angle framing Fine cast  
To suit channel patterns BX45 and BX46

C3104001 - 610 x 13mm Thickness  
C3104002 - 914 x 13mm Thickness  
C3104011 - 610 x 19mm Thickness  
C3104012 - 914 x 19mm Thickness

### PATTERN BX147



To suit channel patterns BX47 and BX167TB  
Coated finish

C3104501 - 610 x 38mm Thickness  
C3104502 - 610 x 50mm Thickness  
C3104503 - 610 x 65mm Thickness

### PAVEMENT CHANNELS

### PATTERN BX197

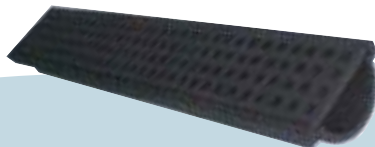

Cast iron half round rebated channel with grating secured by 4 screws  
Coated finish

C3106501 - Inside Diameter: 102mm  
Depth: 51mm Length: 914mm  
C3106502 - Inside Diameter: 152mm  
Depth: 76mm Length: 914mm

### PATTERN BX198CPT

Cast iron as pattern BX197 but with solid chequer plate secured with 4 brass screws  
Coated finish

C3110001 - Inside Diameter: 102mm  
C3110002 - Inside Diameter: 152mm

#### EXTRAS AVAILABLE TO ORDER:

- Cutting channel
- Inlet cut out
- Stop ends for channel
- Outlet spigot

### CAST IRON SASH WEIGHTS

Sizes are Approximate

#### ROUND PATTERN



- C3120001 - Size: 43 x 35mm Dia  
Makeweight: 1/2lb  
C3120002 - Size: 70 x 37mm Dia  
Makeweight: 1lb  
C3120003 - Size: 130 x 38mm Dia  
Makeweight: 2lb  
C3120502 - Size: 173 x 32mm Dia  
Weight: 2lbs  
C3120503 - Size: 216 x 36mm Dia  
Weight: 3lbs  
C3120504 - Size: 279 x 36mm Dia  
Weight: 4lbs  
C3120505 - Size: 295 x 40mm Dia  
Weight: 5lbs  
C3120506 - Size: 330 x 40mm Dia  
Weight: 6lbs  
C3120507 - Size: 390 x 40mm Dia  
Weight: 7lbs  
C3120508 - Size: 510 x 37mm Dia  
Weight: 8lbs  
C3120509 - Size: 565 x 36mm Dia  
Weight: 9lbs  
C3120510 - Size: 476 x 42mm Dia  
Weight: 10lbs  
C3120511 - Size: 550 x 42mm Dia  
Weight: 11lbs  
C3120512 - Size: 570 x 42mm Dia  
Weight: 12lbs  
C3120513 - Size: 578 x 45mm Dia  
Weight: 13lbs  
C3120514 - Size: 595 x 45mm Dia  
Weight: 14lbs

#### SQUARE PATTERN



- C3120515 - Size: 493 x 45mm  
Weight: 15lbs  
C3120516 - Size: 515 x 45mm  
Weight: 16lbs  
C3120517 - Size: 565 x 45mm  
Weight: 17lbs  
C3120518 - Size: 580 x 45mm  
Weight: 18lbs  
C3120519 - Size: 610 x 45mm  
Weight: 19lbs  
C3120520 - Size: 570 x 48mm  
Weight: 20lbs  
C3120521 - Size: 602 x 48mm  
Weight: 21lbs  
C3120522 - Size: 560 x 50mm  
Weight: 22lbs  
C3120523 - Size: 658 x 49mm  
Weight: 23lbs  
C3120524 - Size: 688 x 49mm  
Weight: 24lbs  
C3120525 - Size: 708 x 49mm  
Weight: 25lbs  
C3120526 - Size: 749 x 49mm  
Weight: 26lbs  
C3120527 - Size: 782 x 49mm  
Weight: 27lbs  
C3120528 - Size: 811 x 49mm  
Weight: 28lbs

LEAD SASH WEIGHTS  
WE ARE ABLE TO SUPPLY THESE AS  
AN ALTERNATIVE TO CAST IRON  
YOUR ENQUIRIES ARE INVITED

## Harmer Drain

### HARMER SHOWER DRAIN

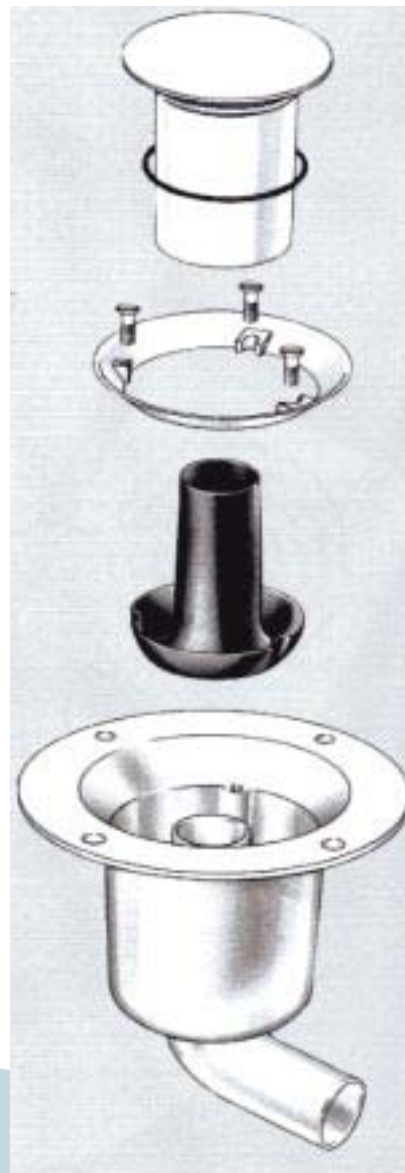

C4060236 - Harmer DHS38  
White Horizontal Spigot Outlet

C4060237 - Harmer DVS38  
White Vertical Spigot Outlet

C4060235 - Harmer CB38  
Clamp and Bell Assembly White

**Classical Cast Iron Rainwater**

**Round Pipes  
Socket & Spigot**

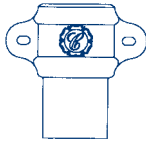

- C3300001 - Size: 65mm  
Length: 6ft
- C3300011 - Size: 75mm  
Length: 6ft
- C3300021 - Size: 100mm  
Length: 6ft

**PLAIN BARRELS**



- C3300005 - Size: 65mm  
Length 1750mm
- C3300015 - Size: 75mm  
Length 1750mm
- C3300025 - Size: 100mm  
Length 1750mm

**LOOSE SOCKET WITH EARS**

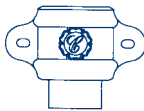

- C3300501 - Size: 65mm
- C3300511 - Size: 75mm
- C3300521 - Size: 100mm

**CAST IRON WALL SPACER  
PLATE**



For use with eared Classical Rainwater

- Pipes and shoes
- C3300601 - 65mm
- C3300611 - 75mm
- C3300621 - 100mm

**WALL BRACKET**

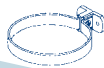

- Galvanised Steel
- C3300701 - 65mm
- C3300711 - 75mm
- C3300721 - 100mm

**ACCESS PIPE**



- C3300801 - 65mm (No Ears)
- C3300811 - 75mm (No Ears)
- C3300821 - 100mm (No Ears)

**RAINWATER DIVERTER KIT**

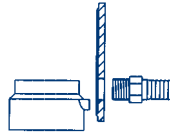

- C3300900 - Suitable for 65mm &  
75mm Access Pipe  
Kit Contains:  
Diverter, Door  
& Nozzle

**SHOE WITH EARS**

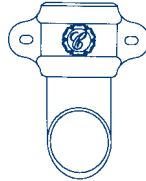

- C3301001 - Size: 65mm
- C3301011 - Size: 75mm
- C3301021 - Size: 100mm

**BEND**



- C3302001 - Size: 65mm 92.5°
- C3302002 - Size: 65mm 112.5°
- C3302003 - Size: 65mm 135°

- C3302011 - Size: 75mm 92.5°
- C3302012 - Size: 75mm 112.5°
- C3302013 - Size: 75mm 135°

- C3302021 - Size: 100mm 92.5°
- C3302022 - Size: 100mm 112.5°
- C3302023 - Size: 100mm 135°

**EQUAL BRANCH**

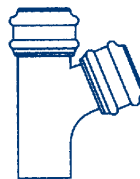

- C3303001 - Size: 65mm 92.5°
- C3303002 - Size: 65mm 112.5°
- C3303003 - Size: 65mm 135°

- C3303011 - Size: 75mm 92.5°
- C3303012 - Size: 75mm 112.5°
- C3303013 - Size: 75mm 135°

- C3303021 - Size: 100mm 92.5°

**OFFSET**

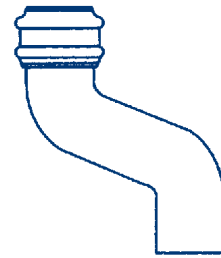

- SIZE: 65MM
- C3302501 - Projection 75mm
- C3302502 - Projection 115mm
- C3302503 - Projection 150mm
- C3302504 - Projection 230mm
- C3302505 - Projection 305mm
- C3302506 - Projection 380mm
- C3302507 - Projection 455mm

- SIZE: 75MM
- C3302511 - Projection 75mm
- C3302512 - Projection 115mm
- C3302513 - Projection 150mm
- C3302514 - Projection 230mm
- C3302515 - Projection 305mm
- C3302516 - Projection 380mm
- C3302517 - Projection 455mm

- SIZE: 100MM
- C3302521 - Projection 75mm
- C3302522 - Projection 115mm
- C3302523 - Projection 150mm
- C3302524 - Projection 230mm
- C3302525 - Projection 305mm
- C3302526 - Projection 380mm
- C3302527 - Projection 455mm

**RECTANGULAR RAINWATER HEAD**



Width 455mm  
Height: 150mm  
Projection: 180mm

- C3335021 - Drop: 75mm
- C3335022 - Drop: 100mm
- C3303504 - Drop: 100 x 75mm  
(Rectangular)

## Classical Cast Iron Rainwater

### RECTANGULAR HEAD

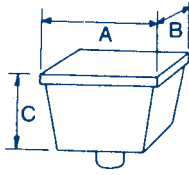

**DIMENSIONS: A X B X C**

- 300 x 250 x 200mm  
C3303501 - Drop: 100mm
- 300 x 250 x 200mm  
C3303502 - Drop: 75mm
- 300 x 250 x 200mm  
C3303503 - Drop: 65mm
- 255 x 180 x 175mm  
C3303511 - Drop: 65mm
- 255 x 180 x 175mm  
C3303512 - Drop: 75mm
- 225 x 125 x 125mm  
C3303521 - Drop: 65mm
- 225 x 125 x 125mm  
C3303522 - Drop: 75mm

### HOPPER HEAD

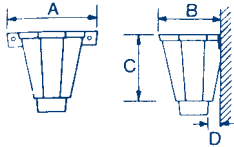

**DIMENSIONS: A X B X C X D**

- 210 x 160 x 185 x 30mm  
C3304001 - Drop: 65mm
- 210 x 160 x 185 x 30mm  
C3304002 - Drop: 75mm
- 250 x 215 x 215 x 38mm  
C3304011 - Drop: 100mm

### RECTANGULAR PIPE SOCKET AND SPIGOT



C3305001 - Size: 100x75mm  
Length: 6ft

### LOOSE SOCKET WITH EARS



C3305501 - 100 x 75mm

### SHOE WITH EARS

Size: 100 x75mm

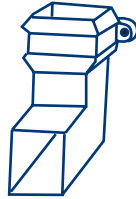

- C3306001 - Front outlet (As illustrated)
- C3306501 - Side Outlet Right Hand
- C3306502 - Side Outlet Left Hand

### FRONT BEND EARED

Size: 100 x75mm

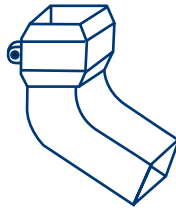

- C3307001 - 92.5°
- C3307002 - 112.5°
- C3307003 - 135°

### BUILD IN HOLDERBAT

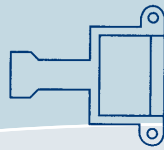

C3308501 - 100 x 75mm

### TREFOIL EARBAND



C3309002 - 100 x 75mm

### PLAIN EARBAND



C3309001 - 100 x 75mm

### SIDE BEND

Size: 100 x75mm

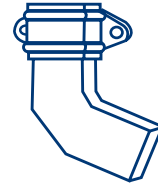

- C3307502 - 112.5° Eared LH
- C3307503 - 112.5° Eared RH

### SIDE BEND

Size: 100 x75mm

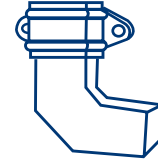

- C3307501 - 92.5° Eared LH
- C3307504 - 92.5° Eared RH

### SIDE BEND

Size: 100 x75mm

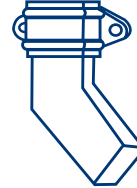

- C3307505 - 135° Eared LH
- C3307506 - 135° Eared RH

### SIDE OFFSET

Size: 100 x 75

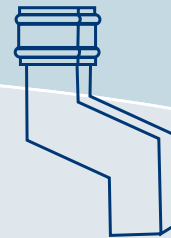

- C3308005 - 75mm Projection No Ears
- C3308006 - 115mm Projection No Ears
- C3308007 - 150mm Projection No Ears
- C3308008 - 225mm Projection No Ears
- C3308009 - 305mm Projection No Ears



**Classical Cast Iron Rainwater**

**HALF ROUND GUTTER**



- C3320001 - 100mm Length: 6ft
- C3320011 - 115mm Length: 6ft
- C3320021 - 125mm Length: 6ft
- C3320031 - 150mm Length: 6ft

**ANGLE (RIGHT HAND) 90°**

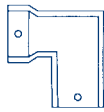

- C3320501 - 100mm
- C3320511 - 115mm
- C3320521 - 125mm
- C3320531 - 150mm

**ANGLE (LEFT HAND) 90°**

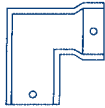

- C3321001 - 100mm
- C3321011 - 115mm
- C3321021 - 125mm
- C3321031 - 150mm

**ANGLE DOUBLE SOCKET 90°**



- C3320601 - 100mm
- C3320611 - 115mm
- C3320621 - 125mm

**ANGLE (RIGHT HAND) 135°**

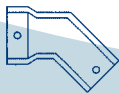

- C3320701 - 100mm
- C3320711 - 115mm
- C3320721 - 125mm
- C3320731 - 150mm

**ANGLE (LEFT HAND) 135°**



- C3320801 - 100mm
- C3320811 - 115mm
- C3320821 - 125mm
- C3320831 - 150mm

**RUBBER GASKET JOINTING KIT FOR HR GUTTER**  
100 x 115 x 125

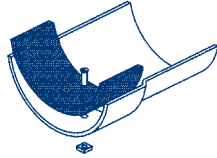

C3320600 - Contains 20 Seals and Nuts/Bolts and Assembly instructions

**STOP END FOR SOCKET**



- C3321501 - 100mm
- C3321511 - 115mm
- C3321521 - 125mm
- C3321531 - 150mm

**STOP END FOR SPIGOT**



- C3322001 - 100mm
- C3322011 - 115mm
- C3322021 - 125mm
- C3322031 - 150mm

**RUNNING OUTLETS**



- C3322501 - Width: 100mm Drop: 65mm
- C3322502 - Width: 100mm Drop: 75mm

- C3322511 - Width: 115mm Drop: 65mm
- C3322512 - Width: 115mm Drop: 75mm

- C3322521 - Width: 125mm Drop: 65mm
- C3322522 - Width: 125mm Drop: 75mm

- C3322531 - Width: 150mm Drop: 75mm
- C3322532 - Width: 150mm Drop: 100mm

**UNION CLIP**



- C3323001 - 100mm
- C3323011 - 115mm
- C3323021 - 125mm
- C3323031 - 150mm

**DROP END WITH SPIGOT**



- C3323501 - Width: 100mm Drop: 65mm
- C3323511 - Width: 115mm Drop: 65mm
- C3323521 - Width: 125mm Drop: 75mm
- C3323531 - Width: 150mm Drop: 75mm
- C3323532 - Width: 150mm Drop: 100mm

**DROP END WITH SOCKET**



- C3324001 - Width: 100mm Drop: 65mm
- C3324011 - Width: 115mm Drop: 65mm
- C3324021 - Width: 125mm Drop: 75mm
- C3324031 - Width: 150mm Drop: 75mm
- C3324032 - Width: 150mm Drop: 100mm

**FASCIA BRACKET**



- C3324501 - Width: 100mm
- C3324511 - Width: 115mm
- C3324521 - Width: 125mm
- C3324531 - Width: 150mm

**O.G. GUTTER**



- C3325001 - 100mm Length: 6ft
- C3325011 - 115mm Length: 6ft
- C3325021 - 125mm Length: 6ft

**O.G. EXTERNAL ANGLE 90°**



- C3325501 - 100mm
- C3325511 - 115mm
- C3325521 - 125mm

**O.G. INTERNAL ANGLE 90°**

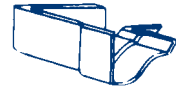

- C3326001 - 100mm
- C3326011 - 115mm
- C3326021 - 125mm

**O.G. ANGLE EXTERNAL 135°**

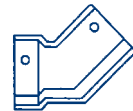

- C3325601 - 100mm
- C3325611 - 115mm
- C3325621 - 125mm

**O.G. ANGLE INTERNAL 135°**

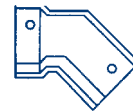

- C3326101 - 100mm
- C3326111 - 115mm
- C3326121 - 125mm

**O.G. STOP END FOR SOCKET (LEFT HAND)**



- C3326501 - 100mm
- C3326511 - 115mm
- C3326521 - 125mm

**O.G. STOP END FOR SPIGOT (RIGHT HAND)**



- C3327001 - 100mm
- C3327011 - 115mm
- C3327021 - 125mm

**RUNNING O.G. OUTLET**

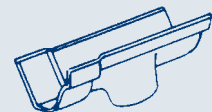

- C3327501 - Width: 100mm Drop: 65mm
- C3327511 - Width: 115mm Drop: 65mm
- C3327521 - Width: 125mm Drop: 65mm
- C3327522 - Width: 125mm Drop: 75mm

## Classical Cast Iron Rainwater

### O.G. UNION CLIP



- C3328001 - 100mm
- C3328011 - 115mm
- C3328021 - 125mm

### O.G. FASCIA BRACKET



- C3329501 - 100mm
- C3329511 - 115mm
- C3329521 - 125mm

### O.G. DROP END WITH SPIGOT

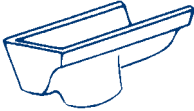

- C3328501 - Width: 100mm  
Drop: 65mm
- C3328511 - Width: 115mm  
Drop: 65mm
- C3328521 - Width: 125mm  
Drop: 65mm
- C3328522 - Width: 125mm  
Drop: 75mm

### O.G. DROP END WITH SOCKET

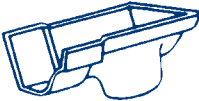

- C3329001 - Width: 100mm  
Drop: 65mm
- C3329011 - Width: 115mm  
Drop: 65mm
- C3329021 - Width: 125mm  
Drop: 65mm
- C3329022 - Width: 125mm  
Drop: 75mm

### MOULDED GUTTER SIZE 125 X 100MM



- C3330011 - Length: 6ft

### MOULDED FASCIA BRACKET SIZE 125 X 100MM



- C3333511 - Cast Iron

### MOULDED UNION CLIP



- C3334011 - 125 x 100mm

### MOULDED INTERNAL ANGLE 90°

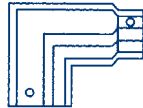

- C3330502 - 125 x 100mm

### MOULDED EXTERNAL ANGLE 90°

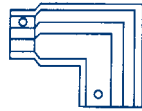

- C3331002 - 125 x 100mm

### MOULDED INTERNAL ANGLE 135°

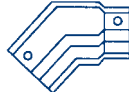

- C3370503 - 125 x 100mm

### MOULDED EXTERNAL ANGLE 135°



- C3371003 - 125 x 100mm

### MOULDED STOP END (LEFT HAND)



- C3331502 - 125 x 100mm

### MOULDED STOP END (RIGHT HAND)

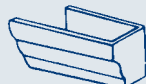

- C3331512 - 125 x 100mm

### MOULDED OUTLET

Size: 125 x 100mm

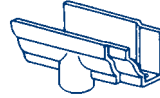

- C3332011 - Drop: 65mm
- C3332012 - Drop: 75mm
- C3332013 - Drop: 100mm

### MOULDED DROP END (LEFT HAND)

Size: 125 x 100mm

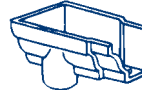

- C3332511 - Drop: 75mm

### (RIGHT HAND)

Size: 125 x 100mm

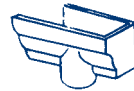

- C3333011 - Drop: 75mm

### SPECIAL PROFILE CAST IRON GUTTERS

In addition to the patterns featured, a range of gutters with special profiles can be obtained. The patterns illustrated below are indicative of patterns available and further details and prices will be given on application.



Deep Half Round



Deep O.G.



Moulded



Box



Boundary Wall



Valley

## Mild Steel Gutter Brackets

### HALF ROUND FASCIA BRACKET



- C3340001 - Size: 100mm
- C3340011 - Size: 115mm
- C3340021 - Size: 125mm
- C3340031 - Size: 150mm

### HALF ROUND DRIVING BRACKET



- C3340501 - Size: 100mm
- C3340511 - Size: 115mm
- C3340521 - Size: 125mm
- C3340531 - Size: 150mm

### HALF ROUND RAFTER BRACKET



#### SIDE FIXING

- C3341001 - Size: 100mm
- C3341011 - Size: 115mm
- C3341021 - Size: 125mm
- C3341031 - Size: 150mm

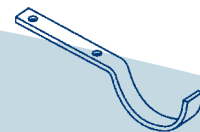

#### TOP FIXING

- C3341501 - Size: 100mm
- C3341511 - Size: 115mm
- C3341521 - Size: 125mm
- C3341531 - Size: 150mm

### HALF ROUND REPAIR BRACKET



- C3342001 - Size: 100mm
- C3342011 - Size: 115mm
- C3342021 - Size: 125mm
- C3342031 - Size: 150mm

**O.G. FASCIA BRACKET**

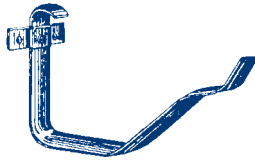

C3342501 - Size: 100mm  
 C3342511 - Size: 115mm  
 C3342521 - Size: 125mm

**O.G. REPAIR BRACKET**



C3343001 - Size: 100mm  
 C3343011 - Size: 115mm  
 C3343031 - Size: 125mm

**GUTTER SCREWS**



30mm x 16g (M7)  
 Galvanized Mushroom Head  
 C3343501

**GUTTER BOLTS AND NUTS**

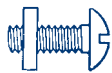

Galvanized M6 x 30  
 C3344001

**GUTTER GUARD**

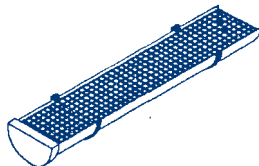

Size: 100mm  
 C3344002  
 Pack of 10 x 500mm  
 Lengths

**PIPE NAILS**



For pipes and drains systems. Raised dome head prevents hammer striking bracket or clamp.

C3281511 - 100mm  
 C3281501 - 75mm

**Timesaver Drain System**

- A. Pipe or fitting
  - B. Pipe or fitting
  - C. Synthetic rubber gasket
  - D. Coupling
  - E. Stainless Steel set screws and nuts
- All couplings have 4 set screws and nuts

Couplings are supplied ready assembled.

1. Slacken bolts to fullest extent.
2. Place Synthetic rubber gasket on end of pipe or fitting A, and slide loosely assembled coupling over pipe B
3. Fit pipe B into gasket ensuring that both A and B are butting against the internal central register.
4. Slide coupling over gasket ensuring that it is centrally located and tighten bolts alternately so that the gap between coupler halves is even on both sides. When hand tight check alignment of assembly.
5. Complete tightening operation by use of a ratchet spanner EF100 and deep socket EF101 until a suitable resistance is achieved. (minimum 20Nm)
6. The ends of the pipes and fittings may be lubricated with Sinclair Foundry products Ensign EC Lube to assist assembly in confined areas. Care being taken to prevent the ingress of dirt, grit etc at the joint.

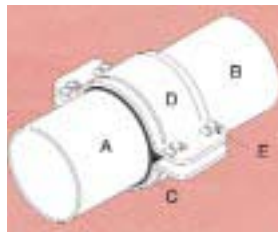

**T000 PIPE DOUBLE SPIGOT**



C3240021 - 100mm x 3m  
 C3240031 - 150mm x 3m

**T001 STANDARD COUPLING**

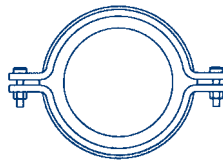

C3240521 - 100mm  
 C3240531 - 150mm

**GT96L CONTINUITY CLIP**

(TO SUIT T001 COUPLING)



C3280111 - 100mm  
 C3280112 - 150mm

**T002 STEPPED COUPLING**

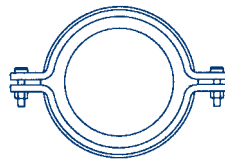

C3241012 - 100mm  
 C3241013 - 150mm

**GT96T CONTINUITY CLIP**

(TO SUIT T002 COUPLING)



C3280112 - 100mm

**GT96T6 CONTINUITY CLIP**

(TO SUIT T002 COUPLING)



C3280113 - 150mm

**EF100 RATCHET SPANNER**



C3400115 - 150mm

**EF098 'T' SPANNER (BOX)**

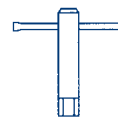

C3400114

**EF101 13MM DEEP SOCKET**



C3400116

**T0640 HANGING BRACKET OR WALL FIXING M12**

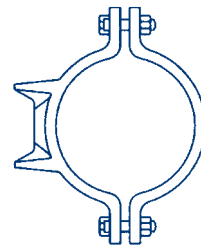

C3242704 - 100mm  
 C3242706 - 150mm

**T006 MEDIUM RADIUS BENDS**

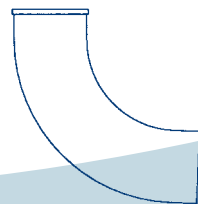

C3243521 - 100 x 87.5°  
 C3243522 - 100 x 80°  
 C3243523 - 100 x 67.5°  
 C3243524 - 100 x 60°  
 C3243525 - 100 x 45°  
 C3243526 - 100 x 35°  
 C3243527 - 100 x 22.5°  
 C3243528 - 100 x 10°  
 C3243531 - 150 x 87.5°  
 C3243532 - 150 x 67.5°  
 C3243533 - 150 x 45°  
 C3243534 - 150 x 35°  
 C3243535 - 150 x 22.5°  
 C3243536 - 150 x 10°

**Timesaver Drain System**

**TD07 MEDIUM RADIUS BEND WITH HEEL REST**

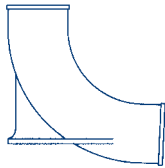

C3246001 · 100 x 87.5°  
C3246011 · 150 x 87.5°

**TD22 LONG RADIUS BEND WITH HEEL REST**

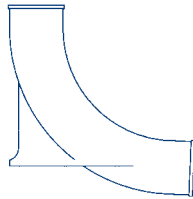

C3246001 · 100 x 87.5°  
C3246011 · 150 x 87.5°

**TD51 BRANCH RIGHT HAND ACCESS**

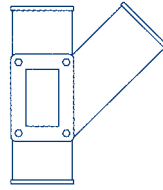

C3250501  
100 x 100 x 87.5°  
C3250502  
100 x 100 x 45°  
C3250552  
150 x 100 x 45°  
C3250503  
150 x 100 x 87.5°

**TD56 ACCESS PIPE**



C3253501 · 100mm  
C3253511 · 150mm

**TD41 DIMINISHING PIPE**

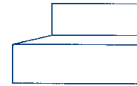

C3254021 · 150 x 100mm

**TD08 MEDIUM RADIUS BEND REAR ACCESS**

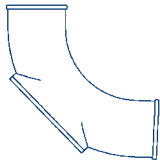

C3244501 · 100 x 87.5°  
C3244511 · 100 x 45°  
C3244502 · 150 x 87.5°  
C3244512 · 150 x 45°

**TD102 BEND LONG TAIL**



C3247501  
815 x 100 x 87.5°

**TD52 BRANCH ACCESS REAR**

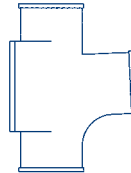

C3251501  
100 x 100 x 87.5°  
C3251502  
100 x 100 x 45°  
C3251503  
150 x 100 x 45°  
C3251504  
150 x 100 x 87.5°

**TD36 SOCKET FERRULE WITH C.I. CAP**

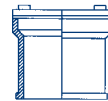

C3254521 · 100mm  
C3254531 · 150mm

**TD34 BLANK CAP PLAIN**



C3255021 · 100mm  
C3255031 · 150mm

**TD09 MEDIUM RADIUS BEND SIDE ACCESS**

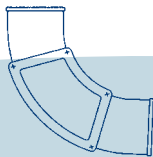

C3245001 · 100 x 87.5°  
C3245002 · 100 x 45°  
C3245011 · 150 x 87.5°  
C3245012 · 150 x 45°

**TD104 BEND LONG TAIL**

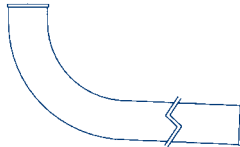

C3247001  
915 x 100 x 87.5°

**TD53 BRANCH LEFT HAND ACCESS**

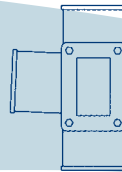

C3251001  
100 x 100 x 87.5°  
C3251002  
100 x 100 x 45°  
C3251003  
150 x 100 x 45°  
C3251004  
150 x 100 x 87.5°

**TD35 BLANK CAP D&T 50MM BSPT**



C3255108 · 100mm  
C3255109 · 150mm

**TD15 LONG RADIUS BEND**

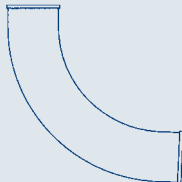

C3245501 · 100 x 87.5°  
C3245511 · 150 x 87.5°

**TD37 BRANCH PLAIN**

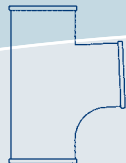

C3250005  
100 x 100 x 87.5°  
C3250011  
100 x 100 x 67.5°  
C3250025  
100 x 100 x 45°  
C3250006  
150 x 100 x 87.5°  
C3250026  
150 x 100 x 45°  
C3250007  
150 x 150 x 87.5°  
C3250027  
150 x 150 x 45°

**TD425 CLEARING ARM BEND**

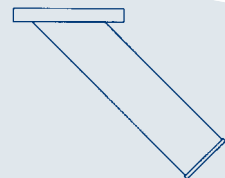

C3248502 · 100 x 45°

**TD447 BRANCH DOUBLE PLAIN**

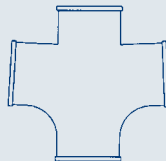

C3252001  
100 x 100 x 87.5°



**Timesaver Drain System**

**TD42**  
TRANSITIONAL PIPE  
SOCKET FOR  
CLAYWARE

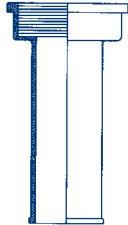

C3255501 - 100mm  
C3255511 - 150mm

**TD43**  
TRANSITIONAL PIPE  
SOCKET  
FOR WC



C3255521 - 100mm

**TD47** TRANSITIONAL  
PIPE SOCKET  
FOR C.I. TO  
BS437

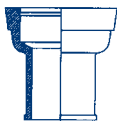

C3255541 - 100mm  
C3255542 - 150mm

**TD118** TRANSITIONAL  
PIPE ADAPTOR  
(FROM TIMESAVER DRAIN TO  
SUPERSLEEVE)



C3255601 - 100mm  
C3255602 - 150mm

**TD60** GULLY TRAP  
PLAIN

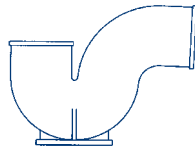

C3256011 - 100 x 87.5°  
C3256021 - 150 x 87.5°  
C3256012 - 100 x 45°  
C3256013 - 100 x 180°

**TD107** GULLY TRAP  
WITH  
SURFACE ACCESS

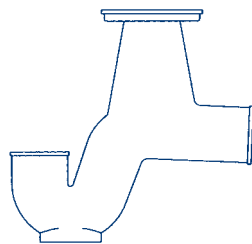

C3256501 - 100 x 87.5°

**TD64** GULLY TRAP  
WITH 225MM INLET



C3257001 - 100 x 87.5°

**TD475** RUNNING  
TRAP WITH DOUBLE  
ACCESS



C3257002 - 100mm  
C3257003 - 150mm

**TD 500** GULLY  
INLET PLAIN

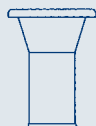

C3269001  
100mm Body Only

**TD105** GULLY INLET  
WITH  
HORIZONTAL BRANCH

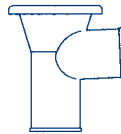

C3261501  
100 x 100mm Body Only

**TD106** GULLY INLET  
WITH  
VERTICAL BRANCH

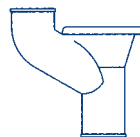

C3262001  
100 x 100mm Body Only

**TD525** RAISING  
PIECE PLAIN



C3269501  
100 x 75mm High  
C3269503  
100 x 150mm High  
C3269504  
100 x 225mm High  
C3269505  
100 x 300mm High

**TD611** NOTCHED  
GRATE



C3264501 - 200mm

**TD612**  
PLAIN GRATE



C3265001 - 200mm

**TD613** SOLID COVER



C3265501 - 200mm

**TD614** HINGED &  
LOCKING GRATE



C3265502 - 200mm

**TD615** SEALED  
PLATE & FRAME

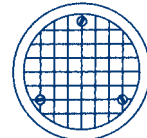

C3266001 - 200mm

**TD616** SEALED  
PLATE & FRAME



C3266501 - 200mm

**TD678** RAISING  
PIECE PLAIN

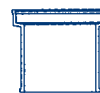

C3270501 - 75mm High  
C3270502 - 115mm High  
C3270503 - 150mm High  
C3270504 - 225mm High  
C3270505 - 300mm High

**TD108** RAISING  
PIECE  
WITH 100MM INLET



C3270506 - 225mm High

**TD111** RAISING  
PIECE

(With 3 x 100 90° Inlets)

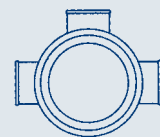

C3270507 - 225mm High

## Timesaver Drain System

**TD684 GULLY INLET PLAIN**

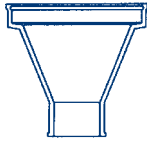

C3270508 - 100mm  
C3270509 - 150mm

**TD652 NOTCHED GRATE**



C3267501 - 265mm

**TD550 DEANS TRAP 600MM DEEP**

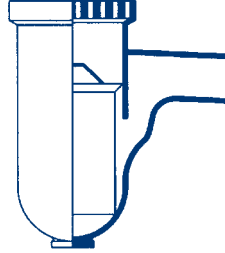

C3258501 100 x 87.5°  
C3258502 Galv. Sediment Pan

**TD559 RAISING PIECE FOR TD554**

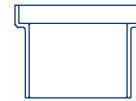

C3270001 - 75mm High  
C3270003 - 150mm High  
C3270004 - 300mm High

**TD120 GULLY INLET (WITH 100MM INLET)**

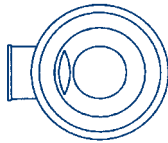

C3263001 - 100 x 100mm

**TD653 HINGED & LOCKING GRATE**



C3267502 - 265mm

**TD551 GULLY TRAP 425MM DEEP**

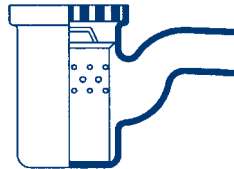

C3259001 100 x 87.5°  
C3259002 Galv. Sediment Pan

**TD556 GARAGE GULLY (225 X 600MM DEEP)**

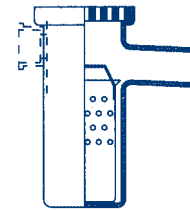

C3260501 100 x 87.5°  
C3260502 Galv. Sediment Pan

**TD123 GULLY INLET (WITH 3 X 100MM 90° INLET)**

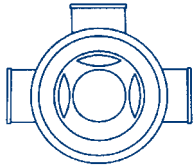

C3263002 - 100 x 100mm

**TD661 SEALED PLATE & FRAME**



C3267503 - 265mm

**TD553 GULLY TRAP SQUARE (TOP 225 X 225MM)**

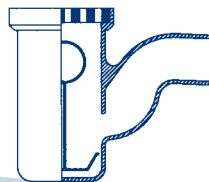

C3259501 100 x 87.5°  
C3259502 Galv. Sediment Pan  
C3259503 Grate to Suit

**TD558 GARAGE GULLY (325 X 600MM DEEP)**

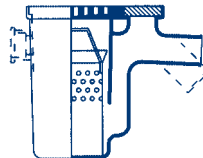

C3261001 100 x 87.5°  
C3261011 100 x 45°  
C3261022 Galv. Sediment Pan  
C3261023 Grate to Suit

**TD650 LIGHT GRATE**



C3267001 - 265mm

**TD662 GREASE SEALED COVER & FRAME**



C3268501 - 265mm

**TD554 GARAGE GULLY (300 X 600MM DEEP)**

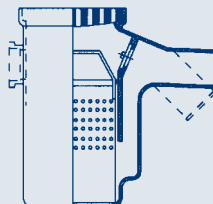

C3260001 100 x 87.5°  
C3260021 100 x 45°  
C3260032 Galv. Sediment Pan  
C3260033 Grate to Suit

(Available with 1, 2 or 3 Fresh Air Inlets)

**TD651 HEAVY GRATE**



C3268002 - 265mm

**TD467 TRAPLESS GULLY**

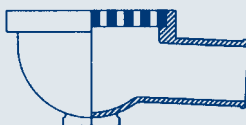

C3258001 100 x 87.5°

**TD114 RAINWATER SHOE WITH HORIZONTAL OUTLET**

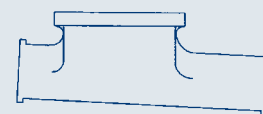

C5030201 - 100mm

**Timesaver Drain System**

**TD793 RAISING PIECE FOR TD114**



C5030202 - 75mm High  
C5030203 - 300mm High

**TD724 AIRTIGHT INSPECTION EYE COVER**

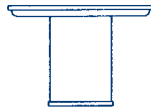

C5030209 - 100mm  
C5030210 - 150mm

**TD14 INSPECTION CHAMBERS (ONE BRANCH EACH SIDE)**

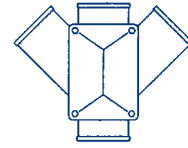

C3273001 - 100 x 100mm  
C3273002 - 150 x 100mm  
C3273003 - 150 x 150mm

**TD790 GRATE**

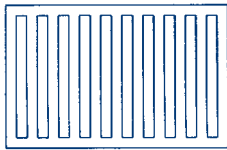

C5030204 - For TD114 & 793

**TD777 LOOSE PUDDLE FLANGE**

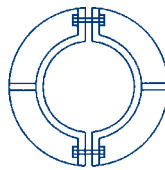

C3271001 - 100mm  
C3288555 - 150mm

**TD791 HINGED & LOCKING GRATE**



C5030205 - For TD114 & 793

**TD706 GREASE TRAP WITH SINGLE SEAL COVER (FOR INTERNAL & EXTERNAL USE)**

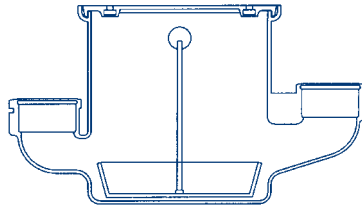

C3288556 - Body  
C3288557 - Cover  
C3288558 - Galv. Sediment Pan

**TD17 INSPECTION CHAMBER (TWO BRANCHES EACH SIDE)**

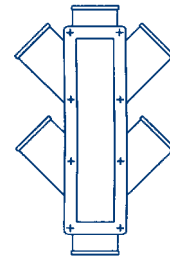

C3273004 - 100 x 100mm  
C3273005 - 150 x 100mm  
C3273006 - 150 x 150mm

**TD792 GREASE SEALED COVER & FRAME**

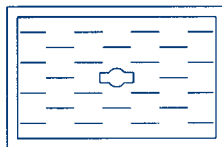

C5030206 - For TD114 & 793

**TD750 ANTI-FLOOD TRUNK VALVE 'EUREKA'**

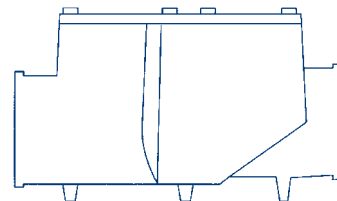

C327007 - 150mm

**TD795 HINGED & LOCKING COVER & FRAME**

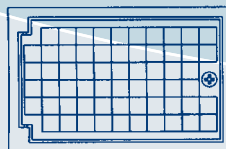

C5030207 - For TD114 & 793

**TD708 GREASE TRAP OUTLET (FOR USE WITH TD706)**

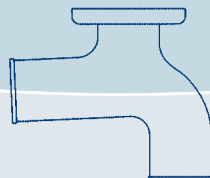

C3288559 - 87.5° Outlet

## Timesaver Soil System

- A. Pipe or fitting
  - B. Pipe or fitting
  - C. Synthetic rubber gasket
  - D. Coupling
  - E. Stainless Steel set screws and nuts
- All couplings have 4 set screws and nuts

Couplings are supplied ready assembled.

1. Slacken bolts to fullest extent.
2. Place Synthetic rubber gasket on end of pipe or fitting A, and slide loosely assembled coupling over pipe B
3. Fit pipe B into gasket ensuring that both A and B are butting against the internal central register.
4. Slide coupling over gasket ensuring that it is centrally located and tighten bolts alternately so that the gap between coupler halves is even on both sides. When hand tight check alignment of assembly.
5. Complete tightening operation by use of a ratchet spanner EF100 and deep socket EF101 until a suitable resistance is achieved. (minimum 20Nm)
6. The ends of the pipes

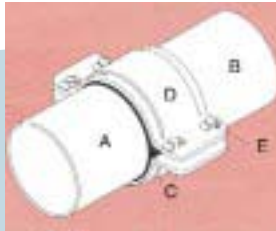

### GT01 STANDARD COUPLING

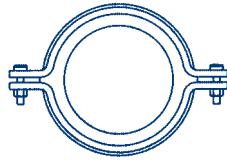

C3190301 - 50mm  
C3200501 - 75mm  
C3200511 - 100mm  
C3200521 - 150mm

### GT96S CONTINUITY CLIP

(TO SUIT GT01 COUPLING)



C3280101  
50mm/75mm/100mm

### GT96L CONTINUITY CLIP

(TO SUIT GT01 COUPLING)



C3280102 - 150mm

### GT12 CONVERSION COUPLING

(Connects to 70mm Ensign)



C3200601 - 65 x 75mm  
C3200602 - 70 x 75mm  
C3200611 - 90 x 100mm

### EF101 13MM DEEP SOCKET



C3400116

### GT48 WALL FIXING BRACKET



C3192301 - 50mm  
C3201301 - 75mm  
C3201302 - 100mm  
C3201303 - 150mm

### GT100 MILD STEEL FIXING BRACKET



C3280501 - 100mm  
C3280511 - 75mm

### GT101 MILD STEEL SUSPENSION BRACKET

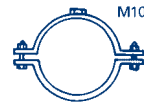

C3280521  
75mm - 10mm Stud  
C3280531  
100mm - 10mm Stud

### GT02 SHORT RADIUS BEND PLAIN

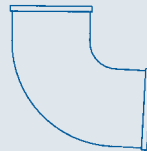

C3192501 - 50 x 87.5°  
C3202501 - 75 x 87.5°  
C3202511 - 100 x 87.5°  
C3202521 - 150 x 87.5°  
C3202513 - 100 x 67.5°  
C3192503 - 50 x 45°  
C3202503 - 75 x 45°  
C3202514 - 100 x 45°  
C3202523 - 150 x 45°  
C3202515 - 100 x 11°

### GT03 SHORT RADIUS BEND

(REAR ACCESS)

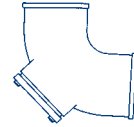

C3193001 - 50 x 87.5°  
C3203001 - 75 x 87.5°  
C3203011 - 100 x 87.5°  
C3203021 - 150 x 87.5°  
C3203003 - 75 x 45°  
C3203014 - 100 x 45°  
C3203023 - 150 x 45°

### GT104 SHORT RADIUS BEND

(SIDE ACCESS)

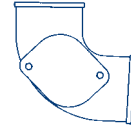

C3203511 - 100 x 87.5°

### GT02L LONG RADIUS BEND PLAIN

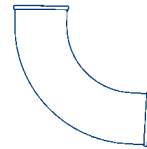

C3204001 - 75 x 87.5°  
C3204011 - 100 x 87.5°  
C3204021 - 150 x 87.5°  
C3204014 - 100 x 45°  
C3204015 - 100 x 22.5°  
C3204025 - 150 x 22.5°  
C3204016 - 100 x 5°

### GT03L LONG RADIUS BEND

(REAR ACCESS)

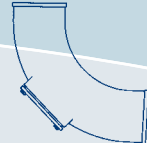

C3204501 - 75 x 87.5°  
C3204511 - 100 x 87.5°  
C3204521 - 150 x 87.5°

### GT04L LONG RADIUS BEND

(SIDE ACCESS)

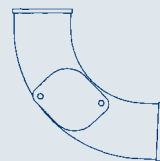

C3205011 - 100 x 87.5°

### GT00 PIPE DOUBLE SPIGOT



C3190000 - 50mm x 3m  
C3200001 - 75mm x 3m  
C3200011 - 100mm x 3m  
C3200021 - 150mm x 3m

### EF100 RATCHET SPANNER

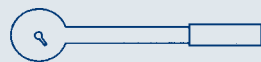

C3400115

### EF098 'T' SPANNER (BOX)

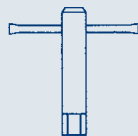

C3400114



**Timesaver Soil System**

**GT43 BEND  
LONG TAIL**

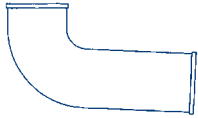

**C3205501**  
250 x 100 x 87.5°

**GT56 BRANCH  
LONG TAIL**



**C3213001**  
915 x 100 x 100 x 87.5°

**GT10 BRANCH  
DOUBLE PLAIN**

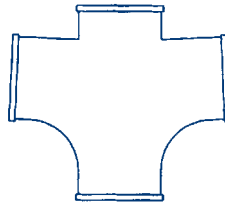

**C3212011**  
75 x 75 x 87.5°  
**C3212041**  
100 x 100 x 87.5°  
**C3212051**  
150 x 100 x 87.5°  
**C3212044**  
100 x 100 x 45°

**GT14 ACCESS PIPE  
ROUND DOOR**



**C3214501** · 75mm  
**C3214511** · 100mm  
**C3214521** · 150mm

**GT55 BEND  
LONG TAIL**

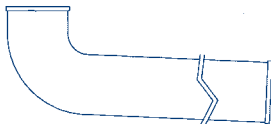

**C3205511**  
815 x 100 x 87.5°

**GT07 BRANCH  
(REAR ACCESS)**

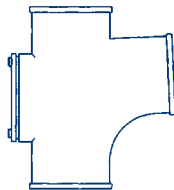

**GT11 BRANCH  
DOUBLE ACCESS**

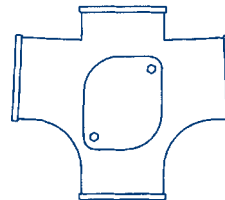

**C3212541**  
100 x 100 x 87.5°

**GT15 ACCESS PIPE  
SQUARE DOOR**

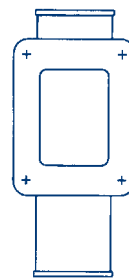

**C3215001** · 100mm  
**C3215011** · 150mm

**GT06 BRANCH  
PLAIN**

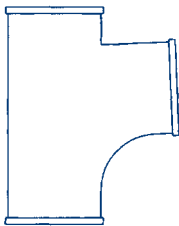

**C3194001**  
50 x 50 x 87.5°  
**C3210001**  
75 x 50 x 87.5°  
**C3210011**  
75 x 75 x 87.5°  
**C3210021**  
100 x 50 x 87.5°  
**C3210031**  
100 x 75 x 87.5°  
**C3210041**  
100 x 100 x 87.5°  
**C3210071**  
150 x 100 x 87.5°  
**C3210081**  
150 x 150 x 87.5°  
**C3210043**  
100 x 100 x 67.5°  
**C3194003**  
50 x 50 x 45°  
**C3210003**  
75 x 50 x 45°  
**C3210013**  
75 x 75 x 45°  
**C3210023**  
100 x 50 x 45°  
**C3210033**  
100 x 75 x 45°  
**C3210044**  
100 x 100 x 45°  
**C3210075**  
150 x 100 x 45°  
**C3210082**  
150 x 150 x 45°

**C3194501**  
50 x 50 x 87.5°  
**C3210501**  
75 x 50 x 87.5°  
**C3210511**  
75 x 75 x 87.5°  
**C3210521**  
100 x 50 x 87.5°  
**C3210531**  
100 x 75 x 87.5°  
**C3210541**  
100 x 100 x 87.5°  
**C3210571**  
150 x 100 x 87.5°  
**C3210581**  
150 x 150 x 87.5°  
**C3210544**  
100 x 100 x 45°  
**C3210573**  
150 x 100 x 45°

**GT08 BRANCH RH  
(SIDE ACCESS)**

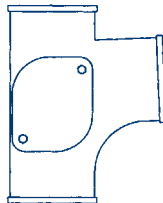

**GT32 PARALLEL  
BRANCH**

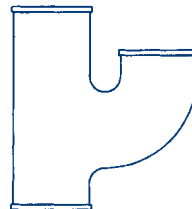

**C3213513**  
100 x 100mm

**GT45 W.C.  
CONNECTOR**

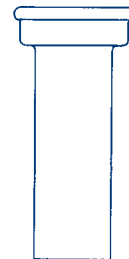

**C3216001** · 100mm

**GT09 BRANCH LH  
(SIDE ACCESS)**

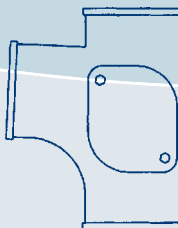

**C3211541**  
100 x 100 x 87.5°

**GT35 CORNER  
BRANCH**

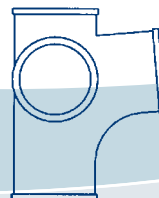

**C3214001**  
100 x 100 x 87.5°

**GT24 OFFSET**

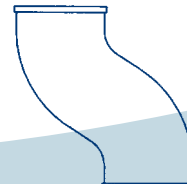

**C3216501**  
75 x 75mm Projection  
**C3216502**  
75 x 115mm Projection  
**C3216503**  
75 x 150mm Projection  
**C3216511**  
100 x 75mm Projection  
**C3216512**  
100 x 115mm Projection  
**C3216513**  
100 x 150mm Projection  
**C3216514**  
100 x 225mm Projection  
**C3216515**  
100 x 300mm Projection

Cast Iron Soil

## Timesaver Soil System

### GT28 TAPER

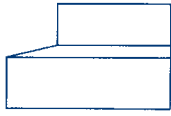

- C3217001 - 75 x 50mm
- C3217011 - 100 x 50mm
- C3217021 - 100 x 75mm
- C3217031 - 150 x 100mm

### GT73 ROOF VENT CONNECTOR FOR ASPHALT

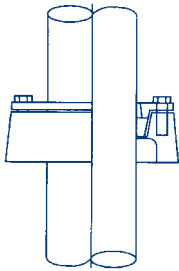

C3198504 - 100mm

### GT70 BLANK CAP PLAIN



- C3217611 - 50mm
- C3217501 - 75mm
- C3217511 - 100mm
- C3217521 - 150mm

### GT71 BLANK CAP D & T 50



- C3217603 - 75mm
- C3217606 - 100mm
- C3217609 - 150mm

### EF071R UNIVERSAL CONNECTOR (EPDM)



- C3217610 - 50 x 56/48/40 (OD Dimension)

### GT34 'P' TRAP PLAIN

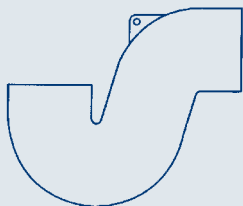

C3220011 - 100mm

### GT37 'P' TRAP WITH HEEL ACCESS

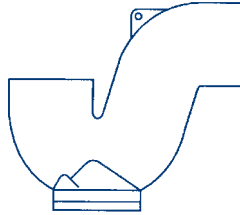

- C3198501 - 50mm No Support Lug
- C3220501 - 75mm No Support Lug
- C3220511 - 100mm
- C3220521 - 150mm

### GT483 BELLMOUTH GULLY INLET



- C3223011 - 100mm
- C3223012 - Grate to Suit

### ED078 LOOSE PUDDLE FLANGE

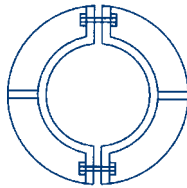

- C3401134 - 100mm Grey Epoxy Coated

### GT106 BOSS PIPE 150MM LONG

(SINGLE BOSS - 2" BSPT)

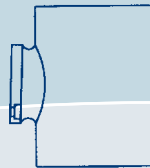

- C3400101 - 50mm
  - C3228005 - 75mm\*
  - C3228006 - 100mm
  - C3228003 - 150mm
- \*Will remain drilled 2" BSPT

### GT109 BOSS PIPE 150MM LONG

(2 X 2" BOSSES OPPOSED)

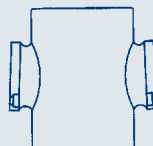

C3228012 - 100mm

### GT115 BOSS PIPE 150MM LONG

(2 X 2" BOSSES AT 90°)

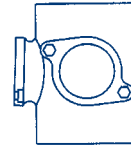

C3228024 - 100mm

### GT133 STRAP ON BOSS

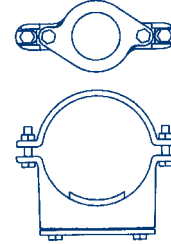

- C3228040 - 100mm Diameter Strap on Boss
- C3228041 - Hole Saw Arbour With Drill
- C3228042 - 64mm Hole Saw for Cast Iron
- C3228043 - Pilot Drill

### GT132 BOSS PIPE 240MM LONG

(2 X 2" BOSSES IN LINE)



C3228502 - 100mm

### GT06 BRANCH WITH 1 x 2" BSPT BOSS

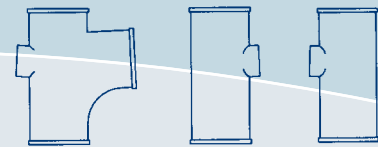

Boss Back      Boss RH      Boss LH

- C3228503 - Back Boss x 100mm
- C3228504 - RH Boss x 100mm
- C3228505 - LH Boss x 100mm

### GT707 GREASE TRAP

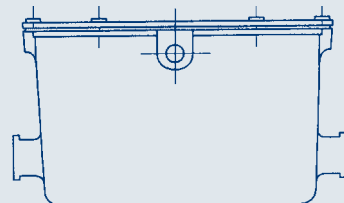

- C3228506 - 50mm Outlet
- C3228507 - Galv. Sediment Pan

**Ensign Drainage System**

Complete Cast Iron Drainage Systems for above & below ground to BS EN877

**ABOVE GROUND**

**EPO00 PIPE**



- C3400001 - 50mm x 3m
- C3400002 - 70mm x 3m
- C3400003 - 100mm x 3m
- C3410001 - 150mm x 3m

**EC002 COUPLING  
TWO PIECE DUCTILE**



- C3400004 - 50mm
- C3400005 - 70mm
- C3400006 - 100mm
- C3410002 - 150mm

**EC001P Push Fit  
JOINT NO EARS**



- C3401138 - 50mm
- C3401139 - 70mm
- C3401140 - 100mm
- C3410003 - 150mm

**EC001E Push Fit  
JOINT EARED**



- C3401141 - 50mm
- C3401142 - 70mm
- C3401143 - 100mm
- C3410004 - 150mm

**EC001S SLIP JOINT**



- C3401144 - 50mm
- C3401145 - 70mm
- C3401146 - 100mm
- C3410005 - 150mm
- C3401147 - Single Gasket(s) To Suit Push Fit Joint

**EC001T REDUCING  
GASKET**

- C3401151  
To suit PFJ 100 x 90mm Reduces 100mm Push Fit Joint To 90mm Soil Pipe

**CAST IRON WALL  
SPACER PLATE**



- C3401148 - 50mm
- C3401149 - 70mm
- C3401150 - 100mm

(To suit eared Push-Fit Joints EC001E)

**EF049 PIPE BRACKET  
DUCTILE IRON**



- C3400007 - 50mm
- C3400008 - 70mm
- C3400009 - 100mm
- C3410006 - 150mm

**EF048 PIPE BRACKET  
DUCTILE IRON**



- C3400012

**EF098 TEE BOX  
SPANNER**

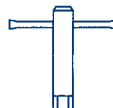

- C3400114

**EF100  
RACHET SPANNER**



- C3400115

**EF101 DEEP SOCKET**



- C3400116 - 13mm

**EF102 ALLEN KEY  
SOCKET ADAPTOR**



- C3400117

**EF002 BEND SHORT  
RAD.**



- C3400013 - 50 x 88°
- C3400014 - 70 x 88°
- C3400015 - 100 x 88°
- C3410007 - 150 x 88°

**EF002 BEND SHORT  
RAD.**



- C3400016 - 50 x 69°
- C3400017 - 70 x 69°
- C3400018 - 100 x 69°
- C3410008 - 150 x 69°



- C3400019 - 50 x 45°
- C3400020 - 70 x 45°
- C3400021 - 100 x 45°
- C3410009 - 150 x 45°



- C3400022 - 50 x 30°
- C3400023 - 70 x 30°
- C3400024 - 100 x 30°
- C3410010 - 150 x 30°



- C3400025 - 50 x 15°
- C3400026 - 70 x 15°
- C3400027 - 100 x 15°
- C3410011 - 150 x 15°

**EF02L BEND LONG  
RAD.**

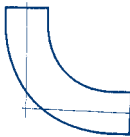

- C3400029 - 100 x 88°
- C3410012 - 150 x 88°
- C3400030 - 100 x 22°

**EF005 BEND SHORT  
RAD. DOOR BACK**



- C3400032 - 70 x 88°
- C3400033 - 100 x 88°
- C3410013 - 150 x 88°

**EF05L BEND LONG  
RAD. DOOR BACK**

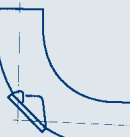

- C3400034 - 100 x 88°

**EF055 BEND  
LONG TAIL**

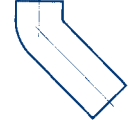
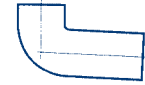

- C3400035 - 100 x 88°
- C3400036 - 100 x 45°

**EF054 BEND  
LONG TAIL DOUBLE**

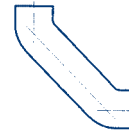

- C3400037 - 70 x 88°
- C3400038 - 100 x 88°

**EF057 AIR PIPE**



- C3400039 - 100 x 135°

**EF006 BRANCH  
SINGLE**



- C3400040 - 50 x 50 x 88°
- C3400041 - 70 x 50 x 88°
- C3400042 - 70 x 70 x 88°
- C3400043 - 100 x 50 x 88°
- C3400044 - 100 x 70 x 88°
- C3400045 - 100 x 100 x 88°
- C3410014 - 150 x 100 x 88°
- C3410015 - 150 x 150 x 88°

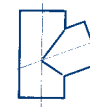

- C3400046 - 50 x 50 x 69°
- C3400047 - 70 x 50 x 69°
- C3400048 - 70 x 70 x 69°
- C3400049 - 100 x 100 x 69°
- C3400050 - 100 x 70 x 69°
- C3400051 - 100 x 100 x 69°
- C3410016 - 150 x 100 x 69°



- C3400052 - 50 x 50 x 45°
- C3400053 - 70 x 50 x 45°
- C3400054 - 70 x 70 x 45°
- C3400055 - 100 x 50 x 45°
- C3400056 - 100 x 70 x 45°
- C3400057 - 100 x 100 x 45°
- C3410017 - 150 x 70 x 45°
- C3410018 - 150 x 100 x 45°
- C3410019 - 150 x 150 x 45°

## Ensign Drainage System

EF06R BRANCH SINGLE EF035 CORNER BRANCH EF037 'P' TRAP PLAIN EF071R UNIVERSAL

(RADIUS)



- C3400058 - 70 x 70 x 88°
- C3400059 - 100 x 50 x 88°
- C3400060 - 100 x 70 x 88°
- C3400061 - 100 x 100 x 88°
- C3410020 - 150 x 100 x 88°
- C3410021 - 150 x 150 x 88°

EF07R BRANCH SINGLE (RAD.ACCESS)



- C3400062 - 70 x 70 x 88°
- C3400063 - 100 x 50 x 88°
- C3400064 - 100 x 70 x 88°
- C3400065 - 100 x 100 x 88°
- C3410022 - 150 x 100 x 88°
- C3410023 - 150 x 150 x 88°

EF010 BRANCH DOUBLE

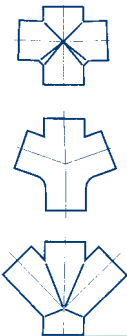

- C3400066 - 100 x 100 x 88°
- C3400067 - 100 x 100 x 69°
- C3400068 - 100 x 100 x 45°
- C3410024 - 150 x 100 x 45°
- C3410025 - 150 x 150 x 45°

EF010R BRANCH DOUBLE (RADIUS)



- C3401151 - 100 x 100 x 88°
- C3410026 - 150 x 100 x 88°

EF056 BRANCH LONG TAIL



- C3400070 - 100 x 100 x 88°



- C3400071 - 100 x 100 x 88°

EF036 CORNER BRANCH LONG TAIL



- C3400072 - 100 x 100 x 88°

EF014 ACCESS PIPE (ROUND ACCESS)



- C3400073 - 50mm
- C3400074 - 70mm
- C3400075 - 100mm
- C3410027 - 150mm

EF015 ACCESS PIPE (RECT.ACCESS)



- C3400076 - 100mm
- C3410028 - 150mm

EF024 OFFSET



- C3400077 - 100 x 75 Offset
- C3400078 - 50 x 130 Offset
- C3400079 - 70 x 130 Offset
- C3400080 - 100 x 130 Offset

EF028 PIPE TAPER



- C3400081 - 70 x 50
- C3400082 - 100 x 50
- C3400083 - 100 x 70
- C3410029 - 150 x 50
- C3410030 - 150 x 70
- C3410031 - 150 x 100

EF034 TRAP 'P' PLAIN

(Supplied without support lug)



- C3400084 - 100mm

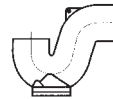

- C3400085 - 50mm\*
  - C3400086 - 70mm
  - C3400087 - 100mm
  - C3410032 - 150mm
- \*Supplied without support lug

EF080 BRANCH TRAP

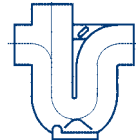

- C3400088 - 100mm

EF073 CONNECTOR ROOF (FOR ASPHALT)

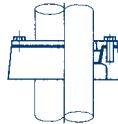

- C3400090 - 100mm

EF058 CONNECTOR MOVEMENT

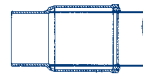

- C3400091 - 100mm
- C3410033 - 150mm

EF074 EXPANSION PLUGS



- C3400092 - 70mm
- C3400093 - 100mm
- C3410034 - 150mm

EF070 BLANK END (PLAIN)



- C3400094 - 50mm
- C3400095 - 70mm
- C3400096 - 100mm
- C3410035 - 150mm

EF071 BLANK END (DRILLED & TAPPED)



- C3400097 - 70 x 2" B.S.P.
- C3400098 - 100 x 2" B.S.P.
- C3410036 - 150 x 2" B.S.P.

CONNECTOR (EPDM)



- C3401152 - 50 x 56/48/40mm (OD Dimensions)

EF077 BLANK END (PUSH-FIT CONNECTOR)



- C3400099 - 100 x 38/32mm Waste

EF076 MULTI INLET WASTE CONNECTOR



- C3401153

EF090 BOSS PIPE (COMPRESSION 50MM)

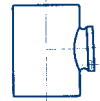

- C3400101 - 50mm
- C3400102 - 70mm
- C3400103 - 100mm
- C3410037 - 150mm

EF091 BOSS PIPE (COMPRESSION OPPOSED 50mm)

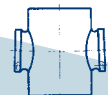

- C3400104 - 100mm

EF092 BOSS PIPE (COMPRESSION)

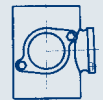

- C3400105 - 100mm

EF094 MANIFOLD CONNECTOR

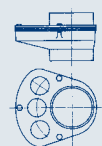

- C3400106 - 100mm
- C3410038 - 150mm



**Ensign Drainage System**

**EF050 STACK SUPPORT PIPE**

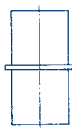

C3400107 - 70mm  
C3400108 - 100mm  
C3410039 - 150mm

**EF051 STACK SUPPORT BRACKET (SUPPLIED WITH RUBBER SEAL)**



C3400111 - 70mm  
C3400112 - 100mm  
C3410040 - 150mm

**EF059 CONNECTOR (TRANSITIONAL)**



C3400113 - 100mm  
C3410041 - 150mm

**EC0931 ANCILLARY PRODUCTS**

C3400118 - Ensign EC Lube

Temporary lubricating agent for Ensign Couplings & other mechanical joints.  
1 litre bottle.

**BELOW GROUND**

**ED001 PIPE**



C3401101 - 100mm x 3m  
C3420001 - 150mm x 3m

**ED001 COUPLING TWO PIECE DUCTILE**



C3401102 - 100mm  
C3420002 - 150mm  
*\*No Continuity Nibs on ED001 Couplings*

**ED048 PIPE BRACKET DUCTILE IRON**



C3401103 - 100mm  
C3420003 - 150mm

**ED002 BEND SHORT RADIUS**



C3401105 - 100 x 45°  
C3420004 - 150 x 45°

**ED002 BEND SHORT RADIUS**



C3401106 - 100 x 30°  
C3420005 - 150 x 30°

**ED002 BEND SHORT RADIUS**



C3401107 - 100 x 15°  
C3420006 - 150 x 15°

**ED02M BEND MEDIUM RAD.**



C3401108 - 100 x 45°  
C3420007 - 150 x 45°

**ED02L BEND LONG RAD.**

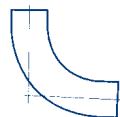

C3401109 - 100 x 88°  
C3420008 - 150 x 88°  
C3401110 - 100 x 22°

**ED007 HEEL REST BEND**

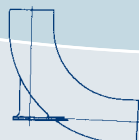

C3401111 - 100mm  
C3420009 - 150mm

**ED05L BEND LONG RAD. DOOR BACK**

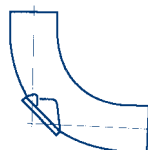

C3401112 - 100 x 88°

**ED055 BEND LONG TAIL**

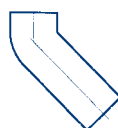

C3401113 - 100 x 45°

**ED006 BRANCH SINGLE**

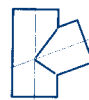

C3401114 - 100 x 100 x 69°  
C3420010 - 150 x 100 x 69°

**ED006 BRANCH SINGLE**

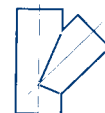

C3401115 - 100 x 100 x 45°  
C3420011 - 150 x 100 x 45°  
C3420012 - 150 x 150 x 45°

**ED06R BRANCH SINGLE (RADIUS)**



C3401116 - 100 x 100 x 88°  
C3420013 - 150 x 100 x 88°  
C3420014 - 150 x 150 x 88°

**ED07R BRANCH SINGLE (RAD.ACCESS)**



C3401117 - 100 x 100 x 88°  
C3420015 - 150 x 100 x 88°  
C3420016 - 150 x 150 x 88°

**ED010 BRANCH DOUBLE**



C3401118 - 100 x 100 x 69°

**ED010 BRANCH DOUBLE**

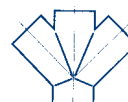

C3401119 - 100 x 100 x 45°  
C3420017 - 150 x 100 x 45°  
C3420018 - 150 x 150 x 45°

**ED010R BRANCH DOUBLE (RADIUS)**

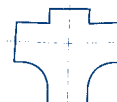

C3401120 - 100 x 100 x 88°  
C3420019 - 150 x 100 x 88°

**ED014 PIPE ACCESS (ROUND ACCESS)**



C3401121 - 100mm  
C3420020 - 150mm

**ED015 PIPE ACCESS (RECT.ACCESS)**



C3401122 - 100mm  
C3420021 - 150mm

**ED028 PIPE TAPER**



C3420022 - 150 x 100mm

**ED034 'P' TRAP PLAIN**



C3401123 - 100mm

## Ensign Drainage System

### ED037 'P' TRAP ACCESS BOTTOM



C3401124 - 100mm  
C3420023 - 150mm

(Supplied with support lug)

### ED074 EXPANSION PLUG

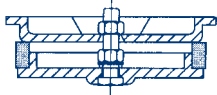

C3401125 - 100mm  
C3420024 - 150mm

### ED070 BLANK END (PLAIN)



C3401125 - 100mm  
C3420025 - 150mm

### ED071 BLANK END (DRILLED & TAPPED)



C3401127 - 100mm x 2"  
C3420026 - 150mm x 2"

### ED060 BELLMOUTH GULLY INLET



C3401128 - 100mm  
Body Only  
C3401129 - 100mm  
(Fitted with  
Sealing Plate  
Grey Only)

### ED060 RAISING PIECE

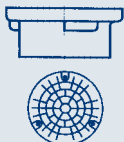

C3401130 - 150mm  
Body Only  
C3401131 - 150mm  
(Fitted with  
Sealing Plate  
Grey Only)

### ED064 GRATING

(TO SUIT BELLMOUTH/RAISING  
PIECE)



C3401132 - 200mm  
Notched (Grey only)

### ED065 GRATING

(TO SUIT BELLMOUTH/RAISING  
PIECE)



C3401133 - 200mm  
Grating (Grey only)

### ED078 PUDDLE FLANGE

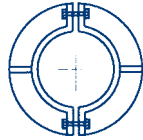

C3401134 - 100mm  
(Grey only)  
C3420027 - 150mm  
(Grey only)

### ED004 PUSH-FIT DRAIN SOCKET



C3401154 - 100mm  
C3420028 - 150mm

### ED076 CONNECTOR



(ENSIGN TO SUPERSLEVE)  
C3401136 - 100mm  
C3420029 - 150mm

### ED012 INSPECTION CHAMBER

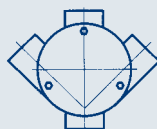

C3401137  
100 x 100 x 45°  
C3420030  
150 x 100 x 45°  
C3420031  
150 x 150 x 45°

## Terrain Soil System

### SOIL SYSTEM 100

UPVC Solvent Weld system to  
BS.4514:69  
Colour: Grey

### 100 SOIL PIPE



High temperature MUPVC  
Plain ends

C3500001 - 75mm x 3m  
Ref: 100.3.30  
C3500011 - 75mm x 4m  
Ref: 100.3.40  
C3500021 - 100mm x 3m  
Ref: 100.4.30  
C3500031 - 100mm x 4m  
Ref: 100.4.40  
C3500041 - 150mm x 3m  
Ref: 100.6.30  
C3500051 - 150mm x 4m  
Ref: 100.6.40

### 101 SWEEP BEND



C3500501  
75mm x 92.5°  
Ref: 101.3.92  
C3500511  
75mm x 135°  
Ref: 101.3.135  
C3500521  
100mm x 92.5°  
Ref: 101.4.92  
C3500531  
100mm x 104°  
Ref: 101.4.104  
C3500541  
100mm x 112.5°  
Ref: 101.4.112  
C3500551  
100mm x 135°  
Ref: 101.4.135  
C3500561  
150mm x 92.5°  
Ref: 101.6.92  
C3500571  
150mm x 135°  
Ref: 101.6.135

### 101 VARIABLE BEND



C3501001  
Spigot to Spigot  
100mm Angle 0.25°  
Ref: 101.4.025

### 102 W.C. CONNECTING BEND



C3501501  
Colour: White  
100mm Angle 92.5°  
Ref: 102.4.5

### 103 ACCESS BEND



C3502001  
100mm Angle 92.5°  
Ref: 103.4.92

### 104 SINGLE BRANCH



C3502501  
Size: 75mm x 92.5°  
Ref: 104.3.92  
C3502511  
Size: 75mm x 135°  
Ref: 104.3.135  
C3502521  
Size: 100mm x 92.5°  
Ref: 104.4.92  
C3502531  
Size: 100mm x 104°  
Ref: 104.4.104  
C3502541  
Size: 100mm x 135°  
Ref: 104.4.135  
C3502551  
Size: 100mm x 92.5°  
(4 Bosses)  
Re: 104.4.924



C3503001  
Size: 150 x 100mm x 92.5°  
Ref: 104.64.92  
C3503011  
Size: 150 x 100mm x 104°  
Ref: 104.64.104  
C3503021  
Size: 150 x 100mm x 135°  
Ref: 104.64.135  
C3503031  
Size: 150mm x 92.5°  
Ref: 104.6.92  
C3503041  
Size: 150mm x 135°  
Ref: 104.6.135

### 104 VARIABLE BOSS BRANCH

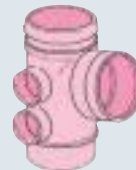

C3503501  
Size: 100mm x 92.5°  
Ref: 104.104.92

**Terrain Soil System**

**105 ACCESS SINGLE BRANCH**



C3504001  
Size: 100mm x 92.5°  
Ref: 105.4.92

**106 DOUBLE BRANCH**



C3504501  
Size: 100mm x 92.5°  
Ref: 106.4.92  
C3504511  
Size: 100mm x 104°  
Ref: 106.4.104  
C3504521  
Size: 100mm x 135°  
Ref: 106.4.135  
C3504531  
Size: 150 x 100mm x 92.5°  
Ref: 106.64.92

**107 SPIGOT SOCKET BEND**



C3505001  
Size: 75mm x 92.5°  
Ref: 107.3.92  
C3505011  
Size: 100mm x 92.5°  
Ref: 107.4.92  
C3505021  
Size: 100mm x 135°  
Ref: 107.4.135  
C3505031  
Size: 150mm x 135°  
Ref: 107.6.135

**107 VARIABLE BEND**



C3505501  
Spigot/Socket  
Variable Between 0 to 25°  
Lockable  
Size: 100mm  
Ref: 107.4.025

**109 SEAL RING ADAPTOR**



C3506001 - Size: 75mm  
Ref: 109.3  
C3506011 - Size: 100mm  
Ref: 109.4  
C3506021 - Size: 150mm  
Ref: 109.6

**110 STRAIGHT COUPLING**



C3506501 - Size: 75mm  
Ref: 110.3  
C3506511 - Size: 100mm  
Ref: 110.4  
C3506521 - Size: 150mm  
Ref: 110.6

**111 STRAIGHT COUPLING EXPANSION**



C3507001 - Size: 75mm  
Ref: 111.3  
C3507011 - Size: 100mm  
Ref: 111.4  
C3507021 - Size: 150mm  
Ref: 111.6

**111A ACCESS COUPLING**



C3507511 - Size: 100mm  
Ref: 111.A4

**111S SLIP COUPLING**



C3508001 - Size: 75mm  
Ref: 111.S3  
C3508011 - Size: 100mm  
Ref: 111.S4  
C3508021 - Size: 150mm  
Ref: 111.S6

**112 BOSS CONNECTOR**

For high temperature  
MUPVC waste



C3508501  
Size: 75 x 32mm  
Ref: 112.3.125  
C3508511  
Size: 75 x 38mm  
Ref: 112.3.15  
C3508521  
Size: 100 x 32mm  
Ref: 112.4.125  
C3508531  
Size: 100 x 38mm  
Ref: 112.3.15  
C3508541  
Size: 100 x 50mm  
Ref: 112.4.2  
C3508551  
Size: 150 x 32mm  
Ref: 112.6.15  
C3508561  
Size: 150 x 38mm  
Ref: 112.6.15  
C3508571  
Size: 150 x 50mm  
Ref: 112.6.2.

**115 SPIGOT BOSS**

C3509501 - Size: 100mm  
Ref: 115.4  
C3509511 - Size: 150mm  
Ref: 115.6

**117 BRANCH BOSS**



C3510001 - Size: 32mm  
Ref: 117.125  
C3510011 - Size: 38mm  
Ref: 117.15  
C3510021 - Size: 50mm  
Ref: 117.2

**117.90 BRANCH BOSS BENT**



C3510501 - Size: 38mm  
Ref: 117.125.90  
C3510521 - Size: 50mm  
Ref: 117.2.90

**120 BOSSED PIPE CONNECTOR**



Solvent weld sockets

C3511001  
Size: 100 x 32mm  
Ref: 120.4.125  
C3511011  
Size: 100 x 38mm  
Ref: 120.4.15

**121 THREE BOSS PIPE CONNECTOR**



C3511051  
Size: 100 x 38mm  
Ref: 121.4.15

**122 SELF LOCKING BOSS**

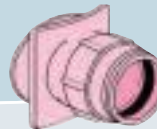

C3511501  
Size: 100 x 32mm  
Ref: 122.4.125  
C3511511  
Size: 100 x 38mm  
Ref: 122.4.15  
C3511521  
Size: 100 x 50mm  
Ref: 122.4.2

**123 BOSSED PIPE CONNECTOR**



Spigot boss and solvent weld sockets

C3512001 - Size: 100mm  
Ref: 123.4

**124 SOCKET REDUCER**



C3512501  
Size: 75 x 50mm  
Ref: 124.3.2  
C3512511  
Size: 100 x 50mm  
Ref: 124.4.2  
C3512521  
Size: 100 x 75mm  
Ref: 125.4.3  
C3512531  
Size: 150 x 100mm  
Ref: 124.6.4

**125 W.C. CONNECTOR**



C3513001 - Size: 100mm  
Colour White  
Ref: 125.4.5

**126 POST FORMED SOCKET**



C3513501  
300mm in Length  
Size: 75mm  
Ref: 126.3.12  
C3513511  
300mm in Length  
Size: 100mm  
Ref: 126.4.12  
C3513521  
300mm in Length  
Size: 150mm  
Ref: 126.6.12

**128 W.C. CONNECTOR**



For 85.5503 closet

C3514001  
Size: 100mm x 2.5°  
Ref: 128.4.02  
Colour White  
C3514011  
Size: 100mm x 90°  
Ref: 128.4.90  
Colour White

## Terrain Soil System

### 130 SOCKET PLUG



- C3515001 - Size: 75mm Ref: 130.3
- C3515011 - Size: 100mm Ref: 130.4
- C3515021 - Size: 150mm Ref: 130.6

### 136 ACCESS CAP



- C3518501 - Size: 75mm Ref: 136.3
- C3518511 - Size: 100mm Ref: 136.4

### 143 HOLDERBAT PLASTIC



- C3522001 - Size: 75mm Ref: 143.3
- C3522011 - Size: 100mm Ref: 143.4

### 131 WEATHERING APRON



#### TO LEAD SLATES

- C3515501 - Size: 75mm Ref: 131.3
- C3515511 - Size: 100mm Ref: 131.4
- C3515521 - Size: 150mm Ref: 131.6

### 137 ACCESS PIPE CONNECTOR



- C3519001 - Size: 75mm Ref: 137.3
- C3519011 - Size: 100mm Ref: 137.4

### 149 WEATHERING SLATE



Base plate: aluminium cone: heat resistant rubber

- C3522501 - Flat Roof 75 - 100mm Dia Ref: 149.16.00
- C3522511 - Pitched Roof 75 - 100mm Dia Ref: 149.18.22
- C3522521 - Pitched Roof 75 - 100mm Dia Ref: 149.24.22

### 131 WEATHERING APRON



#### TO ASPHALT UPSTANDS

- C3516001 - Size: 75mm Ref: 131.3.200
- C3516011 - Size: 100mm Ref: 131.4.200

### 138 ACCESS PIPE



- C3519501 - Size: 100mm Ref: 138.4

### 150 VENT COWL



- C3523001 - Size: 75mm Ref: 150.3
- C3523011 - Size: 100mm Ref: 150.4
- C3523021 - Size: 150mm Ref: 150.6

### 139 ACCESS PIPE



- Spigot/Socket C3520001 - 100mm Ref: 139.4

### 153 AUTOMATIC AIR ADMITTANCE VALVE



- C3523511 - Size: 75/100mm Ref: 153.3.4

### 132 PVC CAULKING BUSH



- C3516501 - Size: 75mm Ref: 132.3
- C3516501 - Size: 100mm Ref: 132.4

### 140 HOLDERBAT SCREW TO WALL

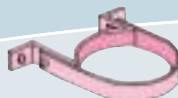

- Galvanized steel C3520501 - Size: 75mm Ref: 140.3
- C3520511 - Size: 100mm Ref: 140.4
- C3520521 - Size: 150mm Ref: 140.6

### 190 THERMAL MOVEMENT LINER



- C3524501 - Size: 100mm Ref: 190.4
- C3524511 - Size: 150mm Ref: 190.6

### 134 CAULKING RING

- C3517501 - Size: 100mm Ref: 134.4
- C3517511 - Size: 150mm Ref: 134.6

### 135 ACCESS DOOR



- C3518001 - Size: 75mm Ref: 135.3
- C3518011 - Size: 100mm Ref: 135.4
- C3518021 - Size: 150mm Ref: 135.6

### 142 HOLDERBAT DRIVE-IN



- Galvanized steel C3521501 - Size: 100mm Ref: 142.4

### 191 INTERMEDIATE SUPPORT



- To be used in conjunction with ref: 190
- C3525001 - Size: 100mm Ref: 191.4
- C3525011 - Size: 150mm Ref: 191.6

## Waste

### WASTE SYSTEM 200

MUPVC Waste pipes and fittings to BS.5255 Colour Grey

### 200 WASTE PIPE



High temperature MUPVC Plain ends

- C3540001 - Size: 32mm x 4m Ref: 200.15.40
- C3540011 - Size: 38mm x 4m Ref: 200.15.40
- C3540021 - Size: 50mm x 4m Ref: 200.2.40

### 201 SWEEP BEND

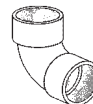

- C3540501 - Size: 32mm x 91° Ref: 201.125.91
- C3540502 - Size: 32mm x 135° Ref: 201.125.135
- C3540503 - Size: 32mm x 165° Ref: 201.125.165

- C3540511 - Size: 38mm x 91° Ref: 201.15.91
- C3540512 - Size: 38mm x 135° Ref: 201.15.135
- C3540513 - Size: 38mm x 165° Ref: 201.15.165

- C3540521 - Size: 50mm x 91° Ref: 201.2.91
- C3540522 - Size: 50mm x 135° Ref: 201.2.135
- C3540523 - Size: 50mm x 165° Ref: 201.2.165

### 204 SWEEP TEE

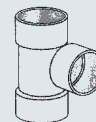

- C3541001 - Size: 32mm x 91° Ref: 204.125.91
- C3541002 - Size: 32mm x 135° Ref: 204.125.135

- C3541011 - Size: 38mm x 91° Ref: 204.15.91
- C3541012 - Size: 38mm x 135° Ref: 204.15.135

- C3541021 - Size: 50mm x 91° Ref: 204.2.91
- C3541022 - Size: 50mm x 135° Ref: 204.2.135



**Terrain Waste System**

**206 SWEEP CROSS**

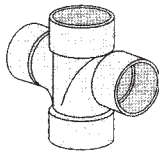

C3541501  
Size: 38mm x 91°  
Ref: 206.15.91  
C3541511  
Size: 50mm x 91°  
Ref: 206.2.91  
C3541521  
Size: 50mm x 135°  
Ref: 206.2.135

**207 SPIGOT/SOCKET BEND**

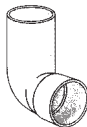

C3542001  
Size: 32mm x 92.5°  
Ref: 206.125.92  
C3542011  
Size: 38mm x 92.5°  
Ref: 206.15.92  
C3542021  
Size: 50mm x 92.5°  
Ref: 206.2.92

**209 SEAL RING ADAPTOR**



C3542501 - Size: 50mm  
Ref: 209.2

**210 STRAIGHT COUPLING**



C3543001 - Size: 32mm  
Ref: 210.125  
C3543011 - Size: 38mm  
Ref: 210.15  
C3543021 - Size: 50mm  
Ref: 210.2

**211 UNION**



C3543501 - Size: 32mm  
Ref: 211.125  
C3543511 - Size: 38mm  
Ref: 211.15  
C3543521 - Size: 50mm  
Ref: 211.2

**212 COUPLING FEMALE IRON TO MUPVC**

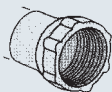

C3544001 - Size: 32mm  
Ref: 212.125  
C3544011 - Size: 38mm  
Ref: 212.15  
C3544021 - Size: 50mm  
Ref: 212.2

**213 COUPLING MALE IRON TO MUPVC**



C3544501 - Size: 32mm  
Ref: 213.125  
C3544511 - Size: 38mm  
Ref: 213.15  
C3544521 - Size: 50mm  
Ref: 213.2

**216 COUPLING FEMALE IRON TO MALE PVC**



High temperature  
C3545501 - Size: 32mm  
Ref: 216.125  
C3545511 - Size: 38mm  
Ref: 216.15  
C3545521 - Size: 50mm  
Ref: 216.2

**217 COUPLING MALE IRON TO MALE PVC**

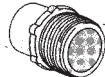

C3546001 - Size: 32mm  
Ref: 217.125  
C3546011 - Size: 38mm  
Ref: 217.15  
C3546021 - Size: 50mm  
Ref: 217.2

**218 REVERSE NUT**

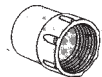

Solvent weld to MUPVC adaptor  
C3546501 - Size: 32mm  
Ref: 218.125  
C3546511 - Size: 38mm  
Ref: 218.15

**223 LEVEL INVERT TAPER**

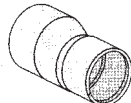

C3547501  
Size: 38 x 32mm  
Ref: 223.15.125  
C3547511  
Size: 50 x 32mm  
Ref: 223.2.125  
C3547521  
Size: 50 x 38mm  
Ref: 223.2.15

**224 LEVEL INVERT SOCKET REDUCER**



C3548001  
Size: 38 x 32mm  
Ref: 224.15.125  
C3548011  
Size: 50 x 32mm  
Ref: 224.2.125  
C3548021  
Size: 50 x 38mm  
Ref: 224.2.15

**225 EXPANSION COUPLING**



C3548501 - Size: 32mm  
Ref: 225.125  
C3548511 - Size: 38mm  
Ref: 225.15  
C3548521 - Size: 50mm  
Ref: 225.2

**226 POST FORMED SOCKET**



C3549001 - Size: 50mm  
Ref: 226.2

**227 COUPLING SPIGOT/SOCKET**



C3549501 - Size: 32mm  
Ref: 227.125  
C3549511 - Size: 38mm  
Ref: 227.15  
C3549521 - Size: 50mm  
Ref: 227.2

**232 UNIVERSAL CAULKING BUSH**

C3550001  
Size: 32/38/50mm  
Ref: 232

**237 ACCESS PLUG**



C3550501 - Size: 32mm  
Ref: 237.125  
C3550511 - Size: 38mm  
Ref: 237.15  
C3550521 - Size: 50mm  
Ref: 237.2

**240 PIPE FIXING CLIP**

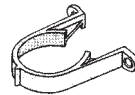

C3551001 - Size: 32mm  
Ref: 240.125  
C3551011 - Size: 38mm  
Ref: 240.15  
C3551021 - Size: 50mm  
Ref: 240.2

**242 FITTING FIXING CLIP**



C3551501 - Size: 32mm  
Ref: 242.125  
C3551511 - Size: 38mm  
Ref: 242.15  
C3551521 - Size: 50mm  
Ref: 242.2

**243 SCREW TO WALL BRACKET**



Zinc plated steel  
C3552001 - Size: 32mm  
Ref: 243.125  
C3552011 - Size: 38mm  
Ref: 243.15  
C3552021 - Size: 50mm  
Ref: 243.2

**250 VENT COWL**

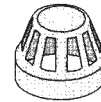

C3552501 - Size: 50mm  
Ref: 250.2

**281 TRAPPED FLOOR GULLY**

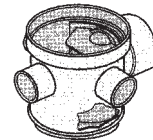

C3553001 - Size: 50mm  
Ref: 281.43  
C3553011 - Size: 75mm  
Ref: 281.64

**OVERFLOW SYSTEM 500**

**500 OVERFLOW PIPE**



C3560001  
Size: 20mm x 4m  
Ref: 500.75.40  
Colour White

**501 BEND**



C3560501  
Size: 20mm x 91°  
Ref: 501.75.91  
C3560511  
Size: 20mm x 135°  
Ref: 501.75.135

**502 BENT TANK CONNECTOR**



C3561001  
Size: 20mm x 91°  
Ref: 501.75.90

## Overflow

Terrain Overflow System  
Continued

### 504 BRANCH



C3561501  
Size: 20mm x 91°  
Ref: 504.75.91

### 510 STRAIGHT COUPLING

C3562001 - Size: 20mm  
Ref: 510.75

### 511 STRAIGHT TANK CONNECTOR

C3562501 - Size: 20mm  
Ref: 511.75

### 512 CONNECTOR FEMALE IRON TO UPVC

C3563001 - Size: 20mm  
Ref: 512.75

### 514 PLAIN NUT

C3563501 - Size: 20mm  
Ref: 514.75

### 540 PIPE CLIP

C3564001 - Size: 20mm  
Ref: 540.75

### 9100 SOLVENT CEMENT



For Soil and Waste Systems

C3590001 - 30ml Tube  
Ref: 9100.030  
C3590011 - 125ml Tin  
Ref: 9100.125  
C3590021 - 250ml Tin  
Ref: 9100.250

### 9101 CLEANING FLUID



For all systems

C3590501 - 125ml Tin  
Ref: 9101.125  
C3590511 - 250ml Tin  
Ref: 9101.250

### 9136 LUBRICANT



For seal ring assembly

C3591001 - 50ml Tube  
Ref: 9136.50  
C3591011 - 250ml Tub  
Ref: 9136.250

## Terrain Rainwater System

### RAINWATER SYSTEM 2100

Half round section UPVC to BS 4576  
Colour stocked: Black  
Grey available to order

### 2100 RAINWATER PIPE



C3700001  
Size: 65mm x 2.5mm  
Ref: 2100.25.25  
C3700011  
Size: 65mm x 3mm  
Ref: 2100.25.30  
C3700021  
Size: 65mm x 4mm  
Ref: 2100.25.40  
C3700031  
Size: 65mm x 5.5mm  
Ref: 2100.25.55

### 2107 CONNECTOR



C3700501 - Ref: 2107.25

### 2108 BEND



C3701001 - 92.5°  
Ref: 2108.25.92  
C3701002 - 112.5°  
Ref: 2108.25.112

### 2109 BRANCH

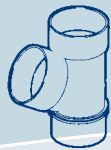

C3701501 - 112.5°  
Ref: 2109.25.112

### 2110 SHOE



C3702001 - Ref: 2110.25

### 2111 RAINWATER HEAD

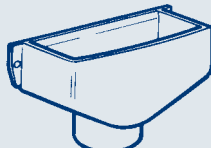

C3702501 - Ref: 2111.25

### 2112 ADJUSTABLE PIPE AND FITTING CLIP

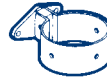

Screw to wall pattern  
C3703001  
Ref: 2112.25.T

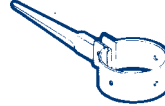

Drive in pattern  
C3703501  
Ref: 2112.25.D

### 2113 PIPE AND FITTING CLIP



C3704001  
Ref: 2113.25

### 2137 RAINWATER ACCESS PIPE



C3704501  
Ref: 2137.25

### 2150 GUTTER

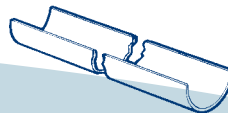

C3705001  
100mm x 4mm  
Ref: 2150.4.40

### 2151 JOINT BRACKET



C3705501 - 100mm  
Ref: 2151.4

### 2152 SUPPORT BRACKET

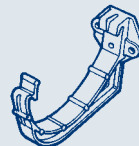

C3706001 - 100mm  
Ref: 2152.4

### 2153 RUNNING OUTLET

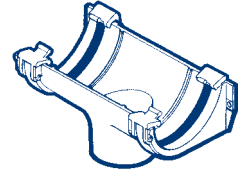

C3706501 - 100mm  
Ref: 2153.4.25

### 2154 GUTTER ANGLE

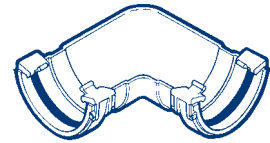

C3707001 - 90°  
Ref: 2154.4.90  
C3707011 - 135°  
Ref: 2154.4.135  
C3707021 - 120°  
Ref: 2154.4.120

### 2155 SHORT STOPEND



C3707501 - Ref: 2155.4

### 2157 STOPEND OUTLET



C3708501  
Ref: 2157.4.25

### 2158 GUTTER ADAPTOR

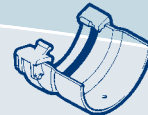

PVC to 115mm cast iron half round spigot UPVC

C3709001  
Ref: 2158.4.45

### 2159 GUTTER ADAPTOR



PVC to 115mm cast iron half round spigot UPVC

C3709011  
Ref: 2159.4.43

## Rainwater

### 2160 ADJUSTABLE RAFTER BRACKET

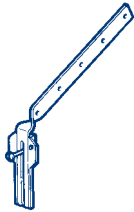

Side Fixing

C3710001 - Ref: 2160

### 2161 ADJUSTABLE RAFTER BRACKET

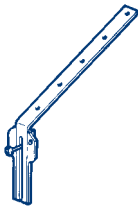

Top Fixing

C3710501 - Ref: 2161

### 2162 RISE AND FALL BRACKET

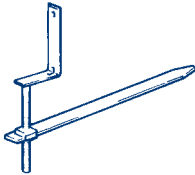

Galvanized Finish

C3711011 - Ref: 2162

### 2168 GUTTER ADAPTOR

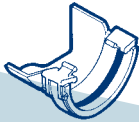

Half round PVC to 115mm cast iron O.G. spigot

C3711501  
Ref: 2168.4.45

### 2169 GUTTER ADAPTOR



Half round PVC to 115mm cast iron O.G. socket

C3712001  
Ref: 2169.4.45

## Sundries

### PLASTIC COATED BALLOON

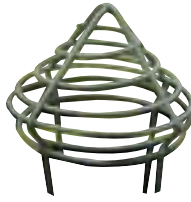

Prevents blockages from leaves, debris and birds nesting in chimneys and down pipes.

C3285551 - 50mm  
C3285561 - 75mm  
C3285571 - 100mm

### LEAD FLASHING

Code 4 - 6 Meter Roll



C3286001 - 150mm wide  
C3286011 - 225mm wide  
C3286021 - 300mm wide

### ALUMINIUM FRESH AIR INLET

80mm inserts into spigot of 100mm pipe



C3287001

### DRAIN TRACING DYE 80z



C3287501 - Blue  
C3287511 - Green  
C3287521 - Red  
C3287531 - Yellow  
C3287541 - Fluorescein

### PC4AF COLD CAULKING

Caulking cord for jointing conventional soil pipes



C3061503 - 3kg Tub

### C.I. COAL PLATES AND FRAMES

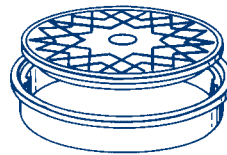

C4004500  
356mm Dia  
Depth 64mm

C4004501  
305mm Dia  
Depth 57mm

### FLEXIBLE RUBBER COUPLINGS PLASTIC TO PLASTIC



C3283011 - 100mm  
C5031018 - 32mm  
C5031019 - 38mm  
C5031017 - 50mm  
C5031016 - 75mm  
C5031015 - 75 x50mm  
C5031014 - 100 x75mm

### CLAY TO CAST IRON OR PLASTIC



C3283001 - 100mm

### FLEXIBLE RUBBER CAPS



C9920081 - 50mm  
C9920082 - 75mm  
C9920083 - 100mm

### PLASTIC STRAP ON BOSS

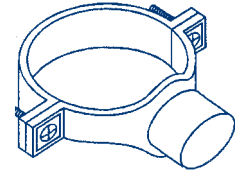

C3283501  
100mm with 50mm Boss

### AIR ADMITTANCE VALVE WHITE

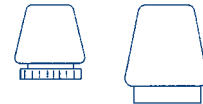

C3284001 - 38mm  
C4080011 - 50mm

### CAROFLOW ROOF OUTLETS TO ORDER



# N&C

## Glass

Glass

### Manufacturing

#### MANUFACTURING AND SUPPLY OF:

- Shopfronts
- Toughened glass
- Sealed units
- Mirrors
- Bevelled, curved, drilled, polished glass
- Sand blasting
- Glass and glazing products
- Research and development in the latest technical equipment
- Manufacturing and distribution centre
- Document L compliance



### Supply

#### SUPPLIERS OF:

- Solar & environmental glass
- Bullet resistant glass
- Coloured glass
- Curved glass
- Security glass
- Laminated safety glass
- Patterned glass
- Fire resistant glass
- Sand blasted glass
- Mirrors



#### STOCKED MIRRORS (SUPPLIED IN PACKS OF FIVE)

- S2000301 - 4mm P.A.R Mirror 457 x 305mm (Drilled 2)
- S2000302 - 4mm P.A.R Mirror 610 x 457mm (Drilled 4)
- S2000303 - 4mm P.A.R Mirror 610 x 610mm (Drilled 4)
- S2000304 - 4mm Bevelled Mirror 457 x 305mm (Drilled 2)
- S2000305 - 4mm Bevelled Mirror 610 x 457mm (Drilled 4)
- S2000306 - 4mm Bevelled Mirror 610 x 610mm (Drilled 4)

Please Contact Our Sales Department For Further Information on Processed Glass

Glass Manufacturing





**N&C**  
*Olympus*

# Home Style

## Range

Compiled with domestic and new build projects in mind this range of classic door furniture and accessories offers an affordable choice of styles and finishes.

Victorian Polished Brass

Brass Range

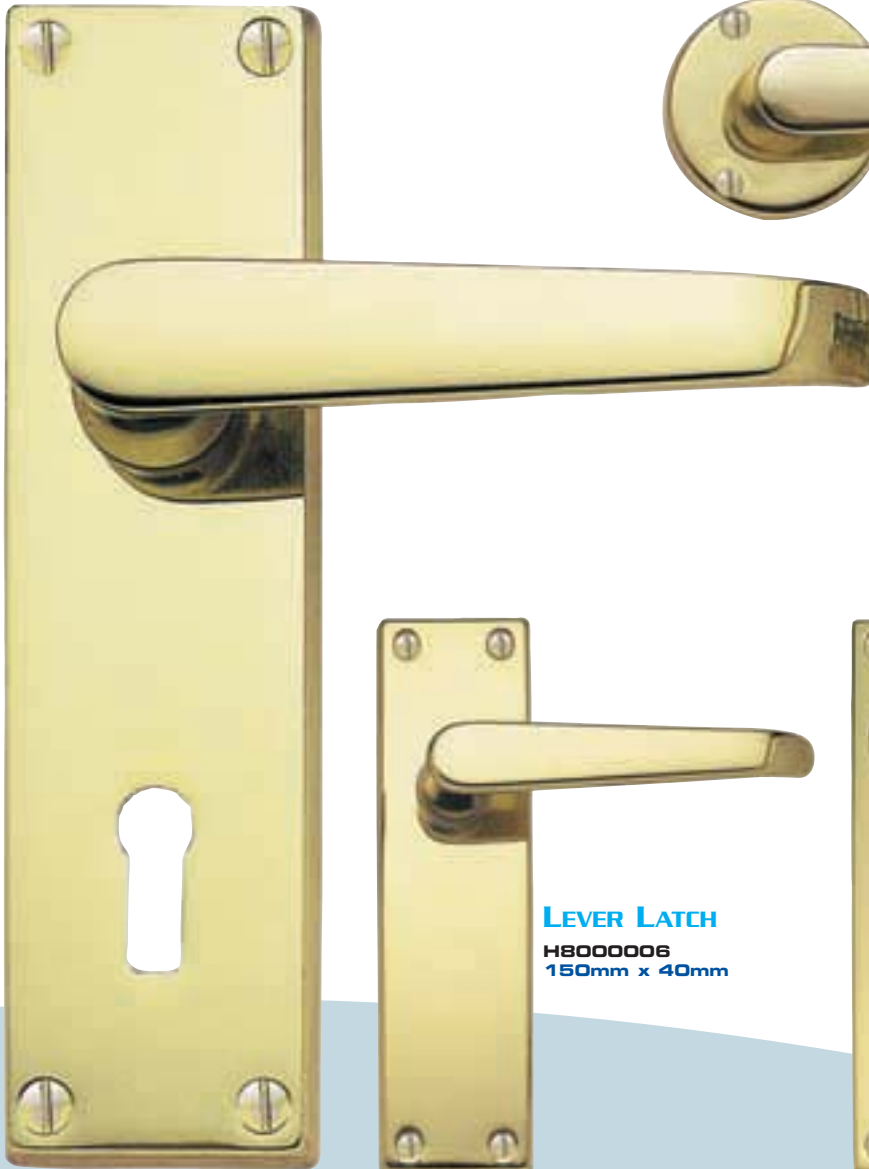

**LEVER LOCK**  
H8000001 - 150mm x 40mm  
Also available: Oval & Euro Cut out



**LEVER ON ROSE**  
H8000003 - 60mm Rose



**LEVER LATCH**  
H8000006  
150mm x 40mm



**BATHROOM SET**  
H8000004  
150mm x 40mm



**LEVER LATCH**  
H8000002  
112mm x 40mm



**PRIVACY SET**  
H8000005  
112mm x 40mm

## Victorian Scroll Polished Brass

# Brass Range



**LEVER ON ROSE**

H8000013 - 60mm Rose



**LEVER LATCH**

H8000016  
150mm x 39mm



**BATHROOM SET**

H8000014  
150mm x 39mm

**LEVER LOCK**

H8000011 - 150mm x 39mm

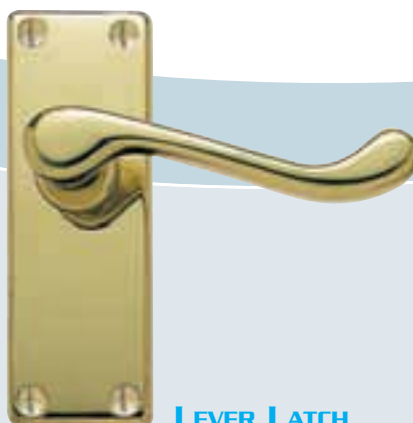

**LEVER LATCH**

H8000012 - 110mm x 39mm



**PRIVACY SET**

H8000015 - 110mm x 39mm

Olympus

**Epsom Suite Polished Brass**



**LEVER LOCK**  
H8000017 · 170mm x 40mm



**LEVER LATCH**  
H8000018 · 170 x 40mm



**BATHROOM SET**  
H8000019 · 170mm x 40mm

Brass Range

**Georgian Suite**



**LEVER LOCK**  
H8000007 · 150mm x 48mm



**LEVER LATCH**  
H8000008 · 150mm x 48mm



**BATHROOM SET**  
H8000009 · 150mm x 48mm



## Mortice & Rim Knob Furniture Polished Brass



### MORTICE KNOB

H8000064 - 50mm  
H8000065 - 57mm  
H8000066 - 64mm  
Contract Version  
H8000068 - 57mm



### OVAL MORTICE KNOB

H8000067 - 60mm



### RIM MORTICE SET

H8000070 - 50mm  
H8000071 - 57mm  
Contract Version  
H8000072 - 57mm



### BALL MORTICE KNOB

H8000069 - 60mm

## Centre Door Knobs Polished Brass



### CENTRE DOOR KNOB

H8000061 - 64mm  
Diameter



### CENTRE DOOR KNOB

H8000062 - 102mm  
Diameter



### CENTRE DOOR KNOB

H8000063 - 67mm  
Diameter

Brass Range

## Polished Brass Escutcheon



### ESCUTCHEON

H8000031 - 35mm Diameter



### COVERED ESCUTCHEON

H8000050 - 32mm  
Diameter

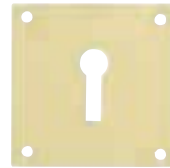

### SQUARE ESCUTCHEON

H8000016 - 50 x 50mm



### OVAL COVERED ESCUTCHEON

H8000036 - 45mm



### COVERED ESCUTCHEON

H8000035 - 32mm



### UNCOVERED ESCUTCHEON

H8000037 - 32mm

Door Furniture Accessories Polished Brass



**RING KNOCKER**  
H8000020 - PB 105mm Diameter



**DOCTOR KNOCKER**  
H8000022 - 152mm



**KNOCKER**  
H8000021 - PB 160mm



**SMALL URN KNOCKER**  
H8000073 - 152mm



**SCROLL KNOCKER**  
H8000074 - 130mm



**CYLINDER PULL**  
H8000075 - 60mm



**CYLINDER PULL**  
H8000023 - PB 60mm



**CIRCULAR BELL PUSH**  
H8000024 - PB 60mm



**BELL PUSH**  
H8000076 - 77mm x 30mm



**NUMERALS 0-9**  
H8012000 to 09 - 75mm screwfix

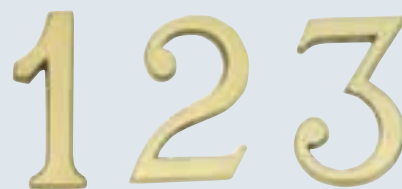

**NUMERALS 0-9**  
H8012100 to 09 - 60mm Pin Fix

Brass Range

## Letter Plates Polished Brass

# Brass Range



**TRINITY LETTER PLATE**

H8000026 - 279mm x 51mm



**PULL HANDLE  
ON POSTAL PLATE**

H8000080 - 250mm x 102mm



**POSTAL KNOCKER**

H8000025 - 250mm x 76mm



**GEORGIAN LETTER PLATE**

H8000082 - 279mm x 89mm



**GEORGIAN POSTAL KNOCKER**

H8000083 - 250mm x 76mm



**LETTER PLATE**

H8000027 - 254mm x 100mm  
H8000077 - 279mm x 89mm  
H8000028 - 300mm x 100mm  
H8000078 - 350mm x 100mm  
H8000079 - 400mm x 100mm



**INNER TIDY**

H8000029 - 280mm (To Suit H8000027)  
H8000030 - 302mm (To Suit H8000028)  
H8000084 - 356mm (To Suit H8000078)  
H8000085 - 400mm (To Suit H8000079)



**GRAVITY PLATE**

H8000081 - 254mm x 76mm

**Pull Handles Polished Brass**

Brass Range



**PULL HANDLE ON PLATE**

H8000086 - 225mm  
 H8000087 - 305mm



**PULL HANDLES**

H8000089 - 152mm  
 H8000090 - 200mm  
 H8000091 - 250mm  
 H8000092 - 300mm



**PULL HANDLE ON PLATE**

H8000095 - 300mm x 63mm



**PULL HANDLE ON PLATE**

H8000096 - 300mm x 75mm



**RAISED FINGER PLATE**

H8000032 - 305mm x 75mm



**CRANKED PULL HANDLE**

H8000093 - 225mm  
 H8000094 - 300mm



**CONCEALED PULL HANDLE**

H8000097 - 225mm  
 H8000098 - 305mm



**BOLT FIX PULL HANDLE**

H8000101 - 225mm  
 H8000102 - 305mm



**PULL HANDLES**

H8000103 - 125mm  
 H8000104 - 175mm  
 H8000105 - 225mm



## Hooks & Hand Rail Brackets Polished Brass

olympus

Brass Range



**HAT & COAT HOOK**  
H8000033 - 125mm



**SINGLE ROBE HOOK**  
H8000034 - 40mm



**SINGLE ROBE HOOK**  
H8000108 - 30mm



**DOUBLE ROBE HOOK**  
H8000099 - 45mm



**DOUBLE ROBE HOOK**  
H8000109 - 40mm

**HAT & COAT HOOK**  
H8000107 - 100mm



**ROBE HOOK**  
H8000111 - 50mm



**HAT & COAT HOOK**  
H8000110 - 130mm



**HANDRAIL BRACKET**  
H8000112 - 65mm



**HANDRAIL BRACKET HEAVY PATTERN**  
H8000113 - 64mm  
H8000114 - 75mm

**Casement Fasteners Polished Brass**



**NIGHT VENT FASTENER**  
H8000121 - 105mm



**HOOK & MORTICE FASTENER**  
H8000120 - 100mm

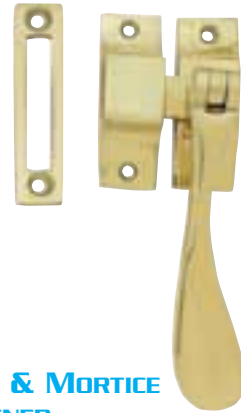

**HOOK & MORTICE FASTENER**  
H8000038 - 100mm



**HOOK & MORTICE FASTENER**  
H8000115 - 100mm



**LOCKING FASTENER**  
H8000116 - 110mm



**HOOK & MORTICE BULB END FASTENER**  
H8000117 - 100mm



**NIGHT VENT FASTENER**  
H8000118 - 110mm



**WEDGE FASTENER**  
H8000119 - 110mm



**FRENCH WIDOW FASTENER**  
H8000122 - 100mm

## Casement Stays Polished Brass



**BULB END STAY**

H8000123 - 250mm  
H8000124 - 300mm



**VICTORIAN STAY**

H8000125 - 200mm  
H8000126 - 250mm  
H8000127 - 300mm



**KIMPTON STAY**

H8000128 - 250mm  
H8000129 - 300mm



**HEAVY STAY**

H8000039 - 250mm  
H8000040 - 300mm



**GEORGIAN STAY**

H8000130 - 250mm  
H8000131 - 300mm

# Brass Range

Olympus

**Window Fasteners and Catches Polished Brass**

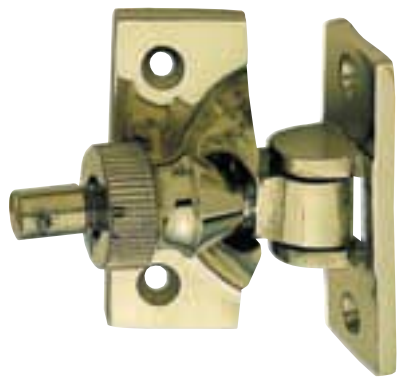

**BRIGHTON FASTENER**  
H8000043



**SASH FASTENER**  
H8000041 - 70mm



**SASH LIFT**  
H8000042 - 50mm

Brass Range



**NARROW FITCH FASTENER**  
H8000132 - 70mm



**NARROW LOCKING FITCH FASTENER**  
H8000133 - 70mm



**FITCH FASTENER**  
H8000044 - 70mm

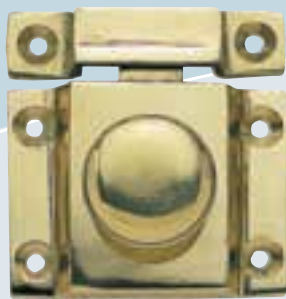

**DOOR CATCH**  
H8000135 - 56mm x 36mm



**FANLIGHT CATCH WITH RING**  
H8000046 - 56mm x 36mm



**FANLIGHT CATCH WITH KNOB**  
H8000134 - 56mm x 36mm

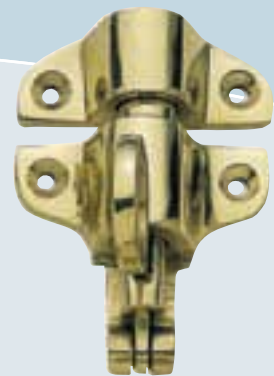

**FANLIGHT CATCH**  
H8000045 - 36mm



## Door Bolts Polished Brass

# Brass Range



**DOOR BOLT**

H8000047 - 63mm x 25mm

**STRAIGHT DOOR BOLT**

H8000138 - 100mm x 32mm  
H8000139 - 150mm x 32mm

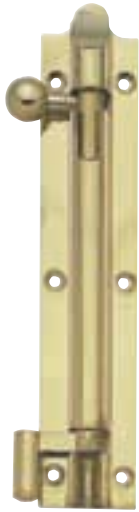
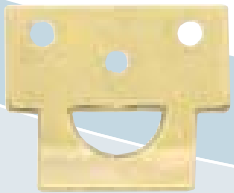

**DOOR BOLT**

H8000136 - 200mm  
H8000137 - 250mm

**NECKED DOOR BOLT**

H8000140 - 100mm x 32mm  
H8000141 - 150mm x 32mm

**DOOR BOLT**

H8000048 - 150mm  
H8000049 - 200mm

**DOOR BOLT**

H8000142 - 250mm  
H8000143 - 300mm  
H8000144 - 350mm  
H8000145 - 400mm  
H8000146 - 500mm  
H8000147 - 600mm

Olympus

**Bathroom Bolts Polished Brass**

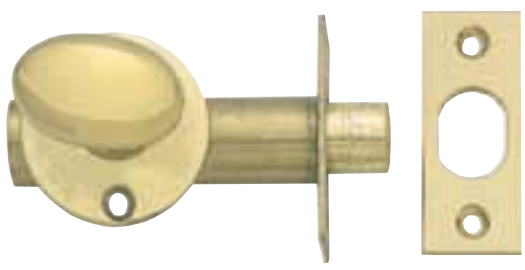

**BATHROOM BOLT**  
H8000052

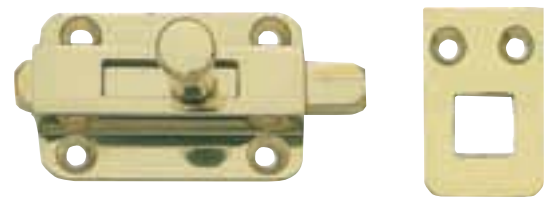

**INDICATOR BOLT**  
H8000149



Brass Range



**5MM BATHROOM TURN & RELEASE**  
H8000056



**TURN KNOB**  
H8000053

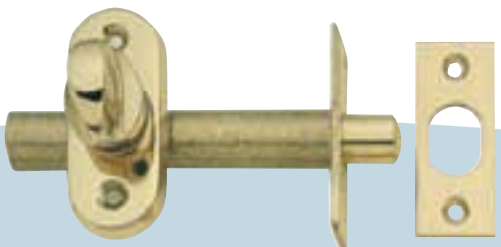

**BATHROOM BOLT**  
H8000148



**DOOR BOLT**  
H8000054

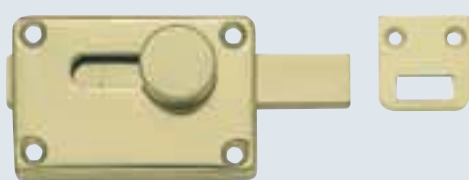

**INDICATOR BOLT**  
H8000167 - Internal 60mm x 40mm  
External 50mm x 50mm



## Accessories Polished Brass

# Brass Range



**SMALL DOOR HOLDER**  
H8000162 - 165mm



**SHOWCASE CATCH**  
H8000051 - 40mm



**THROW OVER CATCH**  
H8000150 - 50mm



**SHELF BRACKET**  
H8000151



**CLEAT HOOK**  
H8000152 - 75mm



**CABIN HOOK**  
H8000153 - 75mm  
H8000154 - 102mm  
H8000155 - 152mm  
H8000156 - 200mm  
H8000157 - 250mm  
H8000158 - 300mm



**DOOR CHAIN**  
H8000060 - 85 x 35mm



**PROJECTING DOOR STOP**  
H8000159 - 64mm  
H8000057 - 75mm



**DOOR STOP**  
H8000160 - 70mm



**SHIELDED DOOR STOP**  
H8000161 - 40 X30mm



**OVAL DOOR STOP**  
H8000058



**EB PROJECTING SPRING DOOR STOP**  
H8000059 - 75mm

Olympus

**Victorian Polished Chrome**

Chrome Range



**LEVER LOCK**

H8001001 - 150mm x 40mm  
Also available: Oval & Euro Cutout



**LEVER ON ROSE**

H8001003 - 60mm Rose



**BATHROOM SET**

H8001004 - 150mm x 40mm



**LEVER LATCH**

H8001002 - 112mm x 40mm



**PRIVACY SET**

H8001005 - 112mm x 40mm



## Victorian Scroll Polished Chrome

olympus

Chrome Range



**LEVER LOCK**  
H8001011 -  
150mm x 39mm



**BATHROOM SET**  
H8001014 - 150mm x 39mm



**PRIVACY SET**  
H8001015 -  
110mm x 39mm



**LEVER LATCH**  
H8001012 - 110mm x 39mm

Olympus

**Epsom Suite Polished Chrome**

Chrome Range



**LEVER LATCH**  
H8001018 - 170mm x 40mm



**LEVER LOCK**  
H8001017 - 170mm x 40mm



**BATHROOM SET**  
H8001019 - 170mm x 40mm

**Mortice Knobs**



**MORTICE KNOB BALL**  
H8001006 - 50MM



**MORTICE KNOB**  
H8001007 - 57MM



**OVAL MORTICE KNOB**  
H8001008 - 57MM

**Door Accessories Polished Chrome**



**RING KNOCKER**  
H8001020 - 105mm



**POLISHED STAINLESS STEEL INNER FLAP**  
H7001027 - 250mm x 76mm



**LETTER PLATE**  
H8001025 - 250mm x 76mm  
H7001026 - 305mm x 102mm



**POSTAL KNOCKER**  
H8001024 - 250mm x 76mm



**CENTRE DOOR KNOB**  
H8001009 - 64mm



**BELL PUSH**  
H8001023 -  
76mm x 25mm



**CYLINDER PULL**  
H8001022 -  
70mm x 45mm



**UNCOVERED ESCUTCHEON**  
H8001031 - 32mm



**COVERED ESCUTCHEON**  
H7001032 - 32mm



**180 DEGREE SPY HOLE VIEWER**  
H8001010



**CODE NUMERALS CP 0-9**  
H8022000 to 09 -  
75mm Screw Fix



**JCP NUMERALS CP 0-9**  
H8022100 to 09 -  
60mm Pin Fix

Chrome Range

**Window Fittings & Bolts Polished Chrome**

Chrome Range



**NARROW LOCKING FITCH FASTENER**  
H8001068



**DRAW PULL**  
H8001015 - 75mm  
H8001016 - 102mm

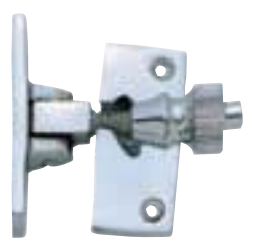

**BRIGHTON FASTENER**  
H8001038 - 55mm



**SASH FASTENER**  
H8001036 - 70mm



**HOOK & MORTICE PLATE FASTENER**  
H8001033 - 105mm



**FITCH FASTENER**  
H8001039 - 65mm



**SASH LIFT**  
H8001037 - 50mm



**BELL BOLTS**  
**Straight**  
H8001054 - 102mm x 32mm  
H8001055 - 150mm x 32mm  
**Necked**  
H8001056 - 102mm x 32mm  
H8001057 - 150mm x 32mm



**STAY**  
H8001034 - 250mm  
H8001035 - 300mm



## Accessories Polished Chrome

olympus

Chrome Range



**Bow Handle**  
H8001058 - 152mm



**SASH HANDLE**  
H8001059 - 102mm  
H8001060 - 125mm  
H8001040 - 152mm



**HAT AND COAT HOOK**  
H8001029 - 125mm



**DOUBLE ROBE HOOK**  
H8001061 - 42mm



**SINGLE ROBE HOOK**  
H8001030 - 50mm



**CABIN HOOK**  
H8001062 - 102mm  
H8001042 - 152mm



**OVAL DOOR STOP**  
H8001049 - 50mm x 40mm



**PROJECTING DOOR STOP**  
H8001048 - 75mm



**PROJECTING SPRING DOOR STOP**  
H8001069 - 75mm



**SHIELDED DOOR STOP**  
H8001063 - 40mm x 30mm



**DOOR CHAIN**  
H8001050 - 85 x 35mm



**SHOW CASE CATCH**  
H8001043 - 50mm



**SHELF FASTENER BRACKET**  
H8001064 - 50mm

**Bathroom Bolts Polished Chrome**

Chrome Range



**BATHROOM BOLT**  
H8001041 - 63 x 25mm



**5MM BATHROOM TURN & RELEASE**  
H8001045



**TURN KNOB**  
H8001070

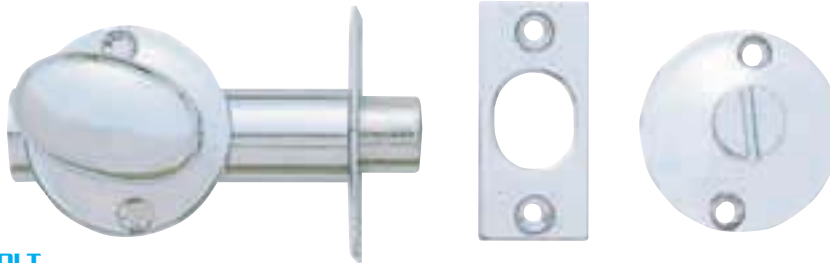

**BATHROOM BOLT**  
H8001044



**INDICATOR BOLT**  
H8001066



**INDICATOR BOLT**  
H8001067 - Internal 60mm x 40mm  
External 50mm x 50mm

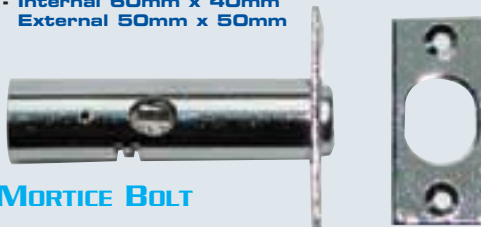

**SECURITY MORTICE BOLT**  
H8001046

## Victorian Satin Chrome

olympus

Chrome Range



**LEVER LOCK**

H8002001 - 150mm x 39mm



**BATHROOM SET**

H8002004 - 150mm x 39mm



**PRIVACY SET**

H8002005 - 110mm x 39mm



**LEVER LATCH**

H8002002 - 110mm x 39mm



**LEVER ON ROSE**

H8002003 - 60mm rose

**Epsom Suite Satin Chrome**

Chrome Range



**LEVER LATCH**  
H8002018 · 170mm x 40mm



**LEVER LOCK**  
H8002017 · 170mm x 40mm



**BATHROOM SET**  
H8002019 · 170mm x 40mm

**Mortice & Rim Knob Furniture Satin Chrome**



**RIM KNOB FURNITURE**  
H8002033 · 57mm



**OVAL MORTICE KNOB**  
H8002007 · 57mm



**MORTICE KNOB**  
H8002006 · 57mm



## Accessories Satin Chrome

olympus



**HAT & COAT HOOK**  
H8002023 - 125mm



**COVERED ESCUTCHEON**  
H8002025 - 32MM



**CYLINDER PULL**  
H8002020 - 70mm



**PROJECTING DOOR STOP**  
H8002031 - 75mm



**INDICATOR BOLT**  
H8002011 - Internal 60mm x 40mm  
External 50mm x 50mm



Chrome Range



**OVAL DOORSTOP**  
H8002032 - 45mm x 50mm



**ROBE HOOK**  
H8002024 - 50mm



**DOUBLE ROBE HOOK**  
H8002010 - 42mm

Olympus

**Accessories Satin Chrome**



**CASEMENT STAY**  
H8002027 - 250mm  
H8002028 - 300mm



**LETTER PLATE**  
H8002021 - 250mm x 75mm  
H8002022 - 305mm x 100mm



**PULL HANDLE**  
H8002008 - 225mm



**BRIGHTON FASTENER**  
H8002034



**FITCH FASTENER**  
H8002035



**NARROW LOCKING FITCH FASTENER**  
H8002036



**REVERSIBLE HOOK & MORTICE PLATE**  
H8002026 - 105mm



**SASH LIFT**  
H8002030 - 50mm



**SASH FASTENER**  
H8002029 - 70mm

Chrome Range

## China Door Furniture



**PLAIN WHITE FINGER PLATE**  
H8050002 - 280mm



**PLAIN WHITE MORTICE KNOB**  
H8050001 - 62mm



**PLAIN WHITE KNOB**  
H8050006 - 49mm



**PLAIN WHITE WARDROBE KNOB**  
H8050004 - 38mm



**PLAIN WHITE CUPBOARD KNOB**  
H8050005 - 30mm



**PLAIN WHITE ESCUTCHEON**  
H8050003 - 60mm



**GOLDLINE FINGER PLATE**  
H8050102 - 280mm



**GOLDLINE WHITE MORTICE**  
H8050101 - 62mm



**GOLDLINE WHITE KNOB**  
H8050106 - 49mm



**GOLDLINE WHITE WARDROBE KNOB**  
H8050104 - 38mm



**GOLDLINE WHITE CUPBOARD KNOB**  
H8050105 - 30mm



**GOLDLINE ESCUTCHEON**  
H8050103 - 60mm

# China Range

ABOVE RANGES ALSO AVAILABLE IN BLACK

**Black Antique Furniture**



**LEVER LOCK SET**

H8070001 - 150 x 50mm



**LEVER LATCH SET**

H8070003 - 150 x 50mm



**BATHROOM LOCK SET**

H8070004 - 150 x 50mm



**LEVER LATCH**

H8070002 - 110 x 50mm

Antique Range



**LEVER LATCH SET**

H8070011 - 195 x 50mm



**LEVER LOCK SET**

H8070012 - 195 x 50mm



**ESCUTCHEON**

H8070023 - 50mm



**FLEUR DE LYS CYLINDER COVER**

H8070021 - 120mm



**BELL PUSH**

H8070022 - 130 x 35mm

## Black Antique Furniture



**LETTERPLATE**

H8070024 - 250 x 75mm



**POSTAL KNOCKER**

H8070025 - 305 x 102mm



**FLEUR DE LYS  
PULL HANDLE**

H8070031 - 170mm



**LION KNOCKER**

H8070020 - 75 x 64mm



**NECKED BOLT**

H8070040 - 200mm



**STRAIGHT BOLT**

H8070041 - 200mm



**FINGERPLATE**

H8070032 - 300 x 70mm

# Antique Range



**Black Antique Furniture**



**INDICATOR BOLT**  
H8070050 - 700mm diameter plate



**CENTRE DOOR KNOB**  
H8070026 - 70mm



**NUMERALS 0-9**  
H8071000 to 09 - 100mm

Antique Range



**HAT & COAT HOOK**  
H8070051 - 160mm



**HAT & COAT HOOK**  
H8070052 - 140mm



**FANCY HINGE**  
H8070037 - 89mm



**DOUBLE ROBE HOOK**  
H8070055 - 50mm



**ROBE HOOK**  
H8070053 - 40mm



**ROBE HOOK**  
H8070054 - 55mm



**CABIN HOOK**  
H8070060 - 102mm  
H8070061 - 152mm

## Black Antique Furniture

# Antique Range



**HINGE**  
H8070035 - 400mm



**HINGE FRONT**  
H8070036 - 400mm



**HOOK & MORTICE  
PLATE FASTENER**  
H8070045 - 75mm

**THUMB LATCH HANDLE**  
H8070030 - 230mm



**CASEMENT STAY**  
H8070046 - 250mm  
H8070047 - 300mm

**Rim Locks**

**CYLINDER RIM NIGHTLATCHES STANDARD STILE**

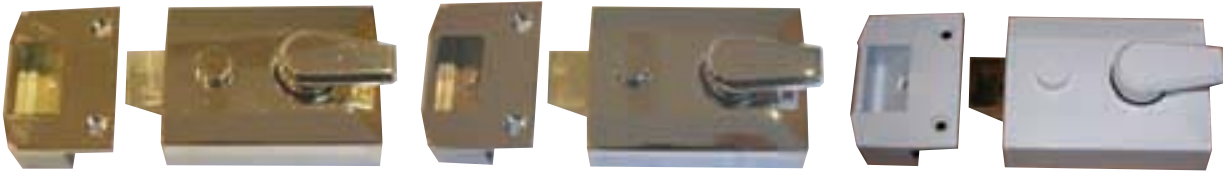

H8010020 - 90mm x 70mm Brass    H8020020 - 90mm x 70mm Chrome    H8010021 - 90mm x 70mm White

**CYLINDER RIM NIGHTLATCHES NARROW STILE**

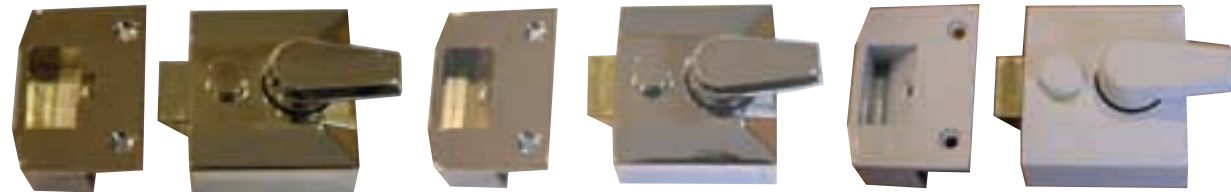

H8010030 - 60mm x 70mm Brass    H8020030 - 60mm x 70mm Chrome    H8010031 - 60mm x 70mm White

Lock Range

**TRADITIONAL NIGHTLATCH**

**RIM CYLINDERS**

**KEY BLANKS**

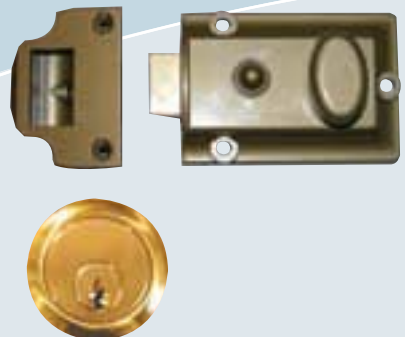

H8010050 - Gold/Brass Cylinder  
 H8020050 - Silver/CP Cylinder  
 H8010060 - PB/Brass Cylinder  
 H8020060 - CP/CP Cylinder



H8010040 - Brass  
 H8020040 - CP



H8010025

**Rim and Mortice Locks**

**RIM LOCK**



152mm x 100mm  
**H8010001 - Polished Brass**  
**H8020001 - Polished Chrome**

**RIM LATCH**



**H8010002 - 100mm x 76mm Polished Brass**

**TUBULAR LATCH**

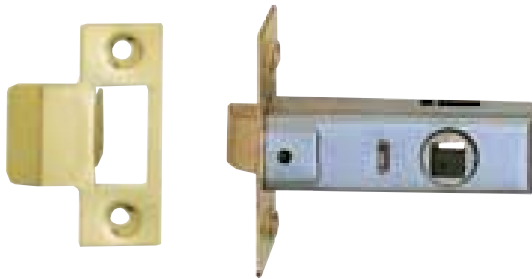

**H0041002 - 64mm Brass**  
**H0041004 - 76mm Brass**  
**H0041001 - 64mm Satin**  
**H0041003 - 76mm Satin**

**DOUBLE SPRING TUBULAR LATCH**

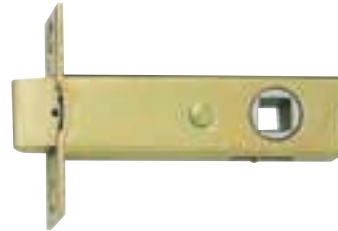

**H8010009 - 100mm Satin Brass**  
**H8010010 - 151mm Satin Brass**  
**H8020009 - 100mm Satin Steel**  
**H8020010 - 151mm Satin Steel**

**ROLLER BOLT CATCH**

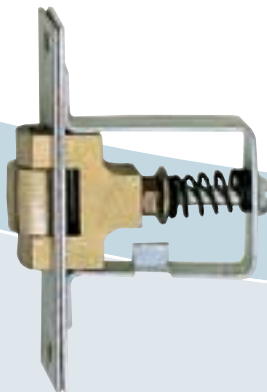

32mm x 45mm  
**H8010018 - Satin Brass**  
**H8020018 - Satin Steel**

**BATHROOM DEADBOLT**



**H8000055 - Brass**  
**H8001047 - Satin Steel**

Lock Range

## Mortice Lock Ranges

### 3 LEVER SASH LOCKS



- H8010005 - 64mm Brass
- H8010006 - 76mm Brass
- H8020005 - 64mm Satin
- H8020006 - 76mm Satin

### 3 LEVER DEAD LOCKS



- H8010011 - 64mm Brass
- H8010012 - 76mm Brass
- H8020011 - 64mm Satin
- H8020012 - 76mm Satin

### BATHROOM LOCKS



- H8010007 - 64mm Brass
- H8010008 - 76mm Brass
- H8020007 - 64mm Satin
- H8020008 - 76mm Satin

### 5 LEVER SASH LOCKS



- H8010013 - 64mm Brass
- H8010014 - 76mm Brass
- H8020013 - 64mm Satin
- H8020014 - 76mm Satin

### 5 LEVER DEAD LOCKS

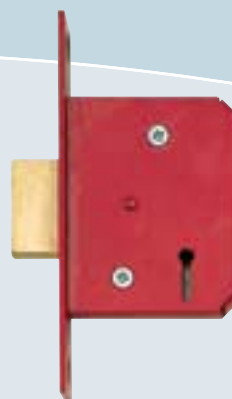

- H8010015 - 64mm Brass
- H8010016 - 76mm Brass
- H8020015 - 64mm Satin
- H8020016 - 76mm Satin



**Hinges**

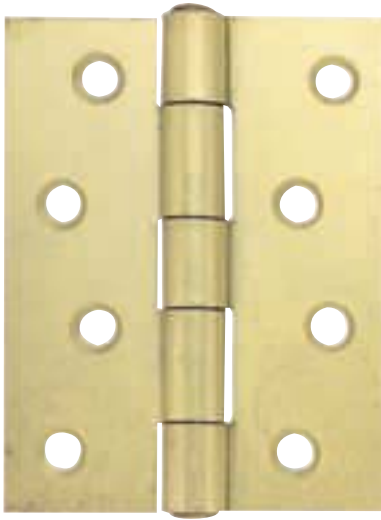

**451 STEEL HINGE**

H8011012 - EB 102 x 75mm  
H8021013 - ZP 102 x 75mm

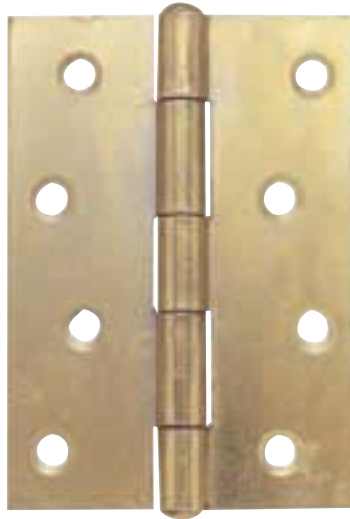

**1838 STEEL HINGE**

H8011015 - EB 75mm  
H8011016 - EB 100mm  
H8021020 - ZP 75mm  
H8021021 - ZP 100mm



**LOOSE PIN HINGE**

H8011019 - EB 75mm  
H8011020 - EB 102mm  
H8021022 - ZP 75mm  
H8021023 - ZP 102mm

Hinges



**BRASS STORM PROOF SINGLE**

H8011005 - 60mm Self Colour



**FLUSH HINGE**

H8011021 - EB 40mm  
H8011022 - EB 50mm  
H8011023 - EB 60mm  
H8011024 - EB 75mm  
H8021014 - ZP 40mm  
H8021015 - ZP 50mm  
H8021016 - ZP 60mm  
H8021017 - ZP 75mm

**Hinges Architectural Quality**

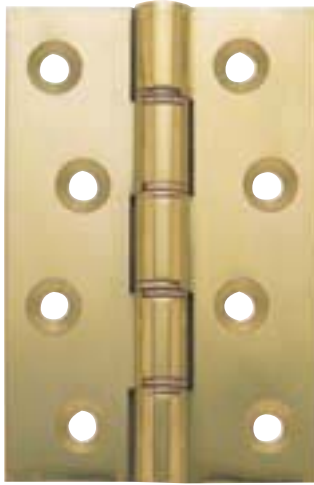

**POLISHED & LACQUERED BRASS  
DPBW**

- H8011002 - 76mm x 50mm x 3mm
- H8011003 - 102mm x 67mm x 3.5mm
- H8011004 - 102mm x 76mm x 3.5mm

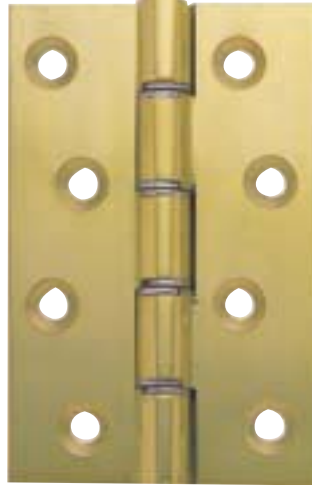

**POLISHED & LACQUERED  
BRASS DSSW**

- H8011026 - 76mm x 50mm x 3mm
- H8011027 - 102mm x 67mm x 3.5mm
- H8011028 - 102mm x 76mm x 3.5mm



**SC BRASS**

- Solid Drawn Standard
- H8011031
- 102mm x 60mm x 3mm
- H8011029
- 76mm x 40mm x 3mm
- H8011030
- 102mm x 76mm x 3.5mm

Hinges

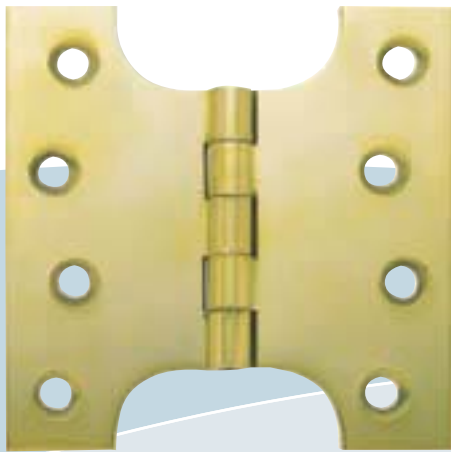

**SOLID DRAWN PARLIAMENT**

**HINGE POL & LAQ**

- H8011009 - 102mm x 102mm x 3mm
- H8011010 - 102mm x 125mm x 3mm
- H8011011 - 102mm x 152mm x 3mm

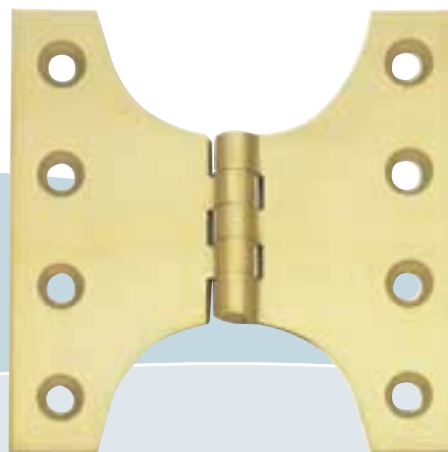

**PARLIAMENT HINGE**

**POL CHROME**

- H8021008 - 102mm x 102mm x 3mm
- H8021009 - 102mm x 125mm
- H8021010 - 102mm x 152mm



**FINIAL HINGE POL & LAQ**

- H8011007 - 102mm x 67mm x 3.5mm
- H8011008 - 102mm x 76mm x 4mm
- H8011006 - 76mm x 50mm x 3mm

**Hinges Stainless Steel Pol Chrome and Aluminium**



**RIISING BUTT HINGE**

- H8021050 - Steel 75mm LH
- H8021060 - Steel 100mm LH
- H8021051 - Steel 75mm RH
- H8021061 - Steel 75mm RH
- H8011050 - EB 75mm LH
- H8011060 - EB 100mm LH
- H8011051 - EB 75mm RH
- H8011061 - EB 100mm RH



**SATIN STAINLESS STEEL WASHERED**

- H8021018 - 102mm x 67mm x 3.5mm

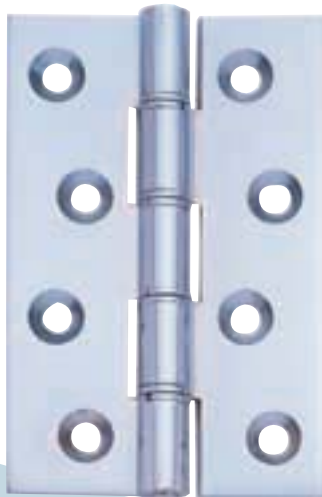

**POLISHED CHROME**

- H8021000 - 76mm x 50mm x 3mm
- H8021001 - 102mm x 67mm x 3.5mm
- H8021002 - 102mm x 76mm x 4mm

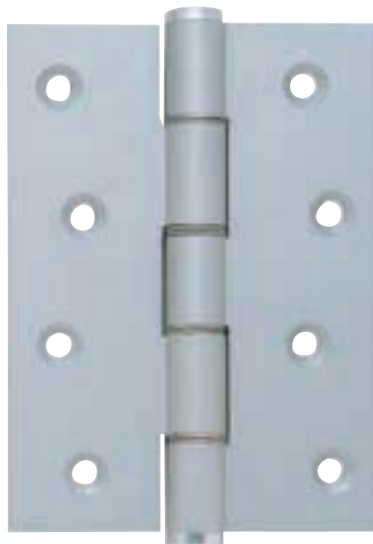

**ALUMINIUM HINGE STAINLESS STEEL WASHER**

- H8021025 - 76mm x 50mm x 3mm
- H8021026 - 102mm x 67mm x 3.5mm



**SOLID DRAWN COPPER ON BRASS HINGE**

- H8021003 - 38mm x 30mm
- H8021004 - 50mm x 30mm
- H8021005 - 60mm x 34mm
- H8021006 - 75mm x 41mm
- H8021007 - 102mm x 60mm

Hinges

**Wardrobe Rail & Fittings**

Hanging Rail



**CENTRE BRACKET CP**

H8090011 - 19mm  
H8090111 - 25mm

**CENTRE BRACKET PB**

H8080011 - 19mm  
H8080111 - 25mm



**END SOCKET CP**

H8090021 - 19mm  
H8090121 - 25mm

**END SOCKET PB**

H8080021 - 19mm  
H8080121 - 25mm

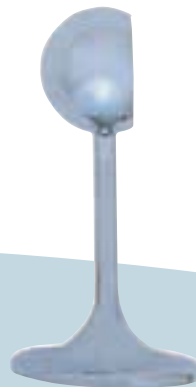

**END BRACKET CP**

H8090031 - 19mm  
H8090131 - 25mm

**END BRACKET PB**

H8080031 - 19mm  
H8080131 - 25mm

**T100 CP TUBE**

19mm diameter:

- H8090001 - 610mm (2ft)
- H8090002 - 915mm (3ft)
- H8090003 - 1220mm (4ft)
- H8090004 - 1525mm (5ft)
- H8090005 - 1838mm (6ft)
- H8090006 - 2500mm (8ft)

25mm diameter:

- H8090101 - 610mm (2ft)
- H8090102 - 915mm (3ft)
- H8090103 - 1220mm (4ft)
- H8090104 - 1525mm (5ft)
- H8090105 - 1838mm (6ft)
- H8090106 - 2500mm (8ft)

**T100 EB TUBE**

19mm diameter:

- H8080001 - 610mm (2ft)
- H8080002 - 915mm (3ft)
- H8080003 - 1220mm (4ft)
- H8080004 - 1525mm (5ft)
- H8080005 - 1838mm (6ft)
- H8080006 - 2500mm (8ft)

25mm diameter:

- H8080101 - 610mm (2ft)
- H8080102 - 915mm (3ft)
- H8080103 - 1220mm (4ft)
- H8080104 - 1525mm (5ft)
- H8080105 - 1838mm (6ft)
- H8080106 - 2500mm (8ft)



**CENTRE BRACKET CP**

H8090031 - 19mm  
H8090131 - 25mm

**CENTRE BRACKET PB**

H8080031 - 19mm  
H8080131 - 25mm

**Cabinet Furniture**

Cabinet Fittings



**SATIN CHROME**

H8002033 - 32mm  
H8100051 - 25mm  
H8002034 - 38mm



**BRASS**

H8000062 - 32mm  
H8100040 - 25mm  
H8000063 - 38mm



**POLISHED CHROME**

H8001052 - 32mm  
H8100050 - 25mm  
H8001053 - 38mm



**HOLLOW BOLT FIX  
BRASS**

H8100003 - 25mm  
H8100004 - 32mm  
H8100005 - 38mm



**CUPBOARD KNOB  
BRUSHED STEEL**

H8100001 - 18mm  
H8100002 - 13mm



**CUPBOARD KNOB  
WHITE/GOLD**

H8100092 - 37mm  
H8100093 - 45mm  
H8100091 - 30mm  
H8100090 - 25mm

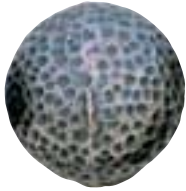

**CUPBOARD KNOB  
IRON**

H8100041 - 40mm  
H8100042 - 30mm



**CRYSTAL KNOB  
BRASS ROSE**

H8100020 - 35mm  
H8100021 - 30mm  
H8100022 - 25mm



**BLACK NICKEL GOLD**

H8100030 - 33mm  
H8100031 - 28mm  
H8100032 - 24mm  
H8100033 - 18mm



**PINE UNVARNISHED  
KNOB**

H8100044 - 38mm  
H8100045 - 30mm



**CUPBOARD KNOB  
BRASS ROSE**

H8100016 - 35mm  
H8100017 - 30mm  
H8100018 - 25mm



**HOLLOW SCREW FIX**

H8100003 - 25mm  
H8100004 - 32mm  
H8100005 - 38mm



**PINE VARNISHED KNOB**

H8100046 - 38mm  
H8100047 - 30mm



**CUPBOARD KNOB  
BLACK ANTIQUE**

H8100010 - 25mm  
H8100011 - 32mm  
H8100012 - 38mm



**OVAL CUPBOARD KNOB  
BLACK ANTIQUE**

H8100014 - 38mm



**Cabinet Furniture**

Cabinet Fittings



**BRIGHT BRASS**  
 H8000061 - 127mm



**POLISHED CHROME**  
 H8001051 - Chrome



**BRUSHED STAINLESS**  
 H8100060 - 127mm



**BLACK/NICKEL /BRASS**  
 H8100061 - 127mm



H8100062 - 132mm  
**BRUSH STAINLESS**



**FLEUR DE LYS CABINET HANDLE**  
 H8100064 - 102mm  
 H8100065 - 152mm  
 H8100066 - 175mm



**PULL HANDLE**  
 H8100070 - 102mm



**CABINET HANDLE**  
 H8100071 - 89mm  
 H8100071 - 102mm



**CABINET HANDLE**  
 H8100073 - 89mm  
 H8100074 - 102mm



**CABINET HANDLE**  
 H8100075 - 89mm  
 H8100076 - 102mm



H8100080 - 85mm  
**CABINET HANDLE**



**DRAWER PULL**  
 H8100082 - 76mm

## Stays and Fasteners

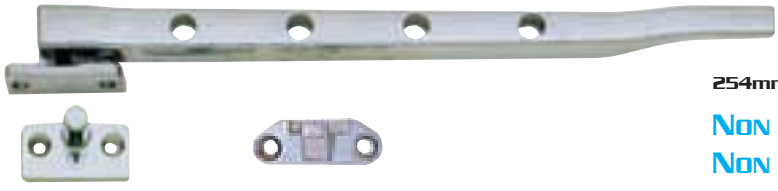

254mm

**NON LOCKABLE STAY** H8200001 - Chrome

**NON LOCKABLE STAY** H8200002 - White

**NON LOCKABLE STAY** H8200003 - Brass



254mm

**LOCKABLE STAY** H8200102 - White

**LOCKABLE STAY** H8200101 - Brass

**LOCKABLE STAY** H8200101 - Chrome



254mm

**NON LOCKABLE STAY** H8200203 - Brass

**NON LOCKABLE STAY** H8200201 - Chrome

**NON LOCKABLE STAY** H8200202 - White



254mm

**LOCKABLE STAY** H8200301 - Chrome

**NON LOCKABLE STAY** H8200302 - White

**NON LOCKABLE STAY** H8200303 - Brass



**LOCKABLE CASEMENT FASTENER**

H8200502 - 120mm White

**LOCKABLE CASEMENT FASTENER**

H8200501 - 120mm Chrome

**LOCKABLE CASEMENT FASTENER**

H8200503 - 120mm Brass



**NON LOCKABLE CASEMENT FASTENER**

H8200403 - 120mm Brass

**NON LOCKABLE CASEMENT FASTENER**

H8200402 - 120mm White

**NON LOCKABLE CASEMENT FASTENER**

H8200401 - 120mm Chrome

## Ventilators

### SLOTTED

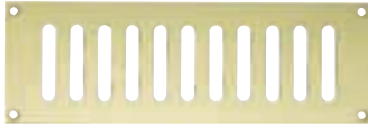

- H8300001 - PB 152mm x 76mm
- H8300002 - PB 225mm x 76mm
- H8300003 - PB 225mm x 150mm
- H8300004 - PB 225mm x 225mm
- H8300005 - PB 305mm x 76mm
- H8300006 - PB 305mm x 150mm
- H8300007 - PB 305mm x 305mm

### HIT & Miss



- H8300401 - PB 152mm x 76mm
- H8300402 - PB 225mm x 76mm
- H8300403 - PB 225mm x 150mm
- H8300404 - PB 225mm x 225mm
- H8300405 - PB 305mm x 76mm
- H8300406 - PB 305mm x 150mm
- H8300407 - PB 305mm x 305mm

### LOUVRE

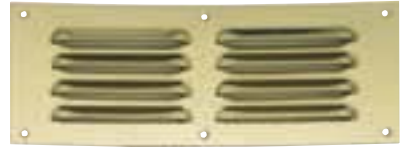

- H8300201 - PB 152mm x 76mm
- H8300202 - PB 225mm x 76mm
- H8300203 - PB 225mm x 150mm
- H8300204 - PB 225mm x 225mm
- H8300205 - PB 305mm x 76mm
- H8300206 - PB 305mm x 150mm
- H8300207 - PB 305mm x 305mm



- H8300101 - SAA 152mm x 76mm
- H8300102 - SAA 225mm x 76mm
- H8300103 - SAA 225mm x 150mm
- H8300104 - SAA 225mm x 225mm
- H8300105 - SAA 305mm x 76mm
- H8300106 - SAA 305mm x 150mm
- H8300107 - SAA 305mm x 305mm



- H8300501 - SAA 152mm x 76mm
- H8300502 - SAA 225mm x 76mm
- H8300503 - SAA 225mm x 150mm
- H8300504 - SAA 225mm x 225mm
- H8300505 - SAA 305mm x 76mm
- H8300506 - SAA 305mm x 150mm
- H8300507 - SAA 305mm x 305mm



- H8300301 - SAA 152mm x 76mm
- H8300302 - SAA 225mm x 76mm
- H8300303 - SAA 225mm x 150mm
- H8300304 - SAA 225mm x 225mm
- H8300305 - SAA 305mm x 76mm
- H8300306 - SAA 305mm x 150mm
- H8300307 - SAA 305mm x 305mm



- H0741503 - CP 229mm x 76mm
- H0741513 - CP 229mm x 152mm
- H0741523 - CP 229mm x 229mm
- H0741533 - CP 305mm x 152mm



- H0742503 - CP 229mm x 76mm
- H0742513 - CP 229mm x 152mm
- H0742523 - CP 229mm x 229mm
- H0742533 - CP 305mm x 152mm



- H0744001 - White Nylon 229mm x 76mm
- H0744011 - White Nylon 229mm x 152mm



- H0743501 - White Nylon 152mm x 76mm
- H0743511 - White Nylon 229mm x 76mm
- H0743521 - White Nylon 229mm x 152mm
- H0743531 - White Nylon 229mm x 229mm

## Brass Grilles for Radiator Covers



**PERFORATED BRASS SHEET**



**DIAMOND GRILLE PATTERN**



**DIAMOND GRILLE PATTERN**



**DIAMOND GRILLE PATTERN**



**PERFORATED BRASS SHEET**



**DIAMOND GRILLE PATTERN**



# Radiator Grilles

ALL PATTERNS ARE AVAILABLE IN SHEET SIZE 1830 X 975MM OR CUT TO SIZE  
ALL ITEMS ON THIS PAGE ARE AVAILABLE TO ORDER ONLY - PLEASE TELEPHONE FOR QUOTATION.

**Espagnolette Bolts**

Casement Bolts



**POLISHED CHROME**

To suit doors up to 2700mm high.

**H8001065**



**POLISHED BRASS**

To suit doors up to 2700mm high.

**H7000164**



**BLACK ANTIQUE**

To suit doors up to 2700mm high.

**H8070062**



**POLISHED BRASS**

To suit doors up to 2700mm high.

**H7000163 - 2700mm**



**PEWTER**

To suit doors up to 2700mm high.

**H8070063 - 2745mm**



**SATIN CHROME**

To suit doors up to 2700mm high.

**H8002012 - 2745mm**



**LOCKING ATTACHMENT**

**H7000165**



For more information go to [www.barbourproductsearch.info](http://www.barbourproductsearch.info)  
**N&L Olympus Designer**

**N&C**  
*Olympus*



# Home Style Designer Range

A stylish collection of lever furniture offering classical and modern designs in a choice of finishes to add the perfect finishing touch to a variety of interiors.

**N&C**  
Building Materials

Olympus

### Angelo Lever on Rose



**POLISHED CHROME**  
H8003002 - 48mm Rose



**SATIN CHROME**  
H8003003 - 48mm Rose



**POLISHED BRASS**  
H8003001 - 48mm Rose

### Camillo Lever on Rose



**SATIN CHROME**  
H8004003 - 50mm Rose

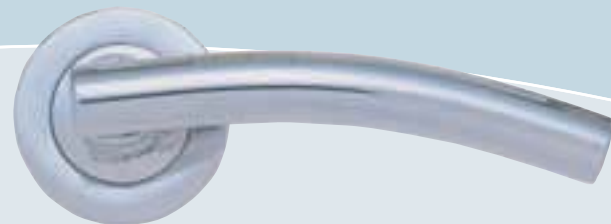

**POLISHED CHROME**  
H8004002 - 50mm Rose



**POLISHED BRASS**  
H80004001 - 50mm Rose

Designer Range

## Lucio Lever on Rose



**POLISHED CHROME**  
H8005002 - 48mm Rose



**POLISHED BRASS**  
H8005001 - 48mm Rose



**SATIN CHROME**  
H8005003 - 48mm Rose

## Palamon Lever on Rose



**POLISHED BRASS**  
H8006001 - 48mm Rose



**POLISHED CHROME**  
H8006002 - 48mm Rose



**SATIN CHROME**  
H8006003 - 48mm Rose

Designer Range

## Concealed Escutcheon and Turn & Releases

Matching pattern for Angelo, Camillo, Lucio & Palamon



50mm

### CONCEALED ESCUTCHEON

OVAL PROFILE

- H8030201 - Polished Brass
- H8030202 - Polished Chrome
- H8030203 - Satin Chrome



### TURN & RELEASE

- H8030302 - 50mm Polished Chrome



50mm

### CONCEALED ESCUTCHEON

STANDARD KEYWAY

- H8030001 - Polished Brass
- H8030002 - Polished Chrome
- H8030003 - Satin Chrome



### TURN & RELEASE

- H8030301 - 50mm Polished Brass



50mm

### CONCEALED ESCUTCHEON

EURO PROFILE

- H8030101 - Polished Brass
- H8030102 - Polished Chrome
- H8030103 - Satin Chrome



### TURN & RELEASE

- H8030303 - 50mm Satin Chrome

## Orpheus Lever on Rose



H8007001 - 48mm Rose  
**POLISHED BRASS**



H8007002 - 48mm Rose  
**POLISHED CHROME**



H8007003 - 48mm Rose  
**SATIN CHROME**

## Stribo Lever on Rose



**POLISHED BRASS**  
H8008001 - 48mm Rose



**POLISHED CHROME**  
H8008002 - 48mm Rose



**SATIN CHROME**  
H8008003 - 48mm Rose

Designer Range



## Concealed Escutcheon and Turn & Releases

Matching pattern for Orpheus & Stribo



50mm

### CONCEALED ESCUTCHEON

STANDARD KEYWAY

- H8040001 - Polished Brass
- H8040002 - Polished Chrome
- H8040003 - Satin Chrome



### TURN & RELEASE

H8040301 - 50mm Polished Brass



50mm

### CONCEALED ESCUTCHEON

EURO PROFILE

- H8040101 - Polished Brass
- H8040102 - Polished Chrome
- H8040103 - Satin Chrome



### TURN & RELEASE

H8040302 - 50mm Polished Chrome



### CONCEALED ESCUTCHEON

OVAL PROFILE

- H8040201 - 50mm Polished Brass
- H8040202 - 50mm Polished Chrome
- H8040203 - 50mm Satin Chrome



### TURN & RELEASE

H8040303 - 50mm Satin Chrome

## Cronus Lever on Rose

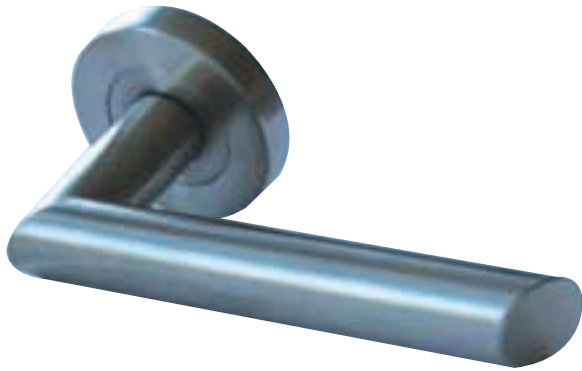

**SATIN STAINLESS STEEL**  
H3800004 - 54mm Rose



**POLISHED STAINLESS STEEL**  
H3800003 - 54mm Rose

## Nessus Lever on Rose



**SATIN STAINLESS STEEL**  
H3800104 - 54mm Rose



**POLISHED STAINLESS STEEL**  
H3800103 - 54mm Rose

Olympus

### Perdita Lever on Rose



**SATIN STAINLESS STEEL**  
H3800204 - 54mm Rose



**POLISHED STAINLESS STEEL**  
H3800203 - 54mm Rose

### Solano Lever on Rose



**SATIN STAINLESS STEEL**  
H3800304 - 54mm Rose



**POLISHED STAINLESS STEEL**  
H3800303 - 54mm Rose

Designer Range

## Concealed Escutcheon and Turn & Releases

Matching pattern for Angelo, Cronus, Nessus, Perdita & Solanio



50mm

### CONCEALED ESCUTCHEON

STANDARD KEYWAY

H3804104 - Satin Stainless Steel

H3804103 - Polished Stainless Steel



50mm

### TURN & RELEASE

H3804404 - Satin Stainless Steel

H3804403 - Polished Stainless Steel



50mm

### CONCEALED ESCUTCHEON

EURO PROFILE

H3804204 - Satin Stainless Steel

H3804203 - Polished Stainless Steel



50mm

### EXTENDED TURN & RELEASE

H3804504 - Satin Stainless Steel

H3804503 - Polished Stainless Steel

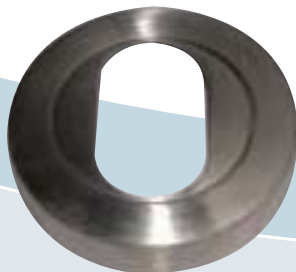

50mm

### CONCEALED ESCUTCHEON

OVAL PROFILE

H3804304 - Satin Stainless Steel

H3804303 - Polished Stainless Steel

Designer Range

### Dorcas Lever on Backplate



**DORCAS RANGE AVAILABLE TO SPECIAL ORDER ONLY IN POLISHED CHROME, SATIN CHROME AND POLISHED BRASS**

### Stribo Lever on Backplate

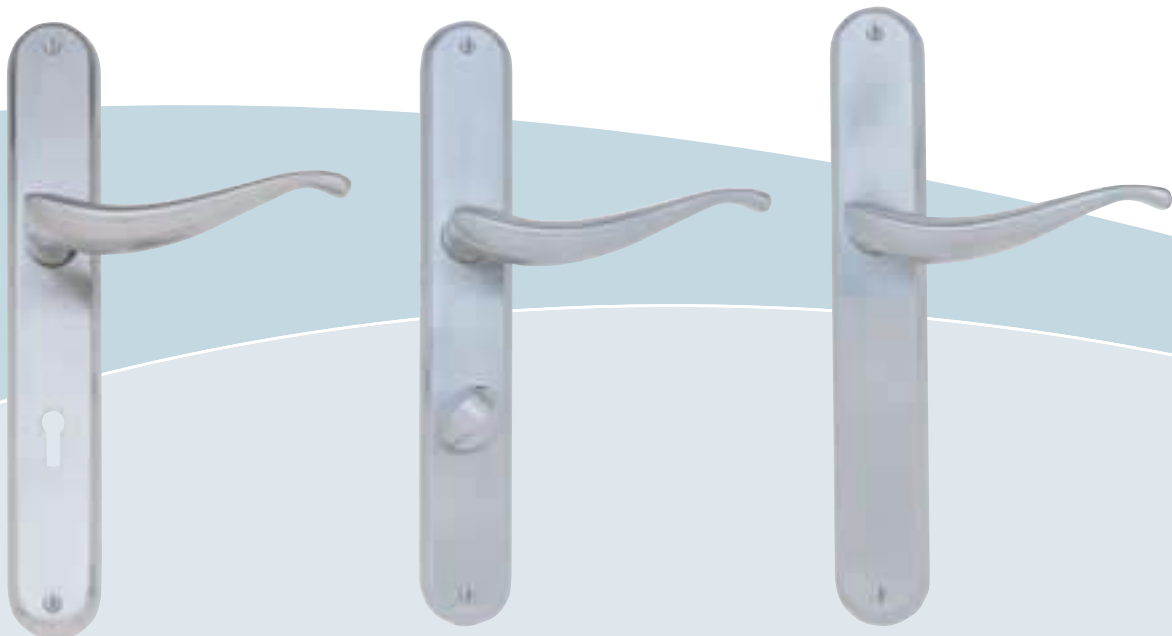

**STRIBO RANGE AVAILABLE TO SPECIAL ORDER ONLY IN POLISHED CHROME, SATIN CHROME AND POLISHED BRASS**





**N&C**  
*Olympus*

# Architectural Range

A range of products tailored for both contractors and specifiers. Featuring functional contemporary ironmongery to accommodate any specification or budget.

**Olympus Contractor Range**

Polished aluminium 19mm round bar furniture on 10mm roses & backplates

**LEVER ON ROSE**



H3900001 - 50 mm Diameter Rose

**LEVER LATCH SET**



H3901001 - 100mm x 40mm

**LEVER LATCH SET**



H3901101 - 152mm x 40mm

**LEVER LOCK SET**



H3901201 - 152mm x 40mm Standard Key

**LEVER LOCK SET**



H3901301 - 152mm x 40mm Euro Profile

**LEVER LOCK SET**



H3901501 - 152mm x 40mm Oval Profile

**BATHROOM FURNITURE**



H3901401 - 152mm x 40mm

**THUMBTURN & EMERGENCY RELEASE**



H3904401 - 50 mm Diameter

**CONCEALED FIX ESCUTCHEONS**  
50 mm Diameter



H3904101 - Standard Key  
H3904201 - Euro Profile  
H3904301 - Oval Profile

**BATHROOM INDICATOR BOLT**



H3904501

**STAMPED ROUND ESCUTCHEONS**



H0332501 - 32mm Diameter Covered  
H0331013 - 32mm Diameter Uncovered

**Olympus Contractor Range**

**PULL HANDLES**



**Bolt through Fixing**  
 H3906101 - 150mm  
 H3906201 - 225mm  
 H3906301 - 305mm

**PULL HANDLES**



**Rose Fixing**  
 H3906401 - 150mm  
 H3906501 - 225mm  
 H3906601 - 305mm

**PULL HANDLES**



**On Backplate**  
 H3906701 - 225mm  
 H3906801 - 305mm

**FINGER PLATES 165SWG**



H0380001 - Plain 305 x 64mm  
 H0380501 - Plain 305 x 76mm  
 H0381001 - Engraved 305 x 76mm  
 H0380601 - Plain 330 x 76mm

**KICKING PLATES 165SWG**



H0385001 - 675 x 152mm  
 H0385011 - 750 x 152mm  
 H0385021 - 825 x 152mm

**LEVER ACTION FLUSHBOLTS**



H3907001 - 150 x 25mm  
 H3907101 - 200 x 25mm  
 H3907201 - 305 x 25mm

**WALL MOUNTED DOOR STOP**



H0560001 - 65mm  
 H0560011 - 76mm

**SHIELDED DOOR STOP**



H0562001 - 40 x 30mm

**OVAL DOOR STOP**



H0563501 - 50 x 40mm

**CYLINDER PULL**



H0355501

**HAT & COAT HOOKS**



H0580001 - Hat & Coat Hook  
 125mm  
 H0580502 - Wardrobe Hook  
 50mm

**DISHED CUPBOARD KNOBS**



H0642501 - 32mm  
 H0642511 - 38mm

## Olympus Contractor Range

Polished Brass 19mm Round Bar Furniture on 10mm Roses

### LEVER ON ROSE



H39000002 - 50mm Diameter

### ESCUTCHEONS



H3904102 - 50mm Diameter  
Standard Key  
H3904202 - 50mm Diameter  
Euro Profile  
H3904302 - 50mm Diameter  
Oval Profile

### THUMBTURN & EMERGENCY RELEASE



H3904402 - 50mm

### PULL HANDLE



Rose Fixing  
H3906502 - 225mm  
H3906602 - 305mm

### FINGER PLATES 16SWG



H0380502 - Plain 305 x 76mm  
H0381002 - Engraved 305 x 76mm

### KICKING PLATES 16SWG

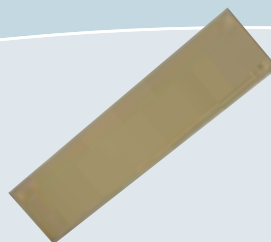

H0386501 - 675 x 152mm  
H0386511 - 750 x 152mm  
H0386521 - 825 x 152mm

### LEVER ACTION FLUSHBOLT



H3907002 - 152 x 19mm  
H3907102 - 200 x 19mm  
H3907202 - 305 x 25mm

**Olympus Contractor Range**

Polished Chrome 19mm Round Bar Furniture on 10mm Roses

**LEVER ON ROSE**



H3900003 - 50mm Diameter

**ESCUTCHEONS**



H3904103 - 50mm Diameter Standard Key  
 H3904203 - 50mm Diameter Euro Profile  
 H3904303 - 50mm Diameter Oval Profile

**THUMBTURN & EMERGENCY RELEASE**



H3904403 - 50mm

**PULL HANDLE**



Rose Fixing  
 H3906503 - 225mm  
 H3906603 - 305mm

Contractor

**FINGER PLATES 16SWG**



H0380502 - Plain 305 x 76mm  
 H0381003 - Engraved 305 x 76mm

**KICKING PLATES 16SWG**

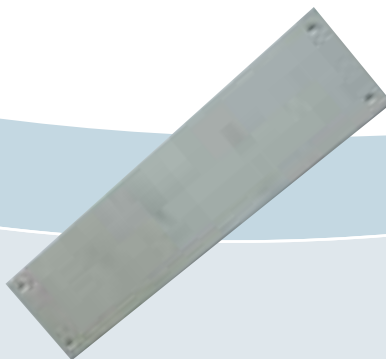

H0386801 - 675 x 152mm  
 H0386811 - 750 x 152mm  
 H0386821 - 825 x 152mm

**LEVER ACTION FLUSHBOLT**



H0489101 - 152 x 19mm  
 H0489102 - 200 x 19mm  
 H0489103 - 305 x 25mm



**Olympus Specifier Range**

Stainless Steel 19mm Round Bar Furniture Manufactured From Grade 304 stainless steel on 10mm Sprung Roses and Backplates.  
 Available in Satin or Polished Stainless Steel Finishes.

**LEVER ON ROSE**



54mm Diameter  
 H3700004 - Satin  
 H3700003 - Polished

**LEVER LATCH SET**



165mm x 45mm  
 H3701104 - Satin  
 H3701103 - Polished

**LEVER LOCK SET**



165mm x 45mm  
 H3701204 - Satin  
 H3701203 - Polished

**EURO LOCK SET**



165mm x 45mm  
 H3701304 - Satin  
 H3701303 - Polished

**OVAL LOCK SET**



165mm x 45mm  
 H3701504 - Satin

**BATHROOM FURNITURE**



165mm x 45mm  
 H3701404 - Satin  
 H3701403 - Polished

**ESCUTCHEON  
 STANDARD KEYWAY**

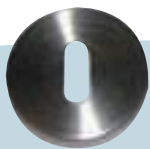

H3704104 - 50mm Diameter Satin  
 H3704103 - 50mm Diameter Polished

**ESCUTCHEON  
 EURO PROFILE**



H3704204 - 50mm Diameter Satin  
 H3704203 - 50mm Diameter Polished

**ESCUTCHEON  
 OVAL PROFILE**

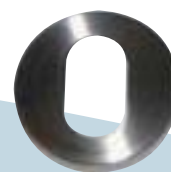

H3704304 - 50mm Diameter Satin  
 H3704303 - 50mm Diameter Polished

**THUMBTURN EMERGENCY RELEASE**



50mm Diameter  
 H3704404 - Satin  
 H3704403 - Polished

**EXTENDED THUMBTURN &  
 EMERGENCY RELEASE**



50mm Diameter  
 H3704504 - Satin  
 H3704503 - Polished

**SQUARE PLATE  
 FURNITURE**



Available to special order in latch, lock and bathroom styles.  
 Plate size - 162 x 162 x 2mm

Specifier

## Olympus Specifier Range

### PULL HANDLES BOLT THROUGH



H3706104 - 150mm Satin  
H3706103 - 150mm Polished

H3706404 - 225mm Satin  
H3706403 - 225mm Polished

H3706704 - 300mm Satin  
H3706703 - 300mm Polished

### PULL HANDLE FIXINGS FOR USE WITH BOLT THROUGH PULL HANDLES TO CHANGE FIXING

Single Disc Fitting for Glass Doors  
H3706504 - Satin  
H3706503 - Polished

Back to Back Fixing Timber, Metal & Glass  
Doors - use with surface fix handles.  
H3707003

50 x 10mm Roses can be used with all fixings  
H3706804 - Satin  
H3706803 - Polished

### Pull Handles Surface Fixing



H3706004 - 150mm Satin  
H3706004 - 150mm Polished

H3706004 - 225mm Satin  
H3706004 - 225mm Polished

H3706004 - 300mm Satin  
H3706004 - 300mm Polished

### PULL HANDLES ON BACKPLATE



on Backplate  
Handle 225 x 19mm  
Plate 300 x 75mm  
H3706204 - Satin  
H3706203 - Polished

### PLAIN FINGER PLATE 165SWG



H0380505 - 305 x 76mm Satin  
H0380506 - 305 x 76mm Polished  
H0380605 - 330 x 76mm Satin  
H0380606 - 335 x 76mm Polished

### ENGRAVED FINGER PLATE 165SWG



H0381012 - 305 x 76mm Satin  
H0381006 - 305 x 76mm Polished

Specifier

**Olympus Specifier Range**

**KICKING PLATES 16SWG**



- H0387001 - 675 x 152mm Satin
- H0387701 - 675 x 152mm Polished
- H0387011 - 750 x 152mm Satin
- H0387711 - 750 x 152mm Polished
- H0387021 - 825 x 152mm Satin
- H0387721 - 825 x 152mm Polished

**LEVER ACTION FLUSHBOLT**



- H0489201 - 150 x 19mm Satin
- H0489301 - 150 x 19mm Polished
- H0489202 - 200 x 19mm Satin
- H0489302 - 200 x 19mm Polished

**CUPBOARD KNOB**



- H3811404 - 25mm Diameter Satin
- H3811403 - 25mm Diameter Polished
- H3811504 - 32mm Diameter Satin
- H3811503 - 32mm Diameter Polished
- H3811604 - 38mm Diameter Satin
- H3811603 - 38mm Diameter Polished

**WALL MOUNTED DOOR STOP**



- H3711904 - 75 x 16mm Satin
- H3711903 - 75 x 16mm Polished

**WALL MOUNTED DOOR STOP ON ROSE**



- H3711004 - 75 x 16mm Satin
- H3711003 - 75 x 16mm Polished

**FLOOR MOUNTED DOOR STOP**



- H3712104 - 30mm Diameter Satin
- H3712103 - 30mm Diameter Polished

**BUFFERED HAT & COAT HOOK**



- H3714004 - Satin
- H3714003 - Polished

**BUFFERED COAT HOOK**



- H3714104 - Satin
- H3714103 - Polished

**SPRUNG LETTER PLATE**

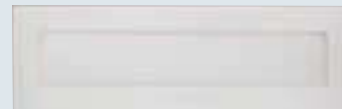

- H3709104 - 305 x 102mm Satin
- H3709103 - 305 x 102mm Polished

## Olympus Architect Range

A premium range of furniture with four handle designs and finishes made from the highest quality materials and backed by a 10 year guarantee.

### 75 Slimline Levers

Lever length 120mm projection 60mm

#### STRAIGHT LEVER



H3600001 - PAA  
H3600003 - PSS  
H3600004 - SSS

#### RETURN TO DOOR LEVER



H3600101 - PAA  
H3600103 - PSS  
H3600104 - SSS

### Roundline Levers

19mm Diameter, Lever Length 130mm Projection 66mm

#### STRAIGHT LEVER



H3600301 - PAA  
H3600302 - PB  
H3600303 - PSS  
H3600304 - SSS

#### RETURN TO DOOR LEVER



H3600201 - PAA  
H3600302 - PB  
H3600203 - PSS  
H3600204 - SSS

#### CYLINDER KNOB



H3600701 - PAA

**Olympus Architect Range**

**Roses & Backplates**

**Covered Rose**

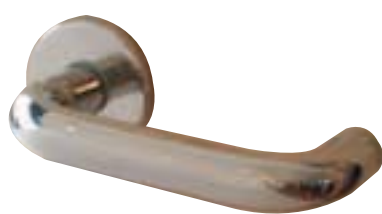

50mm x 5mm Unsprung Rose  
 H3601001 - PAA  
 H3601002 - PB  
 H3601003 - PSS  
 H3601004 - SSS

**LATCH PLATE**



180 x 52 x 5mm Unsprung  
 H3601101 - PAA  
 H3601102 - PB  
 H3601103 - PSS  
 H3601104 - SSS  
  
 180 x 52 x 5mm Sprung  
**TO SPECIAL ORDER ONLY**

**LEVER KEY LOCK PLATE**



57mm Centres  
 180 x 52 x 5mm Unsprung  
 H3601201 - PAA  
 H3601202 - PB  
 H3601203 - PSS  
 H3601204 - SSS  
  
 180 x 52 x 5mm Sprung  
**TO SPECIAL ORDER ONLY**

**EURO PROFILE LOCK PLATE**



57mm Centres  
 180 x 52 x 5mm Unsprung  
 H3601301 - PAA  
 H3601302 - PB  
 H3601303 - PSS  
 H3601304 - SSS

**OVAL PROFILE LOCK BACKPLATE**



56mm Centres  
 180 x 52 x 5mm Unsprung  
 H3601501 - PAA  
 H3601502 - PB  
 H3601503 - PSS  
 H3601504 - SSS

**BATHROOM BACKPLATE**



56mm Centres  
 180 x 52 x 5mm Unsprung  
 H3601401 - PAA  
 H3601402 - PB  
 H3601403 - PSS  
 H3601404 - SSS

180 x 52 x 5mm sprung  
**TO SPECIAL ORDER ONLY**

180 x 52 x 5mm sprung  
**TO SPECIAL ORDER ONLY**

180 x 52 x 5mm sprung  
**TO SPECIAL ORDER ONLY**

1



**FURNITURE ON SQUARE BACKPLATE**

Available to special order only in latch, lock and bathroom styles.

Plate Size 150 x 150 x 3mm - PAA and PB  
 Plate Size 150 x 150 x 1.6mm - PSS and SSS



**Olympus Architect Range**

**LEVER KEY ESCUTCHEON**



52mm x 5mm  
 H3604101 - PAA  
 H3604102 - PB  
 H3604103 - PSS  
 H3604104 - SSS

**EURO PROFILE ESCUTCHEON**



52mm x 5mm  
 H3604201 - PAA  
 H3604202 - PB  
 H3604203 - PSS  
 H3604204 - SSS

**OVAL PROFILE ESCUTCHEON**



52mm x 5mm  
 H3604301 - PAA  
 H3604302 - PB  
 H3604303 - PSS  
 H3604304 - SSS

**BLANK ESCUTCHEON**



52mm x 5mm  
 H3604001 - PAA  
 H3604002 - PB  
 H3604003 - PSS  
 H3604004 - SSS

**THUMBTURN ON ROSE**



52mm x 5mm  
 H3604501 - PAA  
 H3604502 - PB  
 H3604503 - PSS  
 H3604504 - SSS

**EMERGENCY RELEASE**



52mm x 5mm  
 H3604401 - PAA  
 H3604402 - PB  
 H3604403 - PSS  
 H3604404 - SSS

**LARGE THUMB TURN & RELEASE SET**



52mm x 5mm  
 H3604601 - PAA  
 H3604602 - PB  
 H3604603 - PSS  
 H3604604 - SSS

**PUSH PLATES**



PAA & PB 3mm Thickness SSS & PSS 1.6mm Thickness

H3608001 - PAA 300 x 65mm  
 H3608002 - PB 300 x 65mm  
 H3608003 - PSS 300 x 65mm  
 H3608004 - SSS 300 x 65mm

H3609001 - PAA 375 x 65mm  
 H3609002 - PB 375 x 65mm  
 H3609003 - PSS 375 x 65mm  
 H3609004 - SSS 375 x 65mm

**Olympus Architect Range**

**Slimline Pull Handles**

**BOLT THROUGH FIXING**



- 150mm
- H3605101 - PAA
- H3605103 - PSS
- H3605104 - SSS
- 225mm
- H3605401 - PAA
- H3605403 - PSS
- H3605404 - SSS
- 300mm
- H3605701 - PAA
- H3605703 - PSS
- H3605704 - SSS

**BACK TO BACK FIXING**



- 150mm
- H3605201 - PAA
- H3605203 - PSS
- H3605204 - SSS
- 225mm
- H3605501 - PAA
- H3605503 - PSS
- H3605504 - SSS
- 300mm
- H3605801 - PAA
- H3605803 - PSS
- H3605804 - SSS

**CONCEALED FIXING**



- 150mm
- H3605001 - PAA
- H3605003 - PSS
- H3605004 - SSS
- 225mm
- H3605301 - PAA
- H3605303 - PSS
- H3605304 - SSS
- 300mm
- H3605601 - PAA
- H3605603 - PSS
- H3605604 - SSS

**Roundline Pull Handles**

**BOLT THROUGH FIXING**



- 150mm
- H3606101 - PAA
- H3606102 - PB
- H3606103 - PSS
- H3606104 - SSS
- 225mm
- H3606401 - PAA
- H3606402 - PB
- H3606403 - PSS
- H3606404 - SSS
- 300mm
- H3606701 - PAA
- H3606702 - PB
- H3606703 - PSS
- H3606704 - SSS

**BACK TO BACK FIXING**



- 150mm
- H3606201 - PAA
- H3606202 - PB
- H3606203 - PSS
- H3606204 - SSS
- 225mm
- H3606501 - PAA
- H3606502 - PB
- H3606503 - PSS
- H3606504 - SSS
- 300mm
- H3606801 - PAA
- H3606802 - PB
- H3606803 - PSS
- H3606804 - SSS

**CONCEALED FIXING**



- 150mm
- H3606001 - PAA
- H3606002 - PB
- H3606003 - PSS
- H3606004 - SSS
- 225mm
- H3606301 - PAA
- H3606302 - PB
- H3606303 - PSS
- H3606304 - SSS
- 300mm
- H3606601 - PAA
- H3606602 - PB
- H3606603 - PSS
- H3606604 - SSS

Olympus

Architect

**Olympus Architect Range**

**Signage**



70mm Diameter  
Screw Fixes  
H3611401 - PAA  
H3611402 - PB  
H3611403 - PSS  
H3611404 - SSS

70mm Diameter  
Screw Fixes  
H3611501 - PAA  
H3611502 - PB  
H3611503 - PSS  
H3611504 - SSS

70mm Diameter  
Screw Fixes  
H3611601 - PAA  
H3611602 - PB  
H3611603 - PSS  
H3611604 - SSS

70mm Diameter  
Screw Fixes  
H3611701 - PAA  
H3611702 - PB  
H3611703 - PSS  
H3611704 - SSS

70mm Diameter  
Screw Fixes  
H3611801 - PAA  
H3611802 - PB  
H3611803 - PSS  
H3611804 - SSS

**Hat & Coat Hooks**

**HAT & COAT HOOK**

**COAT HOOK**

**BUFFERED HAT & COAT HOOK**

**HAT & COAT HOOK**

**COAT HOOK**

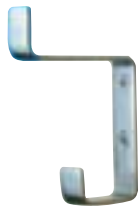

60mm x 84mm  
H3614001 - PAA  
H3614003 - PSS  
H3614004 - SSS

32mm x 62mm  
H3614101 - PAA  
H3614103 - PSS  
H3614104 - SSS

63mm x 87mm  
H3614201 - PAA  
H3614203 - PSS  
H3614204 - SSS

65mm x 115mm  
H3614302 - PB

38mm x 15mm  
H3614402 - PB

**WALL MOUNTED DOOR STOP**

**FLOOR MOUNTED DOOR STOP**

**LEVER ACTION FLUSHBOLT**

**LEVER ACTION FLUSHBOLT**



75mm Projection  
H3612001 - PAA  
H3612002 - PB  
H3612003 - PSS  
H3612004 - SSS

40mm Diameter  
H3612101 - PAA  
H3612102 - PB  
H3612103 - PSS  
H3612104 - SSS

200mm x 18mm  
H0488104 - SSS

25mm x 225mm  
H0488101 - PAA  
H0488102 - PB

## Olympus Architectural Locks

### 5 LEVER SASH LOCK



Depth 63 or 76mm  
Height 108mm  
Forend 152 x 25.5mm  
Centres 57mm

Backset  
63mm Case = 43mm  
76mm Case = 57mm

H3620002 - 63mm Brass  
H3620046 - 63mm Satin  
H3620102 - 76mm Brass  
H3620104 - 76mm Satin

H3620402 - 13mm Rebate Kit Brass  
H3620404 - 13mm Rebate Kit Satin

### 5 LEVER BS3621 SASH LOCK



Depth 63 or 76mm  
Height 108mm  
Forend 152 x 25.5mm  
Centres 57mm

Backset  
63mm Case = 43mm  
76mm Case = 57mm

H3621002 - 63mm Brass  
H3621004 - 63mm Satin  
H3621102 - 76mm Brass  
H3621104 - 76mm Satin  
H3621402 - 13mm Rebate Kit  
H3621404 - 13mm Rebate Kit

**NB IF using Rebate Kit lock Does Not Comply to BS3621**

### 5 LEVER DEAD LOCKS

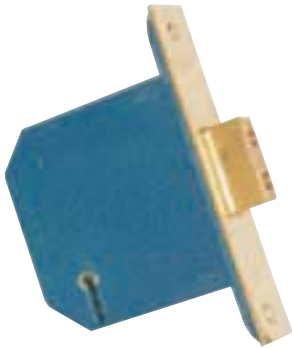

Depth 63 or 76mm  
Height 76.5mm  
Forend 152 x 25.5mm

Backset  
63mm Case = 43mm  
76mm Case = 57mm

H3620202 - 63mm Brass  
H3620204 - 63mm Satin  
H3620302 - 76mm Brass  
H3620304 - 76mm Satin

H3620502 - 13mm Rebate Kit Brass  
H3620504 - 13mm Rebate Kit Satin

### 5 LEVER BS3621 DEAD LOCK

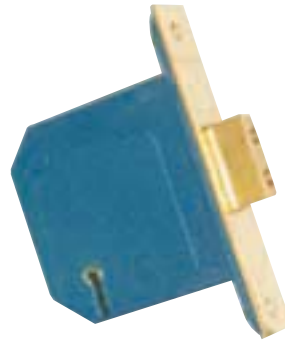

Depth 63 or 76mm  
Height 76.5mm  
Forend 152 x 25.5mm

Backset  
63mm Case = 43mm  
76mm Case = 57mm

H3621202 - 63mm Brass  
H3621204 - 63mm Satin  
H3621302 - 76mm Brass  
H3621304 - 76mm Satin  
H3621502 - 13mm Rebate Kit  
H3621504 - 13mm Rebate Kit

**NB IF using Rebate Kit lock Does Not Comply to BS3621**

### BATHROOM LOCKS

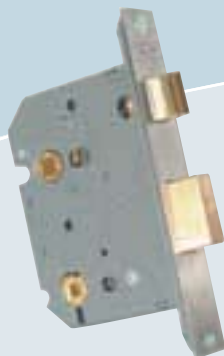

Depth 63 or 76mm  
Height  
Forend

Backset  
63mm Case = 43mm  
76mm Case = 57mm

H3621602 - 63mm Brass  
H3621604 - 63mm Satin  
H3621702 - 76mm Brass  
H3621704 - 76mm Satin

### FULL CASE LATCH

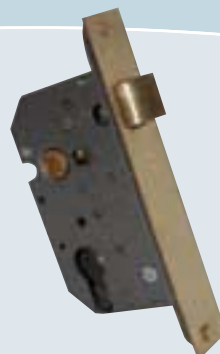

Depth 63 or 76mm  
Height 108mm  
Forend 152 x 25.5mm

Backset  
63mm Case = 43mm  
76mm Case = 57mm

H3621802 - 63mm Brass  
H3621804 - 63mm Satin  
H3621902 - 76mm Brass  
H3621904 - 76mm Satin

## Olympus Architectural Locks

### EURO PROFILE SASH LOCK CASE



Depth 63 or 76mm  
 Height 108mm  
 Forend 152 x 25.5mm  
 Centres 57mm

Backset  
 63mm Case = 43mm  
 76mm Case = 57mm

- H3630002 - 63mm Brass
- H3630004 - 63mm Satin
- H3630102 - 76mm Brass
- H3630104 - 76mm Satin

### EURO PROFILE FULL CASE DEAD LOCK



Depth 63 or 76mm  
 Height 108mm  
 Forend 152 x 25.5mm

Backset  
 63mm Case = 43mm  
 76mm Case = 57mm

- H3630402 - 63mm Brass
- H3630404 - 63mm Satin
- H3630502 - 76mm Brass
- H3630504 - 76mm Satin

### EURO PROFILE SMALL CASE DEAD LOCK



Depth 63 or 76mm  
 Height 76.5mm  
 Forend 121 x 25.5mm  
 Backset  
 63mm Case = 43mm  
 76mm Case = 57mm

- H3630202 - 63mm Brass
- H3630204 - 63mm Satin
- H3630302 - 76mm Brass
- H3630304 - 76mm Satin

### EURO PROFILE MORTICE NIGHTLATCH CASE



With Holdback Facility  
 Depth 63 or 76mm  
 Height 108mm  
 Forend 152 x 25.5mm  
 Centres 47mm

Backset  
 63mm Case = 43mm  
 76mm Case = 57mm

- H3630602 - 63mm Brass
- H3630604 - 63mm Satin
- H3630702 - 76mm Brass
- H3630704 - 76mm Satin

N.B. For Rebate kits for Euro profile Range see next page

## Euro Profile Cylinders

### SINGLE CYLINDER



- H3631002 - 40mm Brass
- H3631102 - 45mm Brass
- H3631202 - 50mm Brass
- H3631004 - 40mm Satin
- H3631104 - 45mm Satin
- H3631204 - 50mm Satin

### DOUBLE CYLINDER



- H3632002 - 60mm Brass
- H3632102 - 70mm Brass
- H3632202 - 80mm Brass
- H3632004 - 60mm Satin
- H3632104 - 70mm Satin
- H3632204 - 80mm Satin

### CYLINDER & THUMBTURN



- H3633002 - 60mm Brass
- H3633102 - 70mm Brass
- H3633202 - 80mm Brass
- H3633004 - 60mm Satin
- H3633104 - 70mm Satin
- H3633204 - 80mm Satin



## Olympus Architectural Locks

### OVAL PROFILE SASHLOCK CASE



Depth 63 or 76mm  
Height 108mm  
Forend 152 x 25.5mm  
Centres 47mm

Backset  
63mm Case = 43mm  
76mm Case = 57mm

H3640002 - 63mm Brass  
H3640004 - 63mm Satin  
H3640102 - 76mm Brass  
H3640104 - 76mm Satin

### OVAL PROFILE FULL CASE DEADLOCK

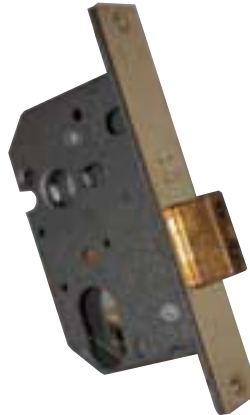

Depth 63 or 76mm  
Height 108mm  
Forend 152 x 25.5mm  
Centres 47mm

Backset  
63mm Case = 43mm  
76mm Case = 57mm

H3640402 - 63mm Brass  
H3640404 - 63mm Satin  
H3640502 - 76mm Brass  
H3640504 - 76mm Satin

### OVAL PROFILE SMALL CASE DEADLOCK

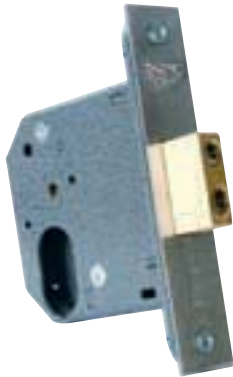

Depth 63 or 76mm  
Height 108mm  
Forend 152 x 25.5mm  
Centres 47mm

Backset  
63mm Case = 43mm  
76mm Case = 57mm

H3640202 - 63mm Brass  
H3640204 - 63mm Satin  
H3640302 - 76mm Brass  
H3640304 - 76mm Satin

### REBATE SETS FOR EURO & OVAL PROFILE LOCKS

H3650002 - 13mm Sashlock Brass  
H3650004 - 13mm Sashlock Satin  
H3650102 - 13mm Full Case Deadlock Brass  
H3650104 - 13mm Full Case Deadlock Satin  
H3650202 - 13mm Full Case Latch Brass  
H3650204 - 13mm Full Case Latch Satin  
H3650302 - 25mm Sashlock Brass  
H3650304 - 25mm Sashlock Satin  
H3650402 - 25mm Full Case Deadlock Brass  
H3650404 - 25mm Full Case Deadlock Satin  
H3650502 - 25mm Full Case Latch Brass  
H3650504 - 25mm Full Case Latch Satin

\*For Small Case Dead Locks use Rebate Sets Shown with 5 Lever Locks on Page 382 I.

LOCKS

## Oval Profile Cylinders

### SINGLE CYLINDER



H3641002 - 40mm Brass  
H3641102 - 45mm Brass  
H3641004 - 40mm Satin  
H3641104 - 45mm Satin

### DOUBLE CYLINDER



H3642002 - 60mm Brass  
H3642102 - 70mm Brass  
H3642202 - 80mm Brass  
H3642004 - 60mm Satin  
H3642104 - 70mm Satin  
H3642204 - 80mm Satin

### CYLINDER & THUMBTURN



H3643002 - 60mm Brass  
H3643102 - 70mm Brass  
H3643202 - 80mm Brass  
H3643004 - 60mm Satin  
H3643104 - 70mm Satin  
H3643204 - 80mm Satin

**Olympus Architectural Hinges**

**CLASS 8 BALL BEARING HINGES**



- H0442702 - 102x76x3mm Polished Brass
- H0442703 - 102x76x3mm Polished Stainless Steel
- H0442704 - 102x76x2.5mm Satin Stainless Steel
- H0442711 - 102x102x3mm Satin Stainless Steel
- H0442714 - 102x76x3mm Satin Stainless Steel

**CLASS 9 SELF LUBRICATING HINGES**



- H0442803 - 102x76x3mm Polished Stainless Steel
- H0442804 - 102x76x3mm Satin Stainless Steel

**PROJECTION HINGES**



- H8001032 - 102x102mm Polished Brass
- H8001033 - 102x125mm Polished Brass
- H8001034 - 102x152mm Polished Brass

**COUNTER FLAP HINGES**



- H8011031 - 102x32x3mm Polished Brass

**SINGLE ACTION SPRING HINGES**



- H8700001 - 75mm Silver
- H8700002 - 102mm Silver
- H8700003 - 127mm Silver
- H8700004 - 152mm Silver
- H8700005 - 178mm Silver
- H8300101 - 75mm Brass
- H8300102 - 102mm Brass
- H8300103 - 127mm Brass
- H8300104 - 152mm Brass

**DOUBLE ACTION SPRING HINGES**

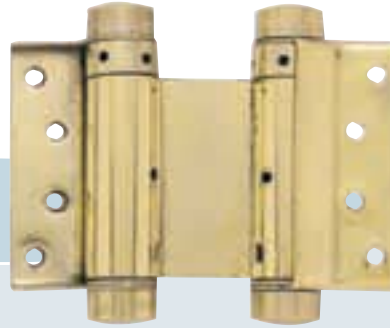

- H8700011 - 76mm Silver
- H8700012 - 102mm Silver
- H8700013 - 127mm Silver
- H8700014 - 152mm Silver
- H8700015 - 178mm Silver
- H8300111 - 76mm Brass
- H8300112 - 102mm Brass
- H8300113 - 127mm Brass
- H8300114 - 152mm Brass

Hinges

## Olympus Automatic Door Openers

The Olympus automatic door opener provides easy access for all users whether they are elderly, disabled or simply have no free hands to operate the door. With its built in safety devices the Olympus opener enables everybody safe access to the facilities within helping the building to comply to the disability discrimination act.

Two types of opener are available for use on hinged and sliding doors. For hinged doors openers can control the smooth opening and closing of doors up to a maximum width of 1200mm wide and 250kg in weight, whilst the unit for sliding doors will control doors up to a weight of 40kg.



### DOMESTIC OPENER

P6881001  
Up to 90 Kilos



### COMMERCIAL OPENER

P6881002  
Up to 250 Kilos



### SLIDING OPENERS

P6881000  
Up to 40 Kilos



### ARTICULATED ARMS

For outward opening  
P6881041 - Domestic  
P6881043 - Commercial

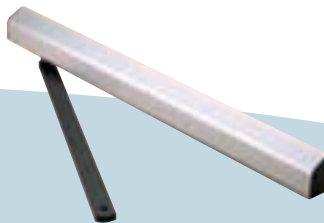

### SLIDING ARMS

For inward opening  
P6881040 - Domestic  
P6881045 - Commercial



### RECESSED ARM

Used for entrance door recessed under a lintel  
P6881042 - Domestic  
P6881044 - Commercial

### SAFETY FEATURES

#### ANTI CRUSH DEVICE

If the door should meet an obstruction, on opening or closing, it will return to either the open or closed position before slowly trying to operate the door once more to detect if the obstruction is still there. If the obstruction is still there it will repeat the process once more before stopping until it is manually closed or opened. If the obstruction moved it will complete its closing or opening cycle.

#### BATTERY BACKUP

A rechargeable battery backup feature is incorporated into the opener ensuring operation in the event of a power failure



### NECK EXTENSION KIT

P6881011 - Neck Extension Kit

# Olympus Automatic Door Openers

## ACTIVATING DEVICES

### PUSH & GO

In its simplest form the opener can be fitted and operated by a slight push of the door (once unlocked) which will activate the opener.

The opener can however be operated by a range of activating devices such as remote key fobs, push buttons and infra red activators as shown below as well as being linked with other access products shown in the access section on page 447.

### SELF PROGRAMMING RECEIVER



P6881009

### KEY FOB TRANSMITTER



P6881010

### MECHANICAL PUSH PAD



P6881008

### LARGE PUSH PAD WITH LOGO



P6881007

### P.I.R. SENSOR



P6881005 - Domestic  
 P6881006 - Commercial

### TOUCH SENSITIVE SWITCH



P6881048

### PROXIMITY READER



P6881046  
 Proximity Cards  
 P6881047 - Pack of 5

### PRESSURE MATS



P6881015

Door Controls

For electric strike plates to operate with these openers please see page 447

## Olympus Mailsafe Postal Boxes

Designed to offer protection against arson attacks on businesses or homes. If a lighted object or petrol is put into the mailsafe postal box the integral fire extinguisher reacts dealing with the problem instantly. They are recommended for use with outward opening letterplates and the range now includes an external version. Constructed from sheet steel they are sealed against offending liquids (capacity 5 litres).

### CHUBBY

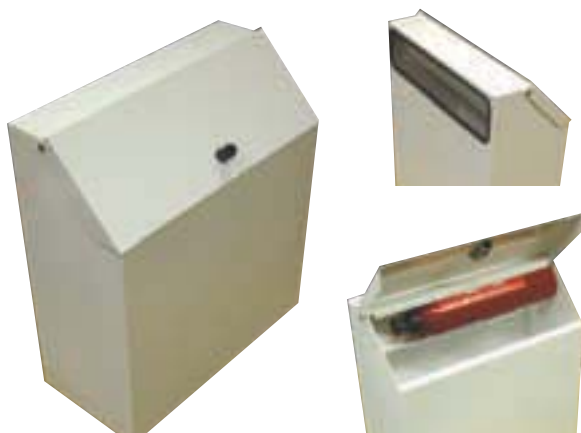

H0353001 - 380H x 320W x 150D

### SLIMLINE



H0353011 - 500H x 320W x 90D

### JUMBO



H035302 - 644H x 320W x 200D

### EXTERIOR WALL MOUNTED



H0353031 - 330H x 370W x 145D

### REPLACEMENT EXTINGUISHERS

H0353051



### POSTAL CHUTE FOR USE WITH JUMBO ONLY

H0353041



N&C

PHLEXICARE



# Ironmongery

With over 30 years experience within the healthcare industry, N&C Phlexicare are proud to have been entrusted in providing solutions to problems encountered by the elderly and disabled

For the Specifier, Contractor and end user, the following pages will help demonstrate our commitment to quality and innovation across a range of Ironmongery and Access products.

## Specialist Fittings Radar Locks

### RADAR LOCKSET POLISHED ALUMINIUM



**R.A.D.A.R Key Scheme**  
R.A.D.A.R. (The Royal Association for Disability and Rehabilitation) promotes a U.K. national scheme, whereby locks specially manufactured are fitted to toilets and can only be operated using a RADAR key. These keys are available to disabled or registered blind people to enable them to access the facilities. This aims to give protection against vandalism or misuse, so that a clean functional toilet is available.

**RADAR Lockset**  
A complete lockset comprising a 6 lever lock and engraved furniture which can be supplied polished aluminium (P.A.A.) and polished gold (P.G.), incorporating an external indicator and emergency coin release. All locksets are supplied with one bow shaped handle key and fixings.

**Handing**  
Only two hands are required, as the latchbolt can be easily reversed for inward or outward opening doors. To determine which hand is required, hand the lockset as follows:  
Standing inside the toilet  
If the hinges are on the Right you will need a R/H lockset  
If the hinges are on the Left you will need a L/H lockset

HO148502 - PAA R/H  
HO148503 - PAA L/H

### RADAR LOCKSET GOLD ANNOIDISED



HO148505 - PG R/H  
HO148506 - PG L/H

LOCKS

### RADAR KEYS



HO149001 - Standard Pattern  
HO149002 - Bow Handle Pattern

### COVER PLATES



Available to provide a contrast to aid visual impairment  
HO148504 - Red

Dimensions	Backset 50mm
Lock Case	Centres 60mm
Height 122mm	Internal and external plates
Depth 78mm	204 x 40mm
Width 15mm	Lever handle
Forend	
178 x 25mm	130mm long x 19mm diameter

### RADAR PADLOCK KEY SUPPLIED SEPARATELY



HO148501 - 64mm

### RADAR RIMLOCK KEY SUPPLIED SEPARATELY



HO148551 - 145 x 90mm L/H As Shown Above  
HO148552 - 145 x 90mm R/H

Further Details of These Products can be Found in the Phlexicare Catalogue

## Coloured Rails and Fittings

The Ponte Giulio range includes an extensive range of support rails, shower seats and accessories in a range of seven colours. Heavy Zinc Plated steel with a 3mm thick seamless nylon coating ensuring a warm comfortable and slip resistant grip.

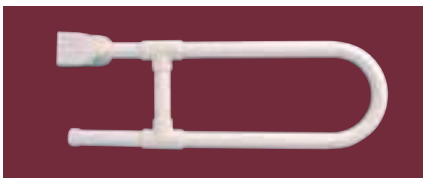

- Warm to touch
- Slip resistant
- Fully insulated
- Hygienic and easy to clean
- A range of seven striking colours

For further details on the products available within this range please look in the Phlexicare catalogue or ring our sales office.

Grab Rails

## Stepless Portable Ramps

DESIGNED FOR PERSONAL OR COMMERCIAL USE AND TO HELP MEET THE REQUIREMENTS FOR THE D.D.A THE STEPLESS RANGE CAN HELP TO SOLVE YOUR ACCESS PROBLEMS.

### PAIRS OF PORTABLE RAMPS

**PLAIN RAMP**



- P6433000 - 105cm
- P6433001 - 130cm
- P6433002 - 155cm
- P6433003 - 200cm

**TELESCOPIC RAMPS**



- P6433004 - 102cm
- P6433005 - 152cm
- P6433006 - 202cm
- P6433007 - 252cm
- P6433008 - 302cm

**FOLDING RAMP**



- P6433009 - 110cm
- P6433010 - 160cm
- P6433011 - 210cm
- P6433012 - 260cm
- P6433013 - 310cm

Ramps

### WIDE RAMPS

**PLAIN RAMP**

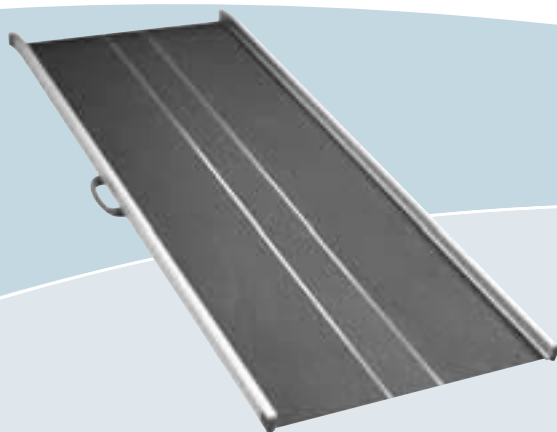

- P6433014 - 100cm
- P6433015 - 125cm
- P6433016 - 150cm
- P6433017 - 200cm
- P6433018 - 300cm

**FOLDING RAMP**

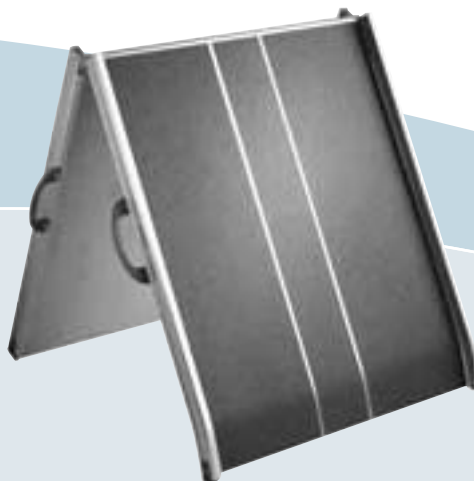

- P6433019 - 152cm
- P6433020 - 200cm
- P6433021 - 250cm
- P6433022 - 300cm

Further Details of These Products can be Found in the Phlexicare Catalogue



## Stepless Portable Ramps

### SUITCASE RAMPS

#### FOLDING RAMPS



- P6433025 - 92 x 76cm
- P6433026 - 122 x 76cm
- P6433027 - 153 x 76cm
- P6433028 - 183 x 76cm

#### TELESCOPE RAMPS



- P6433029 - 183 x 76cm
- P6433030 - 213 x 76cm
- P6433031 - 244 x 76cm
- P6433032 - 305 x 76cm

## Stepless Lifting Platforms

ELECTRICALLY OPERATED PLATFORMS IDEAL FOR USE IN AREAS WITH LIMITED SPACE



P6438001 - LP1  
P6438011 - LP4



P6438021 - LP6



P6438031 - LP12

#### SPECIFICATIONS

	LP1	LP4	LP6	LP12
MAXIMUM LIFTING HEIGHT	500mm	500mm	875mm	950mm
LIFTING CAPACITY	180kg	180kg	250kg	300kg
MINIMUM LIFTING HEIGHT	90mm	130mm	130mm	180mm

IT IS RECOMMENDED THAT MODEL LP6 IS EXPERTLY INSTALLED. FOR TECHNICAL ADVICE AND DETAILS OF OUR NATIONWIDE INSTALLATION SERVICE PLEASE CONTACT OUR SALES OFFICE.

FOR FULL SPECIFICATIONS ON THE STEPLESS RANGE OF PRODUCTS PLEASE SEE THE PHLEXICARE CATALOGUE

Ramps



## **Phlexicare Ramp Systems**

**ALTHOUGH PORTABLE RAMPS ARE SUITABLE FOR MANY SITUATIONS IN OTHER AREAS A MORE PERMANENT SOLUTION IS NEEDED.**

**WE OFFER A RANGE OF CUSTOM MADE RAMPS TAILORED TO SUIT YOUR PERSONAL REQUIREMENT.**



**A KIT SYSTEM OF RAMPS IS ALSO AVAILABLE WHICH CAN BE EASILY FITTED TOGETHER ON SITE AND TAKEN DOWN AND STORED AWAY WHEN NOT REQUIRED. MADE TO THE SAME SPECIFICATIONS AND QUALITY AS THE CUSTOM MADE RANGE.**

Further Details of These Products can be Found in the Phlexicare Catalogue

For more information go to [www.barbourproductsearch.info](http://www.barbourproductsearch.info)

**N&C Ironmongery**



# General Ironmongery

**N&C Building Materials continue to offer our customers the broadest range of hardware, tools and ancillary ironmongery. We show here our stock ranges as well as items that we will be pleased to order on your behalf.**

**N&C**  
Building Materials

## Information Page

The following information may be useful when reading this section of the catalogue.

If you should have a query that is not answered here or within the section please call our sales office for further assistance.

### ABBREVIATIONS USED FOR FINISHES

- BMA BRONZE METAL ANTIQUE
- CP CHROME PLATED
- EB ELECTRO BRASSED
- GAA GOLD ANODISED ALUMINIUM
- NP NICKEL PLATED
- IBMA IMITATION BRONZE METAL ANTIQUE
- PAA POLISHED ANODISED ALUMINIUM
- PB POLISHED BRASS
- PSS POLISHED STAINLESS STEEL
- PVD POLISHED BRASS WITH 25 YEAR FINISH WARRANTY
- SAA SATIN ANODISED ALUMINIUM
- SB SATIN BRASS
- SCP SATIN CHROME PLATED
- SSS SATIN STAINLESS STEEL
- ZP ZINC PLATED



### CARE OF FINISHES

Regular dusting and wiping with warm soapy water should be sufficient to keep finishes in their original condition for long periods. Extra cleaning for certain finishes should be carried out as shown below.

### POLISHED AND LAQUERED FINISHES

Use a good quality wax polish, particularly on externally fitted items, every two weeks. It should be noted that the life of a lacquer on most items is limited and will eventually break down. Adverse conditions such as industrial pollution, sea air, acid rain, abrasion etc or repeated continual handling may cause the coating to deteriorate prematurely. Therefore unless otherwise stated the life of a lacquer coating cannot be guaranteed.

### PLATED-REAL BMA-ANODISED FINISHES

An occasional wipe with a cloth dampened with a good quality light oil or lanolin is recommended.

### MORTICE LOCK CASE DIMENSIONS

The diagram below explains the terms used when showing the dimensions of lock cases throughout this catalogue.

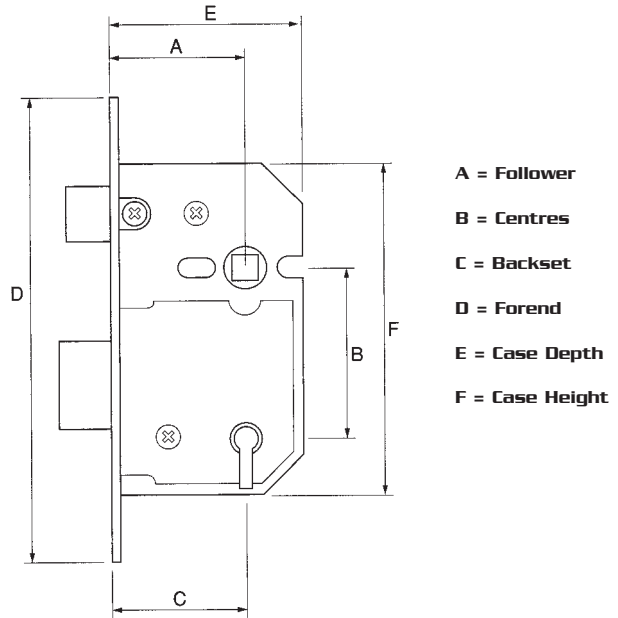

### DOOR CLOSER POWER SIZES

The table below shows the power sizes for door closers and the maximum door widths that they should be used with.

- POWER SIZE 2 MAXIMUM DOOR WIDTH 850MM
- POWER SIZE 3 MAXIMUM DOOR WIDTH 950MM
- POWER SIZE 4 MAXIMUM DOOR WIDTH 1100MM
- POWER SIZE 5 MAXIMUM DOOR WIDTH 1250MM
- POWER SIZE 6 MAXIMUM DOOR WIDTH 1400MM

Please note that when using door closers with either of the push side application brackets a power loss will be incurred. you are advised therefore that when using the fig 66 transom mounted bracket you should increase by 1 power size and when using the fig 66 parallel arm bracket by 2 power sizes.

e.g. door width 950mm:

- Using fig 1 regular bracket you would require power size 3
- Using fig 61 transom mounted bracket you would require power size 4
- Using fig 66 parallel arm bracket you would require power size 5.



## Ambassador Suite

### LEVER LOCK SET



152mm x 38mm  
HO287501 - SAA

### LEVER LATCH SET

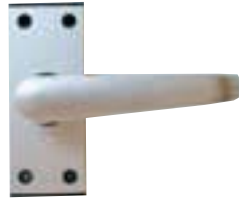

95mm x 38mm  
HO288001 - SAA

### BATHROOM SET REVERSIBLE



152mm x 38mm  
HO288501 - SAA

### LEVER ON ROSE



51mm Diameter  
HO289001 - SAA

## Renown Suite

### LEVER LOCK SET



152mm x 41mm  
HO293501 - SCP  
HO293502 - P.B.  
HO293505 - I.B.

### LEVER LATCH SET



73mm x 41mm  
HO294001 - SCP  
HO294002 - P.B.  
HO294005 - I.B.

### BATHROOM SET REVERSIBLE



152mm x 41mm  
HO294015 - SCP  
HO294016 - P.B.  
HO294017 - I.B.

## Gallery Suite

### LEVER LOCK SET



150mm x 42mm  
H9999909 - SAA

### LEVER LATCH SET



79mm x 42mm  
H9999908 - SAA

### BATHROOM SET



150mm x 42mm  
H9999910 - SAA R/H  
H9999911 - SAA L/H  
R/H ILLUSTRATED



## Kensington

### LEVER LOCK SET



170mm x 47mm  
 H9999935 - PVD Brass  
 H9999934 - CP  
 H9999933 - PB

### LEVER LATCH SET



170mm x 47mm  
 H9999932 - PVD Brass  
 H9999931 - CP  
 H9999930 - PB

### BATHROOM SET REVERSIBLE



170mm x 47mm  
 H9999938 - PVD Brass  
 H9999937 - CP  
 H9999936 - PB

NB: PVD Coating comes with a 25Yr Finish Guarantee

## Knob Furniture And Spindles

### CAST IRON BALL



44mm Diameter

H0320001 - Rim Fixing Japanned  
 H0320501 - Mortice Fixing Japanned

### CAST IRON OVAL KNOB



64mm

H0321001 - Rim Fixing Japanned  
 H0321501 - Mortice Fixing Japanned

### PLASTIC



44mm Diameter

H0322501 - Rim & Mortice Fixing  
 Brown

### ALUMINIUM BALL



44mm Diameter

H0324502 - Mortice Fixing  
 SAA

### SPINDLES

#### LOOSE PITTS SPINDLES

H0325001 - 86mm  
 H0325011 - 139mm



#### TAYLORS SPINDLES

H0325021



#### SPINDLE SLEEVES

To convert 5mm spindle  
 to 8mm  
 H0325031



## Anti Ligature Lock Furniture

Webb Lloyd Anti Ligature Furniture

Designed for use in areas where there is concern for safety such as hospitals and institutions for people with special needs

Can be used with either continental sized mortice locks or horizontal locks. No exposed fittings on the knob

Plate 60mm w x 200mm high for vertical lock cases

Plate 150mm w x 150mm high for horizontal lock cases

Bolt through fixing above and below the lock case

8mm Spindle

Available to suit latch, sash, nightlatch and escape locks.

Minimum of 72mm centres required on vertical lock cases

Knob is recessed in the plate to prevent anything being hung behind the knob

Anti vandal fixings available as an optional extra

Available to suit Euro and Oval Cylinders

Cylinders not provided





# Door Handles

**CAST IRON  
PULL HANDLE**



H0356001 - 152mm Black

**MALLEABLE IRON  
PULL HANDLE**



H0356501 - 178mm Black  
H0356502 - 178mm Galvanised

**BOW HANDLE**



H0357501 - 150mm SCP  
H0358001 - 150mm C.P.

**C.I. PULL HANDLE**



H0358501 - 152mm White

**PULL HANDLE**



H0359501 - 152mm C.P.

**PULL HANDLE**



H0360001 - 152mm SAA  
H0360011 - 184mm SAA

**BEST QUALITY  
DOOR HANDLE**



H0360501 - 230mm S.C.P  
H0360502 - 230mm PB

**CONTEMPORARY HANDLE**



H03640  
H0364011 - 305mm SAA

**DOOR HANDLE ON PLATE  
ENGRAVED PULL**



H0365501 - SAA 305x75mm  
Handle 227mm

Door Furniture

### Normbau Coloured Furniture

A versatile range of door furniture and bathroom fittings with a choice of fixings available as either solid nylon or steel cored for extra strength. Available to order in 17 colours



### Hewi Coloured Furniture

A wide variety of door fittings and bathroom furniture available to order in 8 colours.



For more information go to [www.barbourproductsearch.info](http://www.barbourproductsearch.info)

# Normbau

the design  
system  
specialist

for all your architectural  
hardware solutions



Available in the following colours:



CD0627

**IR** Normbau

**Pull Handles**

A RANGE OF PULL HANDLES FOR TIMBER/METAL OR GLASS DOORS AVAILABLE TO SPECIAL ORDER IN EITHER POLISHED OR SATIN STAINLESS STEEL IN SIZES SHOWN BELOW

**TYPE 60**



300 x 32mm

**TYPE 61**



300 x 38mm  
400 x 38mm

**TYPE 62**



354 x 25mm  
354 x 32mm  
424 x 32mm

**TYPE 63**



250 x 25mm  
300 x 32mm

**TYPE 64**



300 x 32mm  
450 x 32mm

**TYPE 65**



300 x 25mm  
300 x 32mm  
350 x 32mm

**TYPE 66**



450 x 32mm  
600 x 32mm

**TYPE 67**



450 x 25mm  
600 x 25mm  
450 x 32mm  
600 x 32mm

**TYPE 69**

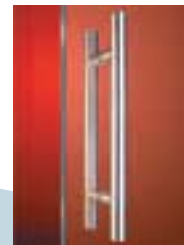

225 x 19mm  
300 x 32mm  
450 x 32mm  
600 x 32mm

**Fixing Options**

**DG - SINGLE DISC  
FIXING FOR  
GLASS DOOR**

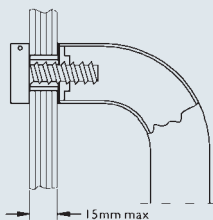

**BT - BOLT FIXING FOR  
TIMBER AND METAL  
DOORS**

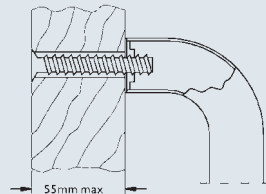

**SF - SURFACE FIXING  
FOR TIMBER METAL  
DOORS**

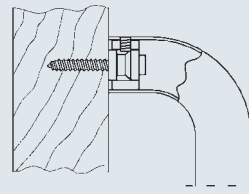

**BB - BACK TO BACK  
FIXING FOR TIMBER  
METAL &  
GLASS DOOR**

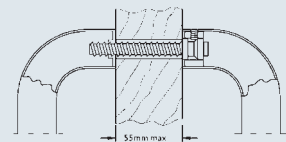

## Finger & kick Plates

AVAILABLE TO SPECIAL ORDER IN THE FOLLOWING MATERIALS SAA, POLISHED BRASS, SATIN STAINLESS STEEL POLISHED STAINLESS STEEL, CLEAR ACRYLIC AND SOLID COLOUR HIGH IMPACT POLYSTYRENE

ALL PLATES UNLESS OTHERWISE SPECIFIED ARE SUPPLIED DRILLED AND COUNTERSUNK WITH MATCHING SCREWS.

ALL PLATES CAN BE MADE IN A VARIETY OF THICKNESSES AND CAN BE MADE WITH RADIUS CORNERS AND POLISHED EDGES IF REQUIRED.

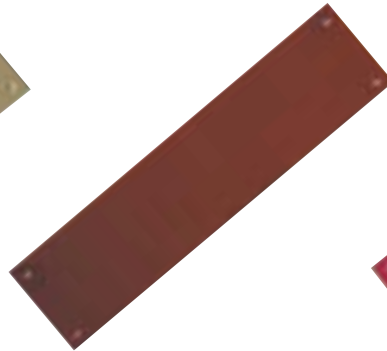

## Corner Protectors

### ALUMINIUM ANGLE 3 METRE LENGTHS

- H0387601 - 20 x 20 x 1.5mm
- H0387602 - 25 x 25 x 1.5mm
- H0387603 - 50 x 50 x 1.5mm

### PLASTIC ANGLE 2440MM LENGTHS

- H0387611 - 25mm x 25mm White
- H0387612 - 25mm x 25mm Black
- H0387613 - 50mm x 50mm White
- H0387614 - 50mm x 50mm Black

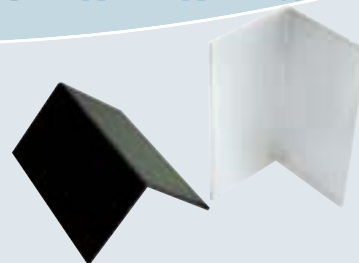
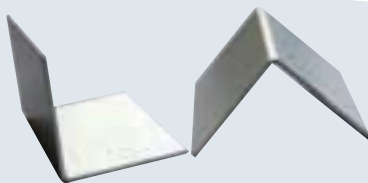

OTHER SIZES AVAILABLE TO ORDER



**Letter Plates**

**LETTER PLATE**



**H0340001** - Overall 268 x 76mm  
Opening 204 x 44mm  
Finish SAA

**H0340011** - Overall 330 x 76mm  
Opening 250 x 38mm  
Finish SAA

**LETTER PLATE**



**H0340501** - Overall 335 x 127mm  
Opening 295 x 76mm  
Finish SAA

**H0340511** - Overall 405 x 127mm  
Opening 330 x 75mm  
Finish SAA

**POSTAL PLATE SPRING ASSISTED**



**H0341001** - Overall 254 x 76mm  
Opening 203 x 44mm  
Finish SAA

**GRAVITY FLAP LETTER PLATE**



**H0341501** - Overall 257 x 76mm  
Opening 206 x 48mm  
Finish SAA

**POSTAL KNOCKER**



**H0342501** - Overall 268 x 76mm  
Opening 203 x 45mm  
Finish SAA

**INTERIOR FLAP**



**H0344001** - 250mm Finish SAA  
**H0344011** - 305mm Finish SAA  
**H0344021** - 355mm Finish SAA  
**H0344031** - 405mm Finish SAA

## Postal Boxes

### LETTER CAGE



305 H x 225 W x 127mm D

H0348501 - White Plastic Coated

H0348502 - Finish Brassed

### LETTER CAGE



450 H x 325 W x 205mm D

H0348551 - White Plastic Coated

H0348552 - Finish Brassed

### Alizee Junior



350 H x 360 W x 145mm D

H0353501 - White

H0353502 - Black

### MANOR



380 H x 250 W x 110mm D  
Rear Slot 230 x 30mm

H0353511 - Green

H0353512 - Black

### PICARDIE No 4



390 H x 250 W x 110mm D  
Rear Slot 230 x 30mm

H0353521 - White

H0353522 - Brown

### City 1



330 H x 370 W x 100mm D  
Letter plate 335 x 30mm

H0353531 - White -

H0353532 - Brown

### CITY 2



330 H x 260 W x 100mm D  
Letter plate 230 x 30mm

H0353541 - White

H0353542 - Brown

### CITY 3



330 H x 370 W x 100mm D  
Rear slot 350 x 45mm

H0353551 - White

H0353552 - Brown

### CITY 4



330 H x 260 W x 100mm D  
Rear Slot 240 W x 45mm

H0353561 - White

H0353562 - Brown

### LOCKABLE POSTAL CHUTE



H0352501

### FLAT LOCKING POSTAL



H0352001

### PURPOSE MADE BOXES



**Key Cabinets and Locking Medicine Cabinets**

**KEY CABINETS**



- 12 Key Capacity - h07825011
- 22 Key Capacity - H0782511
- 42 Key Capacity - H0782521
- 70 Key Capacity - H0782531
- 105 Key Capacity - H0782541



**PLASTIC KEY TAGS ASSORTED COLOURS**



**H0189601 Singles**  
Colours available - Red, Yellow, Black, White, Green, Blue, Orange, Mauve

Locking Cabinets

**LOCKING MEDICINE CABINETS**

611245 - 590 H x 370 W x 200 D



**H0782601**  
White

611251 - 590 H x 340 W x 125 D



**H0782611**  
White

611261 - 590 H x 340 W x 200 D



**H0782621**  
White

611271 - 590 H x 680 W x 200 D



**H0782631**  
White

## Self Adhesive Numerals

PLATE 35 x 35MM DIGITS 25MM



- (0) - H0700001
- (1) - H0700101
- (2) - H0700201
- (3) - H0700301
- (4) - H0700401
- (5) - H0700501
- (6) - H0700601
- (7) - H0700701
- (8) - H0700801
- (9) - H0700901

Finish SAA

PLATE 70 x 70MM DIGITS 50MM



- (0) - H0700011
- (1) - H0700111
- (2) - H0700211
- (3) - H0700311
- (4) - H0700411
- (5) - H0700511
- (6) - H0700611
- (7) - H0700711
- (8) - H0700811
- (9) - H0700911

Finish SAA

## Screw Fix Numerals

50MM WHITE PLASTIC



- (0) - H0720001
- (1) - H0720101
- (2) - H0720201
- (3) - H0720301
- (4) - H0720401
- (5) - H0720501
- (6) - H0720601
- (7) - H0720701
- (8) - H0720801
- (9) - H0720901

50MM BLACK PLASTIC



- (0) - H0720005
- (1) - H0720105
- (2) - H0720205
- (3) - H0720305
- (4) - H0720405
- (5) - H0720505
- (6) - H0720605
- (7) - H0720705
- (8) - H0720805
- (9) - H0720905

50MM SAA



- (0) - H0720002
- (1) - H0720102
- (2) - H0720202
- (3) - H0720302
- (4) - H0720402
- (5) - H0720502
- (6) - H0720602
- (7) - H0720702
- (8) - H0720802
- (9) - H0720902

50MM STAINLESS STEEL



- (0) - H0720004
- (1) - H0720104
- (2) - H0720204
- (3) - H0720304
- (4) - H0720404
- (5) - H0720504
- (6) - H0720604
- (7) - H0720704
- (8) - H0720804
- (9) - H0720904

Door Furniture

## Door Bells and Chimes

CLOCKWORK DOOR BELL



76mm Diameter  
H0349001

NEW INNOVATION CHIME

Requires No Batteries or Wires



H0349501

**Cabinet Fittings**

**ROLLED EDGE DRAWER PULL**



95mm

H0626001 - Polished Brass  
H0626002 - Chrome Plated

**FLUSH LIFTING HANDLE**



76 x 48mm

H0626501 - Polished brass  
H0626502 - Chrome Plated

**BRASS CARD FRAME**



H0627001 - 67 x 25mm  
H0627011 - 76 x 38mm

**ENGRAVED CARD FRAMES**

Up to 3 figures - special order only



150 x 75mm  
Card size 75 x 55mm  
H0629501 - SAA  
H0629502 - PAA  
H0629503 - P.B.

**CABINET HANDLE REAR FIXING**



H0640001 - 95mm SAA  
H0640002 - 95mm Polished Brass  
H0640003 - 95mm Chrome Plated  
H0640011 - 152mm SAA

Cabinet Fittings

**CONCAVE CUPBOARD KNOB BOLT FIXED**



H0642501 - 32mm Finish SAA  
H0642511 - 38mm Finish PAA

**STEEL CHEST HANDLE**



102mm  
H0659001 - Japanned



## Flush Handles

### FLUSH HANDLE WITH BAR



114 x 76mm

H0610001 - Black M.I.

### SQUASH COURT HANDLE



89 x 89mm, Depth 13mm

H0610501 - Polished brass

### FLUSH SPRING CATCH



51 x 38mm

H0611001 - Polished Brass

### FLUSH RING HANDLE



76 x 76mm

For use with clutch type sliding door locks

H0611501 - Polished brass

### FLUSH RING



H0612001 - 51 x 38mm Polished Brass  
H0612011 - 64 x 51mm Polished Brass

### FLUSH RING

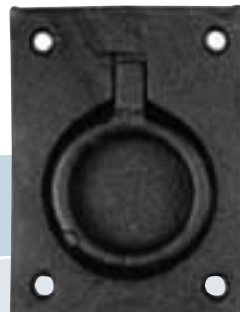

H0612051 - 89 x 64mm, Black Malleable Iron  
H0612061 - 102 x 76mm, Black Malleable Iron

**Door Stops and Holders**

**WALL MOUNTED  
DOOR STOP**



Concealed Fixing  
76mm Projection

H0560021 - SAA  
H0560031 - Polished Brass

**SOLID RUBBER  
DOOR STOP**

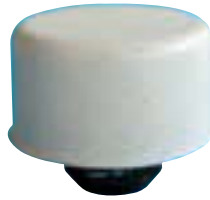

Concealed Fixing  
35mm Diameter

H0561501 - Off white

**FLOOR MOUNTED  
DOOR STOP**



Concealed Fixing  
For wood or concrete  
43mm diameter

H0562021 - SSS  
H0562031 - Polished Brass

**BLACK RUBBER  
DOOR STOP**



For Concrete  
38mm diameter  
H0562501

**BLACK RUBBER  
DOOR STOPS**



Screw Fix

H0563001 - 29mm  
H0563011 - 35mm  
H0563021 - 50mm

**WHITE RUBBER  
DOOR STOPS**

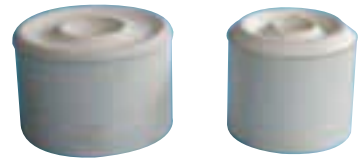

Screw Fix

H0563002 - 29mm  
H0563012 - 35mm

**FOOT OPERATED  
DOOR HOLDER**



190 x 44mm

H0564501 - Polished Brass

**FOOT OPERATED  
DOOR HOLDER**



134 x 57mm

H0565001 - Electro Brassed  
H0565002 - SCP

**BAYONET TYPE  
DOOR HOLDER**

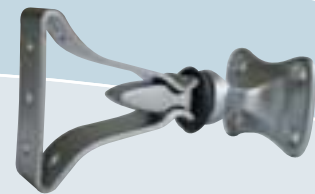

89mm

H0565501 - Polished Brass  
H0565502 - SCP

**RUBBER DOOR  
WEDGE 120MM**



H0563101 - Grey

**Cabin Hooks**

**CABIN HOOK & EYE**



**STRONG MALLEABLE IRON BLACK**

- H0570001 - 152mm
- H0570011 - 203mm
- H0570021 - 305mm

**CABIN HOOK & EYE**



**GALVANISED STEEL**

- H0570501 - 76mm
- H0570511 - 102mm
- H0570521 - 152mm
- H0570531 - 203mm

**CABIN HOOK & EYE**



**HOT PRESSED BRASS/STRONG POLISHED BRASS**

- H0571001 - 76mm
- H0571011 - 102mm
- H0571021 - 152mm

**CABIN HOOK & EYE**



**HOT PRESSED BRASS/STRONG SCP**

- H0571003 - 76mm
- H0571013 - 102mm
- H0571023 - 152mm

**CABIN HOOK & EYE**



**SILENT PATTERN HOT PRESSED BRASS POLISHED BRASS**

- H0571501 - 76mm
- H0571511 - 102mm
- H0571521 - 152mm
- H0571531 - 203mm
- H0571541 - 305mm

**CABIN HOOK & EYE**



**SILENT PATTERN HOT PRESSED BRASS SCP.**

- H0571503 - 76mm
- H0571513 - 102mm
- H0571523 - 152mm
- H0571533 - 203mm
- H0571543 - 305mm

Door Furniture

**CHECK CHAINS FIXED STAPLE ONE END D SHACKLE THE OTHER**



- H0572001 - 457mm Galvanised
- H0572011 - 610mm Galvanised
- H0572021 - 760mm Galvanised

**Strong Extruded Hooks**

**Cast Aluminium Quality Hooks**

**HAT & COAT HOOK**

**MATCHING WARDROBE HOOK**

**HAT & COAT HOOK**

**MATCHING WARDROBE HOOK**



115mm

38mm

128mm

43mm

H0581001 - SAA

H0581501 - SAA

H0582001 - SAA

H0582501 - SAA

**Buffered Hooks**

**Brass Hooks**

**HAT & COAT HOOK**

**MATCHING WARDROBE HOOK**

**HAT & COAT HOOK**

**MATCHING WARDROBE HOOK**



90mm

58mm

88mm

51mm

H0582031 - SAA

H0582021 - SAA

H0583001 - BMA  
H0583002 - CP

H0583501 - BMA  
H0583502 - CP

**Steel Wire Pattern Hooks**

**Strong General Purpose Hooks**

**HAT & COAT HOOK**

**HAT & COAT HOOK**

**ROBE HOOK**

**DOUBLE ROBE HOOK**



152mm

140mm

51mm

65mm

H0585001 - White

H0585502 - Black

H0586001 - Black

H0586502 - Black

**Multirack Hat & Coat Hooks**



SAA ON BLACK BASE  
 HEIGHT 45mm  
 HOOKS FIXED AT 150mm CENTRE  
 Projection 70mm

Single Hook Unit	H0587501	-	50mm
Two Hook Unit	H0587511	-	200mm
Three Hook Unit	H0587521	-	350mm
Four Hook Unit	H0587531	-	500mm
Five Hook Unit	H0587541	-	650mm
Six Hook Unit	H0587551	-	800mm
Connector Units	H0587561	-	100mm

UNITS CAN BE FIXED RAPIDLY & JOINED TOGETHER WITH CONNECTOR UNITS

**Handrail Brackets**

**STRONG STEEL  
 HANDRAIL BRACKET**



H0603501 - 51mm Zinc Plated  
 H0603511 - 64mm Zinc Plated  
 H0603521 - 76mm Zinc Plated

**MALLEABLE IRON  
 HANDRAIL BRACKET**



H0604001 - 64mm Black  
 H0604011 - 76mm Black

**STRONG STEEL  
 HANDRAIL BRACKET**



H0605001 - 51mm White  
 H0605011 - 64mm White  
 H0605012 - 76mm White

**BEST QUALITY HANDRAIL  
 BRACKET**



H0604501 - 64mm SAA  
 H0604511 - 76mm SAA

Hooks & Brackets



**Ventilators**

**VENT-A-MATIC WINDOW VENT**



**VENT-A-MATIC VENTILATORS**

Rotary Ventilators Controllable with Shutters

- H0746501 - Model 102 Aperture 121mm
- H0746502 - Model 106 Aperture 162mm
- H0746503 - Model SXL Aperture 219mm

Models with Stormguard

- H0746511 - Model C102S Aperture 121mm
- H0746512 - Model C106S Aperture 162mm

Rotary Ventilators Controllable with Shutters

- H0746521 - Model 101 Aperture 121mm
- H0746522 - Model 105 Aperture 162mm

**CIRCULAR VENTILATOR WITH GAUZE AT BACK**



- H0743002 - 75mm CP
- H0743012 - 102mm CP

**SOFFIT VENTILATOR**



600 x 150mm

H0744501 - Black

Ventilators

**HIT & MISS WINDOW VENTS**



2000mm<sup>2</sup> Vent area with fly screen  
H0535602 - 318 x 22mm White plastic

4000mm<sup>2</sup> Vent area with fly screen  
H0535612 - 538 x 22mm White plastic

**ADJUSTABLE SLOT WINDOW VENT**



2028m<sup>2</sup> Vent area 200 x 22mm  
H0535622 - White aluminium

4357m<sup>2</sup> Vent area 375 x 22mm  
H0535632 - White aluminium

**FLYMESH BRIGHT ALUMINIUM 2' WIDE**



Sold per foot  
Z9000015

**WHITE NYLON FLYMESH 450MM WIDE**



Sold per foot  
H4600217

**FLYMESH GREY PVC 4' WIDE**



Sold per foot  
Z9000018

**Cabinet Locks**

**BRASS CUPBOARD LOCKS**

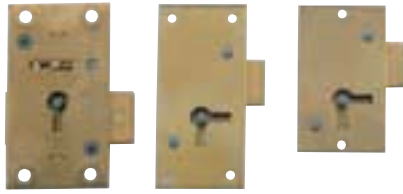

2 Keys 2 Lever NO Differs  
 H0020001 - 51 x 30mm Straight  
 H0020002 - 64 x 30mm Straight  
 2 Keys 3 Lever 12 Differs  
 H0020501 - 64 x 38mm Cut R/H  
 H0020502 - 64 x 38mm Cut L/H  
**UNION 4137**

**DRAWER LOCKS**



2 Keys 3 Lever 12 Differs  
 H0021002 - 64 x 48mm Brass

**BOX LOCK**



Lever 12 Differs  
 H0021501 - 64 x 38mm Brass

2  
Keys  
3



Cylinder Cut Cupboard/Drawer Lock  
 H0026201 64 x 38mm Brass



Cylinder Cut Cupboard/Till Lock  
 H0026202 64 x 38mm Brass



Cylinder Cupboard/Drawer Lock  
 H0026211 45 x 33mm Brass

**UNION 4148**



Cylinder Cupboard/Till Lock  
 H0026221 - 45 x 33mm Brass

**LOCKER LOCK**



For Steel Cabinets  
 H0023001 - 43 x 68mm

**BRASS THREAD ESCUTCHEONS**



H0330001 - 13mm  
 H0330011 - 14mm  
 H0330021 - 16mm

**TRIANGULAR KEY BUDGET LOCK**

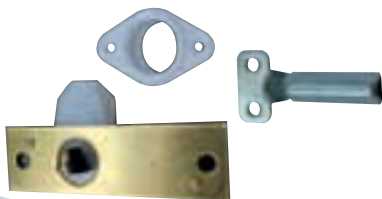

H4800018 - Lock and Ferrule  
 H4800020 - Long Keys to Suit

**MORTICE BUDGET LOCK**



H0044001 - Bright Zinc

**RIM BUDGET LOCK**



H0045501 - Bright Zinc

**ESCUTCHEONS FOR BUDGET LOCKS**



H0044501 - ZP

**SPRING ESCUTCHEONS FOR BUDGET LOCKS**



H0045001 - CP

**KEYS FOR BUDGET LOCKS**



H0046001

LOCKS

**Roller and Ball Catches**

**NYLON ROLLER DOOR CATCH**



NON ADJUSTABLE  
Plate 43 x 19mm  
Mortice 27 x 18mm  
H0029001 - White

**BRASS BALL CATCHES**



H0030001 - 6mm  
H0030002 - 8mm  
H0030003 - 10mm  
H0030004 - 13mm

**NYLON ROLLER DOOR CATCH**



ADJUSTABLE PRESSURE  
Plate 64 X 22mm  
Mortice 54 X 19mm  
H0029002 - White

**BRASS BALES CATCHES**



H0030501 - 10mm Ball Diameter  
Plate 32x14mm  
H0030502 - 13mm Ball Diameter  
Plate 45x19mm  
H0030503 - 17mm Ball Diameter  
Plate 57x22mm

**SELF ALIGNING CUPBOARD CATCH**



25 X 32mm  
H0029501 - Zinc Plated

**Brass Double Ball Catches**



H0031001 - 43mm  
H0031002 - 50mm  
H0031003 - 60mm  
H0031004 - 70mm

**Catches**

**Magnetic Catches**

**ROUND MORTICE TYPE**



For Medium Cupboard Doors  
17mm Diameter  
H0031501 - White

**SURFACE FIXING**



57 x 16mm  
Light to Medium 3 kg Pull  
H0032501 - White  
Medium to Heavy 4 kg Pull  
H0032502 - White

**Mortice Fixing**



63 x 16mm  
Normal Room Doors 6 kg Pull  
H0033001 - White

**SURFACE FIXING**



70 x 16mm Medium 6 kg Pull  
H0033501 - White  
45 x 16mm Light/Medium 4 kg Pull  
H0033502 - White  
45 x 16mm Light Cabinets 3 kg Pull  
H0033503 - White

**HUSH LATCH**



H0034501 - White

**TUTCH CATCH**



H0035501 - Zinc Plated

**Catches and Mortice Latches**

**SPRING CUPBOARD CATCH**



42 X 25mm  
H0036001 - Aluminium

**STEEL SPRING CATCH**



57 x 38mm  
H0037501 - Antique Copper  
H0038005 - Nickel Plated

**SLAM TYPE CATCH**



80 x 16mm  
H0038501 - SCP

**CUPBOARD BUTTONS**



51mm  
H0039001 - Zinc Plated

**HOLRO ROLLER CATCH**

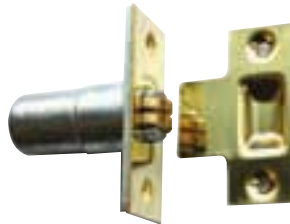

Mortice 51 x 19mm  
H0040001 - CP  
H0040002 - BRASS

**ROLLER BOLT CATCH**

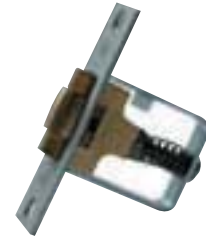

Mortice 51 x 35mm  
H0040501 - SS  
H0040502 - Brass

**LEGGE 3708 MORTICE LATCH**



64 X 38mm  
H0041501 NP

**LEGGE 3709 MORTICE LATCH**



76 x 38mm  
As 3708 but for use with separate locking Snib  
H0041502 NP

**LEGGE 14T LOCKING SNIB**



with emergency release  
For use with 3709 latch  
H0042001 - SS

**UNION 2677 MORTICE LATCH**

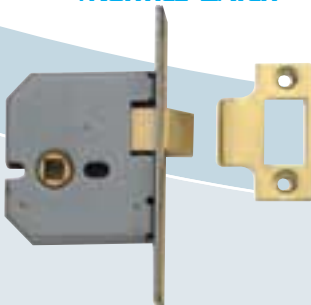

H0042501 - 64mm SCP  
H0042502 - 76mm SCP  
H0043001 - 64mm PB  
H0043002 - 76mm PB

REBATED FORENDS FOR UNION 2677 AND 2332

H0043101 - 12mm SCP  
H0043102 - 12mm Brass

**WATERLOO MORTICE LATCH**

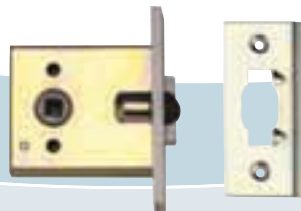

H0043501 - 70mm SAA

**BROADGATE MORTICE LATCH**



H0053501 - 63mm SS  
H0053502 - 63mm Brass  
H0053511 - 76mm SS  
H0053512 - 76mm Brass

REBATED FORENDS FOR BROADGATE LATCH

H0053521 - 12mm Silver  
H0053522 - 12mm Gold

Latches

**Union**

**UNION 2295  
2 LEVER SASH LOCK**



- H0060501 - 64mm CP
- H0060502 - 64mm Brass
- H0060511 - 76mm CP
- H0060512 - 76mm Brass

**UNION 2277  
3 LEVER SASH LOCK**



- H0066001 - 51mm SCP
- H0066002 - 51mm Brass
- H0066011 - 65mm SCP
- H0066012 - 65mm Brass

**UNION 2277  
3 LEVER SASH LOCK**



- H0066021 - 76mm SCP
- H0066022 - 76mm Brass
- H0066031 - 103mm SCP
- H0066032 - 103mm Brass

**UNION 2177  
3 LEVER DEAD LOCK**



- H0068001 - 65mm SCP
- H0068002 - 65mm Brass
- H0068011 - 76mm SCP
- H0068012 - 76mm Brass

**UNION 2294  
BATHROOM LOCK**



- H0063001 - 64mm CP
- H0063002 - 64mm Brass
- H0063011 - 76mm CP
- H0063012 - 76mm Brass

**UNION 2477  
SLIDING DOOR LOCK**



- H0068501 - 77mm SCP
- H0068502 - 77mm Brass

**UNION 2077  
HORIZONTAL MORTICE LOCK**

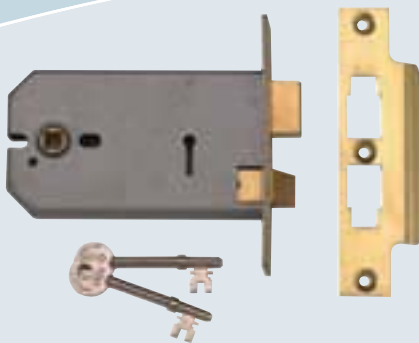

- H0067001 - 123mm SCP
- H0067002 - 123mm Brass
- H0067011 - 149mm SCP
- H0067012 - 149mm Brass

**2426 BATHROOM  
SLIDING DOOR LOCK**

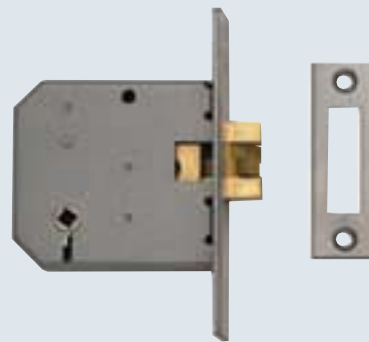

- H0063021 - 77mm SCP
- H0063022 - 77mm Brass



**Union**

**UNION L2241 OVAL CYLINDER  
SASH LOCK CASE**



- H0070001 - 65mm SCP
- H0070002 - 77mm SCP
- H0070011 - 65mm Brass
- H0070012 - 77mm Brass
- CYLINDER NOT SUPPLIED**

**UNION L2141 OVAL CYLINDER  
DEAD LOCK CASE**



- H0071001 - 65mm SCP
- H0071002 - 77mm SCP
- H0071011 - 65mm Brass
- H0071012 - 77mm Brass
- CYLINDER NOT SUPPLIED**

**2332/5203 CYLINDER  
NIGHTLATCH**



- H0070501 - 65mm SCP
- H0070502 - 77mm SCP
- H0070511 - 65mm Brass
- H0070512 - 77mm Brass
- SUPPLIED WITH CYLINDER & INSIDE TURN**

**2 x 1 B LENGTH  
OVAL PROFILE SINGLE CYLINDER**



- H0071501 - 45mm SCP
- H0071511 - 45mm Brass

**2 x 6 B LENGTH  
OVAL PROFILE DOUBLE CYLINDER**



- H0071502 - 74mm SCP
- H0071512 - 74mm Brass

**2 x 13 B LENGTH  
OVAL PROFILE CYLINDER & TURN**



- H0071503 - 74mm SCP
- H0071513 - 74mm Brass

Union Locks

**REBATE SETS ARE AVAILABLE FOR MOST OF THE UNION LOCK RANGE.  
PLEASE SPECIFY LOCK TYPE, REBATE SIZE AND FINISH WHEN ORDERING**

**Legge**

**8157XL MORTICE LATCH**



H0150202 - 76mm Brass  
H0150204 - 76mm SSS

**8157X SASH LOCK CASE**



H0150002 - 76mm Brass  
H0150004 - 76mm SSS

**8157X D DEAD LOCK CASE**



H0150102 - 76mm Brass  
H0150104 - 76mm SSS

**8157XB BATHROOM LOCK**



H0150302 - 76mm Brass  
H0150304 - 76mm SSS

**5641 BS DEAD LOCK**



H0151202 - 64mm Brass  
H0151204 - 64mm SSS

**5642 BS SASH LOCK**



H0151002 - 64mm Brass  
H0151004 - 64mm SSS

**8157XS SLIDING DOOR LOCK**



H0150402 - 76mm Brass  
H0150404 - 76mm SSS

**5762 BS SASH LOCK**



H0151102 - 76mm Brass  
H0151104 - 76mm SSS

**5761 BS DEAD LOCK**



H0151302 - 76mm Brass  
H0151304 - 76mm SSS

**LEGGE 2512 BATHROOM DEAD BOLT 5MM FOLLOWER**



H0152102 - 76mm Brass  
H0152104 - 76mm SSS

**REBATE SETS ARE AVAILABLE FOR MOST OF THE LEGGE RANGE OF LOCKS. PLEASE SPECIFY LOCK TYPE, REBATE SIZE AND FINISH WHEN ORDERING.**

**Chubb**

**CHUBB 36114 BS 3621**  
**MORTICE DEAD LOCK**

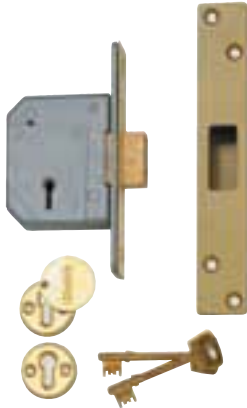

- H0077001 - 67mm Brass
- H0077002 - 67mm SCP
- H0077011 - 79mm Brass
- H0077012 - 79mm SCP

**CHUBB 36220**  
**MORTICE DEAD LOCK**



- H0080001 - 54mm Brass
- H0080002 - 54mm SCP

**CHUBB 36110 BS3621**  
**MORTICE DEAD LOCK**

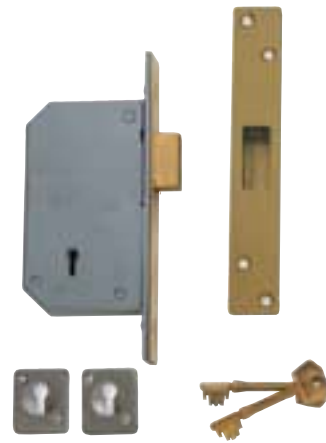

- H0081001 - 73mm Brass
- H0081002 - 73mm SCP

**CHUBB 36135 FORTRESS**  
**MORTICE DEAD LOCK**



- H0083501 - 73mm SCP

**CHUBB 3R35 MORTICE**  
**LOCKING LATCH**



- H0086501 - 80mm SCP L/H
- H0086502 - 80mm Brass L/H
- H0086511 - 80mm SCP R/H
- H0086512 - 80mm Brass R/H

**CHUBB 3R35X**  
**MORTICE LOCKING LATCH**



- H0088001 - 80mm SCP L/H
- H0088002 - 80mm Brass L/H
- H0088011 - 80mm SCP R/H
- H0088012 - 80mm Brass R/H

**CHUBB 3R35 FURNITURE**



- H0087501 - SAA L/H
- H0087511 - SAA L/H

**CHUBB 3R35 FURNITURE**

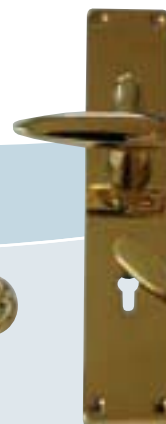

- H0087521 - Brass Reversible

**Chubb**

**CHUBB 3K70 Two Bolt MORTICE LOCK**



H0088501 - 73mm SCP  
H0088502 - 73mm Brass

**CHUBB 3K70/3K74 FURNITURE**



H0090001 - SAA

**CHUBB 3K70/3K74 FURNITURE**



H0090002 - Brass

**CHUBB 3K74 BS3621 Two Bolt MORTICE LOCK**

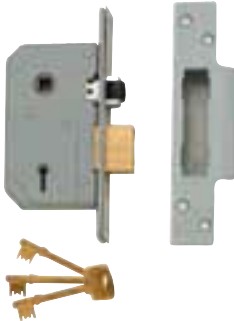

H0091001 - 67mm SCP  
H0091002 - 67mm Brass  
H0091011 - 80mm SCP  
H0091012 - 80mm Brass

**CHUBB 3J60 HORIZONTAL MORTICE LOCK**



H0093501 - 165mm SCP

**CHUBB 3M50 Hook Bolt MORTICE LOCK**

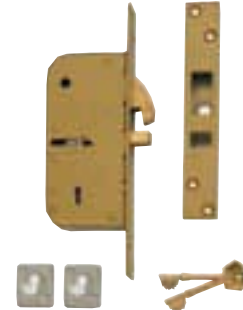

H0092501 - 70mm Gold

**REBATE SETS ARE AVAILABLE FOR MOST OF THE CHUBB RANGE. PLEASE SPECIFY LOCK TYPE, REBATE SIZE AND FINISH WHEN ORDERING.**

**Wellington**

**FORT 46B MORTICE LOCKING LATCH  
122 x 78MM 6 LEVER**



H0062501 - SAA L/H  
H0062502 - SAA R/H

**FORT 465B MORTICE LOCKING LATCH  
122 x 78MM 5 LEVER**



H0062510 - SAA L/H  
H0062520 - SAA R/H

**FORT 4H MORTICE DEAD LOCK  
120 x 78MM**



H0069501 - SAA

**N.B. BOTH OF THE ABOVE 46B LOCKS ARE SUPPLIED COMPLETE WITH SAA LEVER FURNITURE H0289001 AS SHOWN ON PAGE 397.**

## Mortice Locks

### BROADGATE HORIZONTAL MORTICE LOCK 3 LEVER

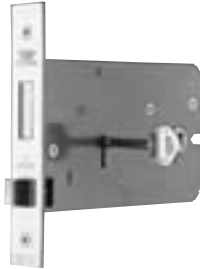

- H0052001 - 127mm SCP
- H0052002 - 127mm Brass
- H0052011 - 151mm SCP
- H0052012 - 151mm Brass

### BROADGATE SLIDING DOOR LOCK

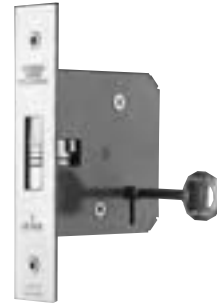

- H0051001 - 76mm SCP
- H0051002 - 76mm Brass

### ERA 5 LEVER BS SASH LOCK



- H0902070 - 64mm SCP
- H0902075 - 64mm Brass
- H0902080 - 76mm SCP
- H0902085 - 76mm Brass

### ERA 5 LEVER BS DEAD LOCK



- H0902050 - 64mm SCP
- H0902055 - 64mm Brass
- H0902060 - 76mm SCP
- H0902065 - 76mm Brass

## CISA Euro Profile Cylinders

### SINGLE CYLINDER 43MM



- H0071601 - NP
- H0071602 - PB
- H0071603 - CP

### DOUBLE CYLINDER 73MM



- H0071611 - NP
- H0071612 - PB
- H0071613 - CP

### CYLINDER AND TURN 73MM



- H0071621 - NP
- H0071622 - PB
- H0071623 - CP

## CISA Oval Profile Cylinders

### SINGLE CYLINDER 43MM



- H0071701 - NP
- H0071702 - PB
- H0071703 - CP

### DOUBLE CYLINDER 73MM



- H0071711 - NP
- H0071712 - PB
- H0071713 - CP

### CYLINDER AND TURN 73MM



- H0071721 - NP
- H0071722 - PB
- H0071723 - CP

CISA CYLINDERS ARE AVAILABLE IN OTHER SIZES TO ORDER AS WELL AS UNDER MASTER KEY AND KEYED ALIKE SYSTEMS



## Module 1200

The Module 1200 range is a complete architectural system offering lock cylinders and door furniture options. The locks are supplied with a 5.5.5. forend as standard but brass is available to special order. Furniture is available in either S.C.P. or polished brass finishes.

### SASHLOCK

Designed for main entrance doors or where latch control is required for normal use with a deadbolt locking security.

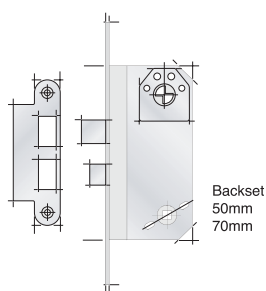

EXTERNAL	INTERNAL
Key operates deadbolt and latchbolt. Lever handle retracts latchbolt.	Thumbturn operates deadbolt and latchbolt. Lever handle retracts latchbolt.

- 1216**  
**H2900001**  
**Standard 50mm Backset**  
**H2900002**  
**Standard 70mm Backset**  
**1219**  
**H2900003**  
**High Security 50mm Backset**

### DEADLOCK

For entrance doors where no latch is required or for corridor or store doors.

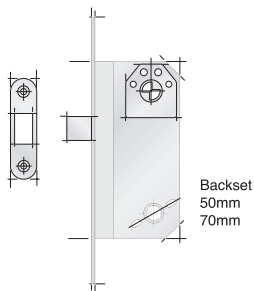

EXTERNAL	INTERNAL
Key operates deadbolt.	Thumbturn operates deadbolt.

- 1240**  
**H2900011**  
**Standard 50mm Backset**  
**H2900012**  
**Standard 70mm Backset**  
**1241**  
**H2900013**  
**High security 50mm Backset**

### LATCH

For internal doors where no deadlocking is required.

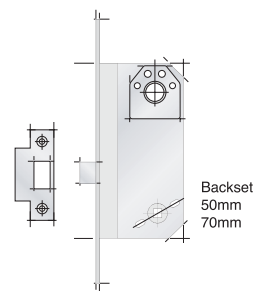

EXTERNAL	INTERNAL
Lever handle retracts latchbolt.	Lever handle retracts latchbolt.

- 1230**  
**H2900021**  
**50mm Backset**  
**H2900022**  
**70mm Backset**

### Bathroom Lock

For bathrooms and areas where a deadbolt indicator is required.

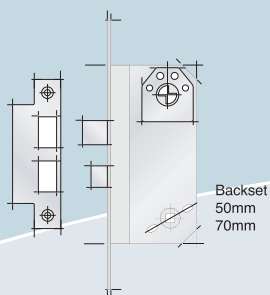

EXTERNAL	INTERNAL
Indicator rose with emergency device. Lever handle retracts latchbolt.	Thumbturn operates deadbolt, latch and indicator. Lever handle retracts latchbolt.

- 1216+1245**  
**H2900031**  
**50mm Backset**  
**H2900032**  
**70mm Backset**

### EMERGENCY NIGHTLATCH

For doors where emergency exit is required by lever handle.  
 Entry by key only

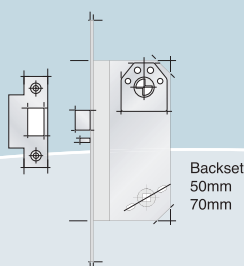

EXTERNAL	INTERNAL
Key operates latchbolt.	Thumbturn or lever handle offer free passage at all times.

- 1233**  
**H2900041**  
**50mm Backset**  
**H2900042**  
**70mm Backset**

### HOOKBOLT WITH LATCH

For use in areas where the maximum resistance to attack is required.

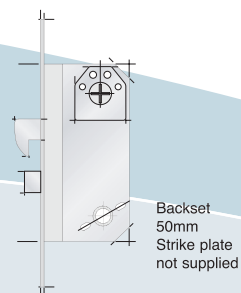

EXTERNAL	INTERNAL
Key operates hookbolt and latchbolt.	Thumbturn operates deadbolt and hookbolt. Lever handle retracts latchbolt.

- 1248**  
**H2900051**  
**50mm Backset**  
**Strike plate not supplied**

## Module 1200

### DEADLOCKING NIGHTLATCH

For use where automatic locking is required such as offices or cashrooms.

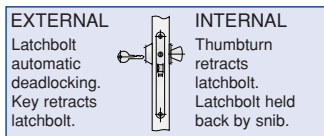
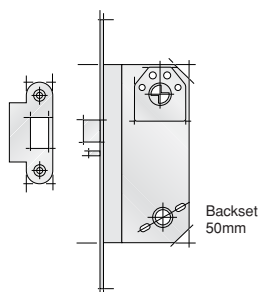

- With holdback snib - 1232
- H2900061**
- 50mm Backset**
- With holdback key snib - 1234
- H2900062**
- 50mm Backset**
- Without holdback - 1235
- H2900063**
- 50mm Backset**

### DOUBLE NIGHTLATCH

Designed for classrooms in schools & Universities as well as commercial premises and residential applications

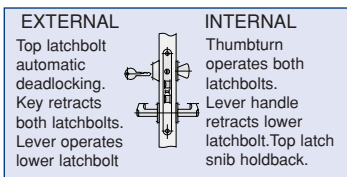
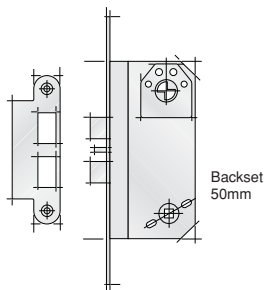

- With holdback snib - 1222
- H2900071**
- 50mm Backset**
- With holdback key snib - 1224
- H2900072**
- 50mm Backset**
- Without holdback - 1225
- H2900073**
- 50mm Backset**

### DOOR FURNITURE

Recommended for schools, hospitals and public buildings.

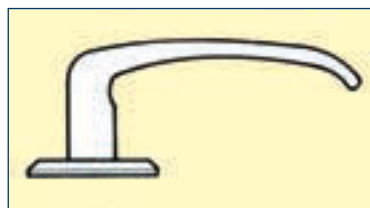

- H2900081**
- Unsprung SCP - 2640**
- H2900082**
- Unsprung Polished Brass - 2640**
- H2900083**
- Sprung SCP - 26440**
- H2900084**
- Sprung Polished Brass - 26440**

### DOOR FURNITURE

Recommended for schools, hospitals and public buildings.

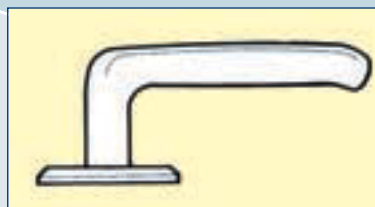

- H2900091**
- Unsprung SCP - 2696**
- H2900092**
- Unsprung Polished Brass - 2696**
- H2900093**
- Sprung SCP - 26696**
- H2900094**
- Sprung Polished Brass - 26696**

### CYLINDERS

Available to differ or master keyed



- H2900101**
- Nickel**
- H2900102**
- Brass**

### EXTENSION PIECE 2938

Extends cylinder length for thicker doors



- H2900111 - 8mm**
- H2900112 - 12mm**
- CYLINDER SCREW 2717**



- H2900121 - 28mm**
- H2900122 - 38mm**
- H2900123 - 48mm**
- FIXING SCREW 2949**

M5 fixing screws for handles & accessory sets adjustable on site. Requires fixing nipple.



- H2900131 - 50mm**
- H2900132 - 90mm**
- FIXING NIPPLE 58067**

For handles & accessory sets, use with fixing screw.



- H2900141**

**Module 1200 - Accessory Sets**

**2625**

Outside - Indicator Rose  
Inside - Thumbturn

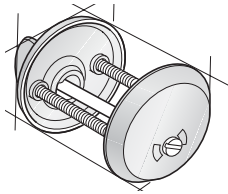

H2900151  
SCP  
H2900152  
Polished Brass

**2730**

Thumbturn supplied  
without spindle

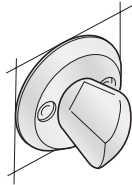

H2900161  
SCP  
H2900162  
Polished Brass

**2731/2**

Thumbturn follower with  
spindle 43mm

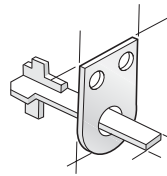

H2900171

**2944**

Outside - Cylinder Ring  
Inside - Thumbturn

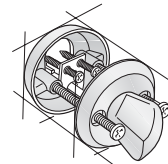

H2900181  
SCP  
H2900182  
Polished Brass

**2946**

Outside - Cylinder Ring  
Inside - Blind Rose

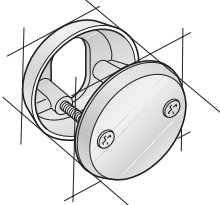

H2900191  
SCP  
H2900192  
Polished Brass

**2947**

Outside - Cylinder Ring  
Inside - Blind Rose

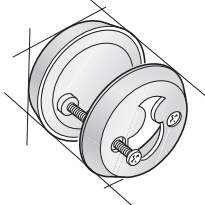

H2900201  
SCP  
H2900202  
Polished Brass

**2948**

Outside - Cylinder Ring  
Inside - Cylinder Ring

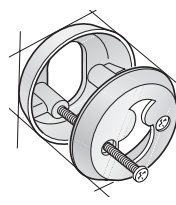

H2900211  
SCP  
H2900212  
Polished Brass

**2966**

Outside - Blind Rose  
Inside - Blind Rose

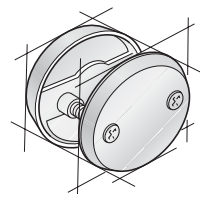

H2900221  
SCP  
H2900222  
Polished Brass

**2966I**

Inside - Blind Rose  
Replaces cylinder or lever

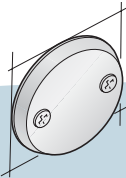

H2900231  
SCP  
H2900232  
Polished Brass

**2966E**

Outside - Blind Rose  
Replaces cylinder or lever

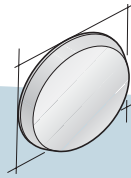

H2900241  
SCP  
H2900242  
Polished Brass

**2968**

External cylinder ring

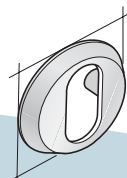

H2900251  
6mm SCP  
H2900252  
6mm Polished Brass  
H2900253  
8mm SCP  
H2900254  
8mm Polished Brass  
H2900255  
11mm SCP  
H2900256  
11mm Polished Brass  
H2900257  
13mm SCP  
H2900258  
13mm Polished Brass  
H2900259  
16mm SCP  
H2900260  
16mm Polished Brass  
H2900261  
18mm SCP  
H2900262  
18mm Polished Brass  
H2900263  
21mm SCP  
H2900264  
21mm Polished Brass  
H2900265  
24mm SCP  
H2900266  
24mm Polished Brass

**2969**

Internal Cylinder Ring

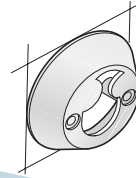

H2900271  
6mm SCP  
H2900272  
6mm Polished Brass  
H2900273  
8mm SCP  
H2900274  
8mm Polished Brass  
H2900275  
13mm SCP  
H2900276  
13mm Polished Brass  
H2900277  
18mm SCP  
H2900278  
18mm Polished Brass  
H2900279  
24mm SCP  
H2900280  
24mm Polished Brass



**Module 1200 - Assembly & Preparation**

Hardware

Architectural Lock System

**ASSEMBLY**

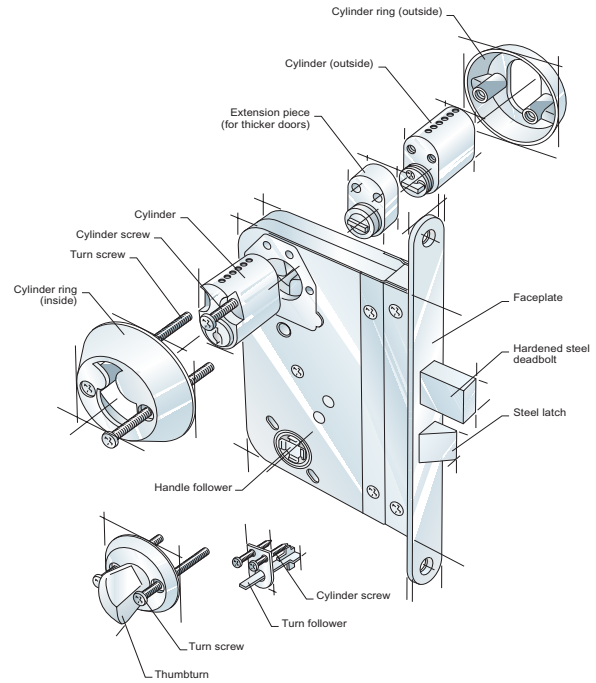
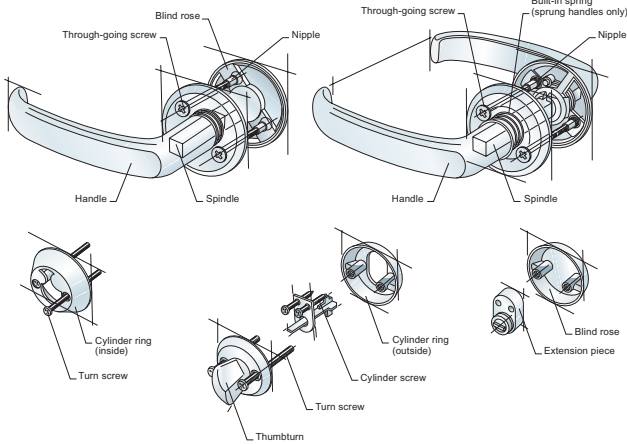

**ACCESSORY SETS**

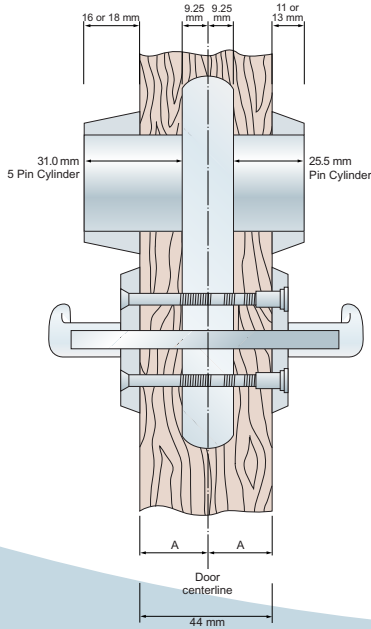

**DOOR PREPARATION**

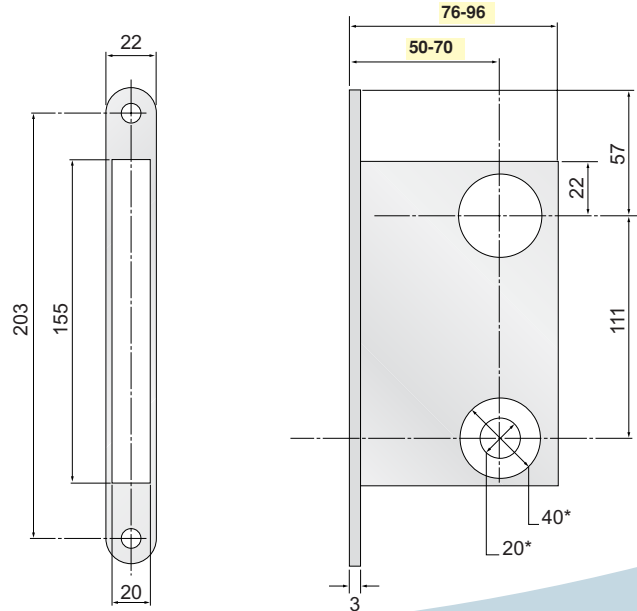

Standard Module 1200 accessory kits are available in four sizes and are designed to suit all scandinavian cylinder ranges. For non standard size doors a range of cylinder rings and extended screws may be supplied. Cylinder extension pieces are also available to enable the perfect fit of all components.

SIZE	ACCESSORY SET				For 44mm/45mm doors to suit cylinder
	2944	2946	2947	2948	
11mm	✓	✓	✓	✓	5 PIN
13mm (std)	✓	✓	✓	✓	5 PIN
16mm	✓	✓	✓	✓	6 PIN
18mm (std)	✓	✓	✓	✓	6 PIN

\* 20mm diameter cut-out required for surface fix door furniture.

\* 40mm diameter cut-out required for bolt through furniture.

If you are unsure please contact our technical desk.

N&C Building Products offer a full consultancy service from first design stage of the building through to final commissioning.

The Module 1200 range offers a five year return to base guarantee on mechanical operation where the product has been fitted to the manufacturers specification

**Rim Locks**

**WELLINGTON 50 RIM DEAD LOCK**  
4 LEVER 240 DIFFERS



102x 76mm  
HO180001 - Grey

**LEGGE 2144 RIM DEAD LOCK**  
2 KEYS 12 DIFFERS

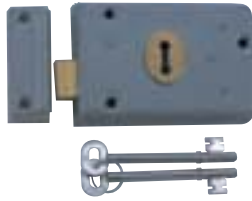

102 x 73mm  
HO181501 - Silver

**LEGGE 2098 UPRIGHT RIM LOCK**  
2 LEVER 12 DIFFERS



64 x 114mm  
HO182001 - Silver L/H  
HO182002 - Silver R/H

**LEGGE 2143 RIM LATCH**



102x 73mm  
HO181001 - Silver

**RIM LOCK**  
2 KEYS 12 DIFFERS



152 x 102mm  
HO183001 - Grey

**Nightlatches**

**YALE 77 CYLINDER RIM NIGHTLATCH**



92 x 65mm

HO184001 - Bronze Case Brass Cylinder  
HO184002 - Bronze Case SCP Cylinder

**YALE 706 CYLINDER RIM NIGHTLATCH FOR NARROW STILES**

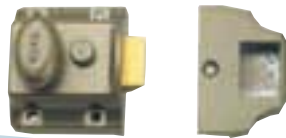

58 x 65mm

HO184021 - Bronze Case Brass Cylinder  
HO184022 - Bronze Case SCP Cylinder

**YALE LONG LIPPED STRIKEPLATE FOR OUTWARD OPENING DOORS**

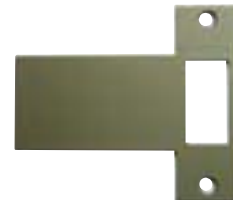

HO184011 - Bronze

**YALE 81 ROLLER BOLT NIGHTLATCH**



DEADLOCKED BY KEY OUTSIDE AND KNOB INSIDE  
92 x 70mm

HO186501 - Grey Case Brass Cylinder  
HO186502 - Grey Case SCP Cylinder

**YALE 82 CYLINDER RIM DEADLOCK**



DEADLOCKED BY KEY OUTSIDE AND KNOB INSIDE  
92 x 70mm

HO187002 - Grey Case Brass Cylinder  
HO187001 - Grey Case SCP Cylinder

**YALE 85 CYLINDER RIM NIGHTLATCH FOR NARROW STILES**



REVERSE TURN OF THE KEY DEADLOCKS THE BOLT AND INSIDE KNOB  
62 x 70mm

HO184501 - Grey Case Brass Cylinder  
HO184502 - Grey Case SCP Cylinder  
HO184503 - Brasslux Case Brass Cylinder



**Nightlatches and Rim Cylinders**

**YALE 88 CYLINDER RIM NIGHTLATCH**



DEADLOCKED INSIDE BY SNIB ONLY  
92x 70mm

- HO184521 - Grey Case Brass Cylinder
- HO184522 - Grey Case SCP Cylinder

**YALE 89 CYLINDER RIM NIGHT LATCH**



REVERSE TURN OF THE KEY DEADLOCKS BOLT FROM INSIDE KNOB  
92 x 70mm

- HO184511 - Grey Case Brass Cylinder
- HO184512 - Grey Case SCP Cylinder
- HO184513 - Brasslux Case Brass Cylinder

**YALE NO 1 AUTOMATIC DEADLOCKING NIGHT LATCH**

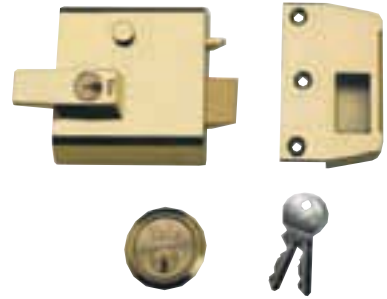

BOLT AND INSIDE KNOB DEADLOCKED WITH KEY FROM INSIDE  
92 x 88mm

- HO185511 - Grey Case SCP Cylinder
- HO185512 - Brasslux Case Brass Cylinder

**YALE NO 2 CYLINDER RIM DEADLOCKING NIGHT LATCH FOR NARROW STILES**

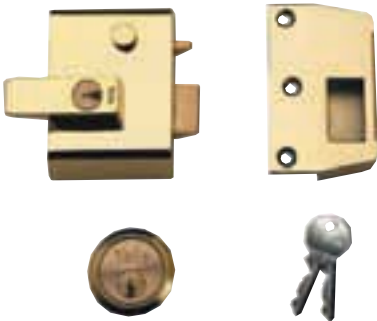

BOLT AND INSIDE KNOB DEADLOCKED WITH KEY FROM INSIDE  
64 x 88mm

- HO185501 - Grey Case SCP Cylinder
- HO185502 - Brasslux Case Brass Cylinder

**YALE PBS1 BS3621 NIGHT LATCH**



AUTO DEADLOCKING  
89 x 90mm

- HO185521 - Grey Case Brass Cylinder
- HO185522 - Brasslux Case Brass Cylinder

**YALE PBS2 BS3621 NIGHTLATCH FOR NARROW STILES**



AUTO DEADLOCKING  
69x 90mm

- HO185531 - Grey Case Brass Cylinder
- HO185532 - Brasslux Case Brass Cylinder

**YALE 1109 RIM CYLINDERS**

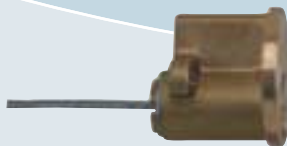

- HO188501 - Brass
- HO188503 - CP

**YALE CYLINDER KEY BLANKS**



- HO189001 - Nickel Silver

Rim Locks

# >> locks & hardware for the professional



making the choice for locks and hardware easy

>>

into the 21st century

UNION is one of the best known brands in the entire locking industry. For over a century, the name UNION and Locks and Hardware have been synonymous.

The UNION pedigree is built on experience, high standards, building relationships and, as a minimum, is always associated with reliable, high quality locks and hardware.

# UNION®

The professional's choice

## Nightlatches and Rim Cylinders

### UNION 1332 CYLINDER RIM DRAWBACK LOCK



92 x 76mm

- H0190001 - White Case Brass Cylinder
- H0190002 - White Case SCP Cylinder

### UNION 1334 CYLINDER RIM DRAWBACK LOCK



73 x 76mm

- H0190501 - White Case Brass Cylinder
- H0190502 - White Case SCP Cylinder

### ERA TRADITIONAL RIM NIGHTLATCH



92 x 66mm

- H0184005 - Bronze case Brass Cylinder

### CHUBB 4L67 GUARDIAN BS3621 RIM DEADLOCK

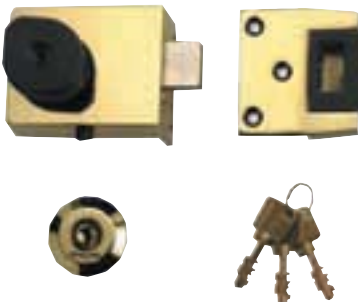

86 x 70mm

- H0084501 - Brass Case Brass Cylinder

### CHUBB 4L73 CYLINDER RIMLOCK

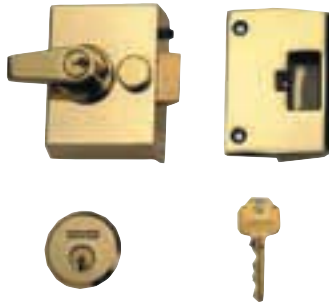

- H0085001 - Brass Case Brass Cylinder

### CHUBB 4LP CYLINDER PULL



- H0086001 - Brass

### 77LEGGE 707DL DEADLOCKING NIGHTLATCH

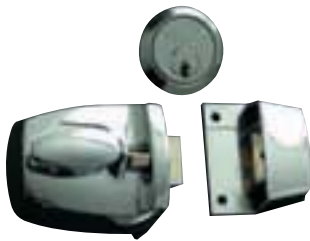

- H9999920 - PB Case PB Cylinder
- H9999922 - Silver Case SCP Cylinder
- H9999916 - CP Case SCP Cylinder

### LEGGE 727DL DEADLOCKING NIGHTLATCH NARROW STILE



- H9999836 - PB Case PB Cylinder
- H9999835 - Silver Case SCP Cylinder
- H9999921 - CP Case SCP Cylinder

### LEGGE B6 RIM CYLINDERS

### LEGGE 66 TRADITIONAL NIGHTLATCH



- H9999834 - Gold Case Brass Cylinder

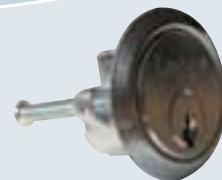

- H0159901 - SCP
- H0159902 - Brass

# Rim Locks



**Security Fittings**

**CHUBB W512 SECURITY HINGE BOLTS**



HO100001 - White Per Pair

**CHUBB W514 SECURITY HINGE BOLTS**



HO100011 BZP

**CHUBB W56 DOOR CHAIN**



HO100501 - SCP  
HO100502 - Brass

**CHUBB W58 DOOR VIEWER 130° ANGLE**



12mm Diameter

HO101001 - CP

**CHUBB W59 DOOR VIEWER 170° ANGLE**



27mm Diameter

HO101031 - CP

**CHUBB W513 DOOR VIEWER 130° ANGLE**



12mm Diameter

HO101021 - CP  
HO101022 - Brass

**CHUBB 8002 SECURITY BOLT**



For Doors or French Windows  
Plate 41 x 19 Depth 60mm

HO101501 - Brass  
HO101502 - White

**CHUBB 8001 SECURITY BOLT**



For Wooden Casement Windows  
Plate 41 x 19 Depth 32mm

HO102001 - Brass  
HO102002 - White

**CHUBB KEYS FOR SECURITY BOLTS**



HO101511 - 85mm Long Pair  
HO101512 - 114mm Long Each

**CHUBB W51 LOCKING WINDOW STOP**



HO102501 - Brass  
HO102511 - Keys Pair

**CHUBB 8K101 LOCKING WINDOW CATCH**



HO103001 - White  
HO103011 - Keys Pair

**CHUBB 8K102 WINDOW LOCK**



HO103501 - White  
HO103511 - Keys Pair

**Security Fittings**

**CHUBB 8013 DUAL  
LOCKING SCREW**



H0104001 - Brass

**CHUBB 8K104  
EASY FIT DUAL SCREW**



H0104011 - Brass  
H0104021 - Keys Pair

**CHUBB 8012 METAL  
WINDOW LOCK**



H0104501 - Gold  
H0104511 - Keys Pair

**CHUBB 8K100  
WINDOW LOCK**



H0105001 - White  
H0105011 - Keys Pair

**CHUBB 8K106  
WINDOW LOCK**



H0105501 - White  
H0105511 - Keys Pair

**CHUBB 8K107  
PATIO DOOR LOCK**



H0106001 - SCP

**CHUBB 8K109  
WINDOW LOCK**



H0106501 - White

**CHUBB 8K114  
WINDOW LOCK SUPPLIED WITH  
TWO KEYS**



H0107001 - White

**CHUBB 8K116 MULTI  
PURPOSE DOOR BOLT  
SUPPLIED WITH TWO KEYS**



H0108001 - White

**ERA 100.12  
PATIO DOOR LOCK**



H0110002 - White

**ERA 740 HINGE BOLTS**



H0110501 - Satin

**ERA 784 DOOR VIEWER  
180° ANGLE**



H0111001 - CP  
H0111002 - Brass

Security Fittings



**Security Fittings**

**ERA 786 DOOR VIEWER  
160° ANGLE**



**HO111011 - CP  
HO111012 - Brass**

**ERA 801 WINDOW LOCK**



**HO111501 - White**

**ERA 805  
MULTI PURPOSE BOLT**



**HO112501 - White**

**ERA 807  
MULTI PURPOSE BOLT**



**HO113001 - White**

**ERA 820 STAYLOCK**



**HO114001 - Satin Silver**

**ERA 822  
SASHLOCK**



**HO114501 - Satin silver**

**ERA 825  
TRANSOM LOCK**



**HO115001 - White**

**ERA 826 DUAL SCREW**



**HO115501 - Brass**

**ERA 902  
FLUSH PIVOT LOCK**



**HO121001 - White**

**ERA 720  
SECURISTAY**



**HO122001 - White**

**ERA 700  
SECURICHAIN**



**HO122501 - Satin CP  
HO122502 - Brass**

**Ultrascope  
Door Viewer**



**HO101041- Gold  
Also Available in Black & White  
Finishes**

Security Fittings

## Security Fittings

The fitting of security locks involves chiselling and removal of wood which weakens the door which can cause it to split open during a forced attack or kick in burglary. Kickstop products are designed to resist this type of attack. We show a few of these products below, but for further products details are available upon request.



# Security Fittings

### KICKSTOP HINGEGUARD

Fixed adjacent to hinge to strengthen frame against kick in attack  
Size 300 x 16 x 5mm

H0122601 - White 2618

### KICKSTOP DEADLOCK GUARD

Reinforces door around mortice locks available to suit, lever, euro or oval locks. Size 188 x 35 x 7mm

H0122602 - White 9600UK

### KICKSTOP STAPLEGUARD

Strengthens the frame around the staple of a cylinder nightlatch. Size 300 x 20 x 5mm Universal staple  
Size 30 x 70-97mm

H0122603 - White 2004

### KICKSTOP LONDON BAR

A door reinforcing bar with a D shaped staple to fit the internal face of the door on the lock side of a door fitted with a cylinder nightlatch.

Size 1830 x 16mm Universal staple 30 x 70 - 97mm

H0122701 - White 2009

### KICKSTOP BIRMINGHAM BAR

A dual purpose flat security bar to strengthen either the hinge side of the frame or the lockside where a mortice lock is fitted.

Size 1830 x 16mm

H0122702 - White 2614

OTHER PRODUCTS, SIZES AND FINISHES AVAILABLE TO ORDER

Security Fittings

Security Fittings

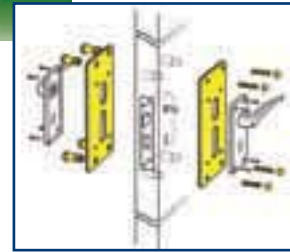

**KICKSTOP DOOR GUARD GRILLE**

A 5 bar Security Grille Folding Trellis  
Screw fixes to the upper or lower door to resist entry via  
glazed or weak panels. Size 1100 x 725 x 5mm

HO122801 - White D62

**KICKSTOP DOORGUARD BAR**

A single 5mm bar measuring 725x20mm used as door  
grille. Fit approximately 125mm apart.

HO122802 - White D61

**KICKSTOP SASHLOCK GUARD**

Strengthens the weakened area of a door where a  
mortice sashlock is fitted. Backset 27 - 47mm, Centres  
30 - 92mm. Size 240 x 75 x 3mm

HO122901 - White 9619

**KICKSTOP FRAMEGUARD**

Reinforces the frame adjacent to a mortice lock striking  
plate. Size 300 x 20 x 5mm

HO122902 - White 2002

**PRIKKA STRIP**

The Intruder Excluder

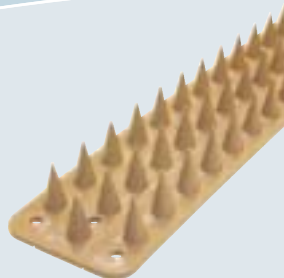

The effective low cost deterrent against unwelcome intruders. Fit to tops  
of fences, gates, pipes, walls & sills. Designed to deliver maximum  
discomfort but minimum harm, the unique double hinged design allows  
easy fixing to angled surfaces. 500x45mm strips can be screwed, nailed or  
glued. Check suitability of glues with polypropylene before gluing.

HO123001 - 4mtr pack

Contains 8 x 500mm strips and 1 warning notice.

Dimensions

Strips 500mm long 45mm wide 15mm high

**ROYDE AND TUCKER**

**SECURITY COWL**

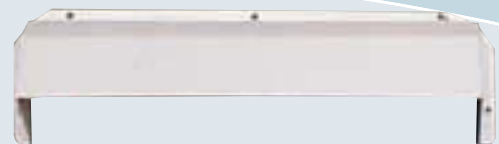

Obstructs view, prevents manipulation of locks  
and inhibits vandalism.

HO124001

## Squires Padlocks

### LAMINATED 6 LEVER PADLOCK OPEN SHACKLE



HO184601 - 70mm HS1  
HO184730 - 45mm HS2

### LION BRASS PADLOCKS



Standard Shackle  
HO184620 - LN3 30mm  
HO184621 - LN4 40mm  
HO184624 - LN5 50mm  
  
Long Shackle (Illustrated)  
HO184622 - LN4/2.5 40mm

### LEOPARD BRASS PADLOCK



Standard Shackle  
HO184631 - LP7 25mm  
HO184632 - LP8 30mm  
HO184633 - LP9 50mm  
HO184636 - LP10 60mm  
HO184637 - LP60 70mm  
Closed Shackle (Illustrated)  
HO184634 - LP9CS 30mm  
Stainless Steel Shackle  
HO184635 - LP9S 40mm

### LEOPARD PLASTIC COVERED BRASS PADLOCK



HO184638 - LP8CV 30mm

### OLD ENGLISH 4 LEVER PADLOCK GALVANISED STEEL



HO184640 - 220 38mm  
HO184641 - 440 51mm  
HO184702 - 660 64mm

### BRASS RUSTPROOF PADLOCK STAINLESS STEEL SHACKLE



HO184660 - 45SS 38mm

### STRONGLOCK LAMINATED PADLOCK



Standard Shackle  
HO184650 - No. 35 38mm  
HO184653 - No. 37 44mm  
HO184655 - No. 39 51mm  
Long Shackle  
HO184652 - 35/2.5 38mm  
Closed Shackle (Illustrated)  
HO184654 - 37CS 44mm  
HO184656 - 39CS 51mm

### KROMELOK RUSTPROOF PADLOCK



CP with Stainless Steel Shackle  
Standard Shackle (Illustrated)  
HO184680 - KR40 40mm  
HO184682 - KR50 50mm  
Closed Shackle  
HO184681 - KR40CS 40mm

### ARCTIC SOLID STAINLESS STEEL PADLOCKS



Closed Shackle  
HO184670 - ARC50CS 50mm

### ALL TERRAIN COLOURED PADLOCKS



HO184690 - AT L1 40mm  
HO184691 - AT L2 50mm

### COLOURED COMBINATION PADLOCK



Standard Shackle  
HO184720 - CP1 45mm

### BRASS COMBINATION PADLOCK



Standard Shackle  
HO184721 - CLL1 22mm  
HO184722 - CTL1 30mm

**Squires Padlocks**

**COLOURED LOCKER LOCK**



HO184761 - LL1 48mm

**RUCKSACK LOCK RECODEABLE**



HO184723 - RSL1

**DISCUS LOCK  
STAINLESS STEEL**



HO184731 - DCL1 70mm

**STRONGHOLD HIGH SECURITY  
PADLOCK**



Standard Shackle  
HO184740 - SS50S P5 50mm  
HO184744 - SS65S 65mm  
Closed Shackle  
HO184741 - SS50CSP5 50mm  
HO184771 - SS65CS 65mm  
Long Shackle  
HO184742 - SS50S/2.5 50mm

**SQUIRE HIGH SECURITY CHAIN**



Hardened Boron Alloy  
HO184781 - G3 915 x 10mm  
HO184782 - G4 1220 x 10mm  
HO184783 - G6 1800 x 10mm  
HO184784 - J3PR 915 x 8mm  
HO184785 - J4PR 1220 x 8mm  
HO184786 - J6PR 1800 x 8mm

Hardened Steel 6.5mm  
HO184791 - CP36PR 900 x 6.5mm  
HO184792 - CP48PR 1200 x 6.5mm

**SQUIRE  
SECURITY CABLE**



15mm Thickness

HO184801 - 8C 1800 x 8mm  
HO184802 - 15CPR 1800 x 15mm

**SQUIRES ZENITH 12  
HEAVY DUTY CABLE LOCK**



HO184811 - ZR12/1800 1800mm

**SQUIRES ZENITH 12 COMBI  
HEAVY DUTY CABLE LOCK**



HO184821 - ZR12COMB 1800mm

**SQUIRE 116 CABLE LOCK**



HO184831 - 116 1800mm

**SQUIRE BRASS COMBI  
BOLT**



Recodeable Combination Lock

HO184841 COMBI1



**Padlocks**

**CHUBB IK11 BATTLESHIP  
CLOSE SHACKLE PADLOCK  
3 KEYS 6 LEVER**



**HO096001 - 65mm Painted**

**CHUBB IK21 CRUISER  
CLOSE SHACKLE PADLOCK  
2 KEYS 5 LEVER**



**HO096501 - 74mm Painted**

**CHUBB IK57 HERCULES  
3 KEYS 10 DISC RETAINER  
AVA MECHANISM PADLOCK**



**HO097001 - 107 x 70mm**

**CHUBB IK12A CONQUEST  
CLOSE SHACKLE PADLOCK  
3 KEYS**



**HO097502 - 97 x 68mm Painted**

**CHUBB IK13C CONQUEST  
EXTRA CLOSE SHACKLE  
PADLOCK 2 KEYS**



**HO097512 - 111 x 68mm Painted**

**CHUBB IK22A CONQUEST  
OPEN SHACKLE PADLOCK  
2 KEYS**



**HO097514 - 115 x 68mm Painted**

**CHUBB IK42  
OPEN SHACKLE PADLOCK**



**HO097511 - 51mm**

**BROADGATE LAMINATED  
PADLOCK 2 KEYS**



**HO161001 - 30mm ZP  
HO161002 - 40mm ZP  
HO161003 - 50mm ZP  
HO161004 - 60mm ZP**

**BROADGATE BRASS  
PADLOCK 2 KEYS**



**HO161501 - 20mm Brass  
HO161502 - 25mm Brass  
HO161503 - 30mm Brass  
HO161504 - 40mm Brass  
HO161505 - 50mm Brass  
HO161506 - 60mm Brass**

**BROADGATE HIGH  
SECURITY PADLOCK  
2 KEYS 5 LEVER**



**HO162001 - 67mm Grey**

Security Fittings

**Locking Bars**

**SQUIRE NO 8 STEEL  
HASP & STAPLE**



**HO184750 - 216mm**

**SQUIRE NO 6H STEEL  
HASP & STAPLE**



**HO184751 - 153mm**

**SQUIRE NO 45MC STEEL  
HASP & STAPLE**



**HO184752 - 113mm**

**SQUIRE LB1 HEAVY DUTY  
SECURITY BRACKET**



**HO184753 - 166mm**

**SQUIRE LH1 LOCKING HASP  
ZINC PLATED**



**HO184754 - 152mm**

**SQUIRE STH2 CEN 4 HASP  
& STAPLE HIGH SECURITY**



**Black Powder Coated**

**HO184755 - 184mm**

**SQUIRE STH1 CEN 6 HASP &  
STAPLE HIGH SECURITY**



**Black Powder Coated**

**HO184756 - 184mm**

**SQUIRE HLS505  
CEN 5 LOCKSET**



**Zinc Plated**

**HO184757 - 150mm**

**SQUIRE LB2CS  
HASP & STAPLE**



**Black Powder Coated**

**HO184758 - 166mm R/H  
HO184759 - 166mm L/H**

**CHUBB 7B018 HERCULES  
PADLOCK BAR**



**HO098001 - 276 x 80mm**

**CHUBB 7007  
HORIZONTAL PADBAR**



**HO098501 - 321 x 63mm**

**CHUBB 7009  
UPRIGHT PADBAR**



**HO099001 - 184 x 140mm**

## Locking Bars

### CHUBB 7B020 CONQUEST PADBAR



HO099003 - 101 x 228mm

### BROADGATE LOCKING BAR



HO162501 - 203 x 63mm

### STRONG MALLEABLE IRON VERTICAL HASP & STAPLE



HO168511-152 x 127mm Japanned

### STRONG STEEL LOCKING BAR



HO165001 - 203mm Japanned  
HO165002 - 254mm Japanned  
HO165011 - 203mm Galvanised  
HO165012 - 254mm Galvanised

### STRONG MALLEABLE IRON LOCKING BAR TO SWIVEL



HO166001 - 254mm Japanned  
HO166002 - 305mm Japanned  
HO166003 - 354mm Japanned  
HO166004 - 457mm Japanned

### EXTRUDED HASP & STAPLE



HO167001 - 76 x 25mm Polished Brass  
HO167002 - 102 x 35mm Polished Brass

### STRONG STEEL HASP & STAPLE



HO167501 - 76mm Zinc Plated  
HO167502 - 114mm Zinc Plated  
HO167503 - 152mm Zinc Plated

### MEDIUM WEIGHT STEEL HASP & STAPLE



HO168001 - 102mm Japanned  
HO168002 - 127mm Japanned  
HO168003 - 152mm Japanned

## Multipoint Locks

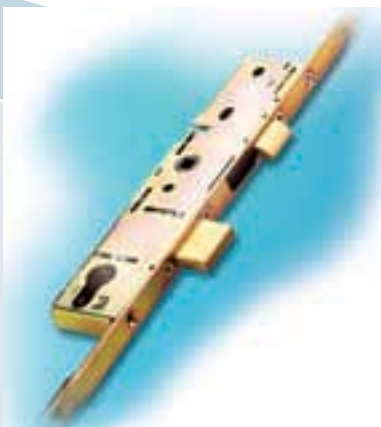

Multi point locks are available with either 3 or 5 point locking. They are operated by a Euro profile cylinder which are supplied separately.

HO192001 - TLP3 Standard Duty 3 Point Dead Bolt Lock

HO192010 - TLP5 Standard Duty 5 Point Dead Bolt Lock

HO192011 - TLP5 Heavy Duty 5 Point Dead Bolt Lock

For Cylinders To Operate These Locks Please See Pages 383 and 422

Digital Locks



CODELOCK MECHANICAL DIGITAL LOCK

Over 8000 Code Combinations  
Auto Deadlocking  
Reversible  
Light to Medium Traffic Duty

- H0201001 - SCP
- H0201002 - Brassed
- H0201011 - SCP with Hold Back
- H0201012 - Brassed with Hold Back

DEEDLOCK DKM210 DIGITAL DEADLOCKING DOOR LOCK

A self-contained battery powered digital door lock.  
Simple to use & easy to program.  
Automatic locking deadbolt  
Optional holdback  
Powered by four AA batteries with an early warning light for low battery  
Illuminated keypad  
Key override facility  
Optional remote control

- H0201061 - Silver



ZONE 2000 MECHANICAL DIGITAL LOCK

Zone 2100 Mechanical Digital Lock  
Over 8000 combinations  
Auto deadlocking  
Reversible  
Light to medium traffic duty

- H0201071 - SCP
- H0201072 - Brass
- H0201081 - SCP with Holdback
- H0201082 - Brass with Holdback

Digital Locks



**UNICAN L1000-1 MECHANICAL  
DIGITAL LOCK**

Lever handle operation  
Single code up to 5 digits or combination of digits  
Auto deadlocking  
Internal and external use  
Suitable for doors 35mm to 57mm thick  
High traffic duty

H0201051 - SCP L/H  
H0201052 - SCP R/H



**SIMPLEX NL200**

Single code up to 5 digits or combination of digits  
Auto deadlocking  
Internal and external use  
Medium traffic duty

H0201501 - SCP  
H0201502 - Satin Brassed



**UNICAN 7004. MECHANICAL  
DIGITAL DOOR LOCK**

Knob handle operation.  
Single Code up to 5 Digits or Combination of Digits  
Auto deadlocking  
Internal and external use  
Suitable for doors 35mm to 57mm thick  
Medium traffic duty

H0201041 - SC  
H0201042 - PB



**UNICAN 1000-1 MECHANICAL  
DIGITAL LOCK**

Knob handle operation  
Single code up to 5 digits or combination of digits  
Auto deadlocking  
Internal and external use  
Suitable for doors 35mm to 57mm thick  
High traffic duty

H0201511 - SC

Security Fittings



Key in Knob Set

BEVERLEY DUMMY KNOB



HO199601 - Polished Brass  
HO199602 - SCP

BEVERLEY LATCH SET



Backset Adjustable 60 or 70mm  
HO199611 - Polished Brass  
HO199612 - SCP

BEVERLEY  
BEDROOM/BATHROOM SET



Backset Adjustable 60 or 70mm  
HO199621 - Polished Brass  
HO199622 - SCP

BEVERLEY LOCK SET

Key outside, turn button inside



Backset Adjustable 60 or 70mm  
HO199631 - Polished Brass  
HO199632 - SCP

BEVERLEY  
STOREROOM LOCK SET

Keyed outside only,



Backset Adjustable 60 or 70mm  
HO199641 Polished Brass  
HO199642 - SCP

TROY DUMMY KNOB



HO199701 - Polished Brass

TROY LATCH SET



Backset Adjustable 60 or 70mm  
HO199702 - Polished Brass

TROY BEDROOM/BATHROOM  
SET



Backset Adjustable 60 or 70mm  
HO199703 - Polished Brass

TROY LOCK SET

Key outside, turn button inside



Backset Adjustable 60 or 70mm  
HO199704 - Polished Brass

DOUBLE CYLINDER  
DEAD BOLT



Backset Adjustable 60 or 70mm  
HO199801 - Polished Brass  
HO199802 - SCP

SINGLE CYLINDER  
DEAD BOLT

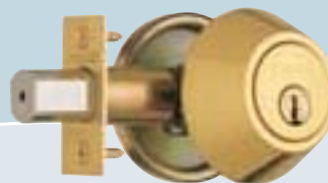

Backset Adjustable 60 or 70mm  
HO199811 Polished Brass  
HO199812 - SCP

SPRING LATCH



Backset 127mm  
HO199901 - Brass  
HO199902 - SCP

DEADLOCKING LATCH

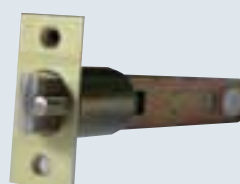

Backset 127mm  
HO199911 - Brass  
HO199912 - SCP

**Fire Brigade Locks**

**FB1  
GLC 45 RIM DEAD LOCKS**

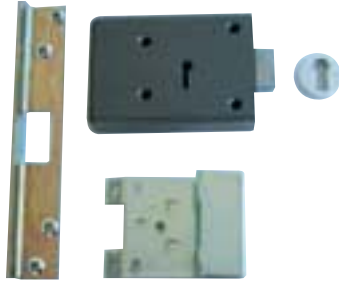

Keys Not included

- H0140001 - L/H OPENING OUT
- H0140002 - L/H OPENING IN
- H0140011 - R/H OPENING OUT
- H0140012 - R/H OPENING IN

**FB2  
GLC 46 RIM DEAD LOCKS**

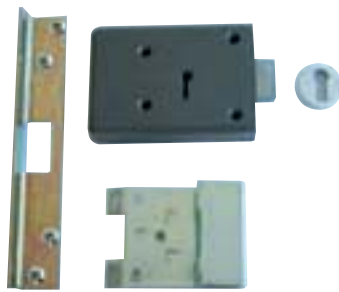

Keys Not included

- H0140501 - L/H OPENING OUT
- H0140502 - L/H OPENING IN
- H0140511 - R/H OPENING OUT
- H0140512 - R/H OPENING IN

**FB4  
GLC RIM SLAMLOCK**



Keys Not included

- H0141001 - L/H OPENING IN
- H0141002 - R/H OPENING OUT
- H0141011 - L/H OPENING OUT
- H0141012 - R/H OPENING OUT

**HANDING OF LOCKS**

To determine the hand you require view door from the side the lock is to be fitted.  
If the door is hinged on the right you require a R/H lock  
If the door is hinged on the left you require a L/H lock.

**GLC 45A FB1  
MORTICE DEAD LOCK**



Keys Not included

- H0141501 -

**GLC 46A FB2  
MORTICE DEAD LOCK**

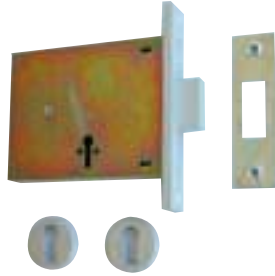

Keys Not included

- H0141511 -

**FB KEYS ONLY**



- H0142501 - FB1
- H0142502 - FB2
- H0142504 - FB4

Rebate sets to suit 45A & 46A deadlocks

- H0141521- 13mm
- H0141531- 25mm

**GLC 47 2 LEVER PADLOCK**



Keys Not included

- H0143001 - 51mm Galvanised
- H0143011 - 51mm With Chain
- H0143021 - No47 Keys

**GLC 14 4 LEVER PADLOCK**



Keys Not included

- H0143002 - 64mm Yellow
- H0143031 - No14 Keys

**GLC 11 4 LEVER PADLOCK**



Keys Not included

- H0143003 - 64mm Galvanised
- H0143041 - No11 Keys

Security Fittings

Intercom Systems



**NIMA COM**

Phone Intercom System with Electric Lock Release Button  
Plug in Transformer 230VAC/12VDC

- H0205001 - Black
- H0205002 - White



**NIMA PRO**

Phone Intercom System with Electric Lock Release Button  
Plug in Transformer 230VAC/12VDC

- H0205005 - Stainless Steel
- H0205006 - Gold



**NIMA STYLE**

Phone Intercom System with Electric Lock Release Button  
Plug in Transformer 230VAC/12VDC

- H0205009 - Stainless Steel on Oak
- H0205010 - Gold on Oak



**NIMA INTERPHONE**

System enables you to speak to callers via your own telephone. Can be connected to up to 8 telephones including cordless or dect phones.

- H0205014



**NIMA LATCH**

Wireless remote controlled door release system. Kit includes electric strike and two key fob controllers.

- H0205013

## Access Systems

### ANSWER MAID CCTV INTERCOM SYSTEM



Intercom system linked to your normal television screen enabling you to both see and hear people calling at your door.

H0205015

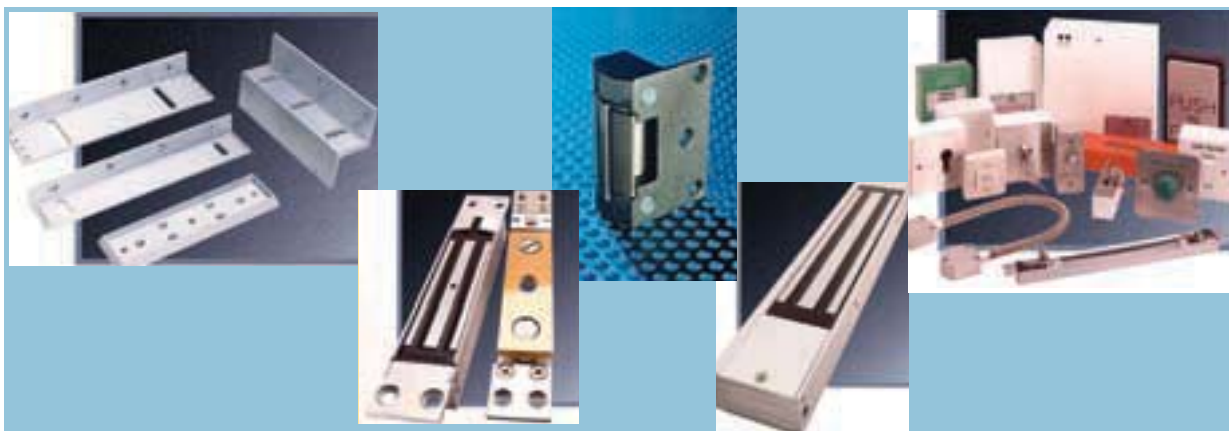

#### MAGNETIC LOCKS

- H2900300 - 250kg Holding
- H2900301 - 250kg Holding Monitored
- H2900302 - 500kg Holding
- H2900303 - 500kg Holding Monitored

#### 800 SERIES SHEARLOCK

H2900350

#### ELECTRONIC KEYPAD

H2900355 - DAC6265

#### BUDGET ELECTRIC STRIKES 12V DC RIM/MORTICE

- H2900310 - DR230 Fail Safe
- H2900311 - DER221 Fail Secure

#### MOUNTING BRACKETS FOR MAGNETIC LOCKS

- H2900320 - DMH463-L Bracket for 250kg
- H2900321 - DMH463-ZZ&L Bracket for 250kg
- H2900322 - DMH465-LL Bracket for 500kg
- H2900323 - DMH465-ZZ&L Bracket for 500kg
- H2900324 - DMH463-R Glass Door Mounting 250kg
- H2900325 - DMH465-R Glass Door Mounting 500kg

#### SWITCHES

- H2900340 - Key Switch Stainless Steel
- H2900341 - Surface Housing for key Switch
- H2900342 - Heavy Duty Green Dome Push Button
- H2900343 - Touch Sensitive Button & Surface Box

#### TRIMEC ELECTRIC STRIKES

- H2900312 - ES110 12V DC
- H2900313 - ES150 12V DC

Easily changed to either fail safe or fail secure.

#### POWER SUPPLIES

- H2900330 - DPS100 12V DC 1 Amp Power Supply
- H2900331 - DPS200 12V 2 Amp Power Supply
- H2900332 - DPB226 12V DC Interface Relay
- H2900334 - DPB225 24V DC Fire Relay
- H2900335 - DLP101 Concealed Door Loop

#### CONTROL SOFT STARTER KITS

H2900360 - DAC321

Access Systems

**Hinges**

**1838 STEEL BUTT HINGE  
MEDIUM WEIGHT BRIGHT  
STEEL**



- H0440001 - 40mm
- H0440011 - 50mm
- H0440021 - 60mm
- H0440031 - 75mm
- H0440041 - 100mm

**1838 STEEL BUTT HINGE  
MEDIUM WEIGHT ZINC  
PLATED**



- H0440501 - 75mm
- H0440511 - 100mm

**451 STRONG SINGLE FLAP  
HINGES BRIGHT STEEL**



- H0441001 - 75mm
- H0441011 - 100mm

**899 EXTRA STRONG  
HINGE DOUBLE PRESSED  
BRIGHT STEEL**



- H0441501 - 75mm
- H0441511 - 100mm
- H0441521 - 150mm

**No 200 CAST IRON BUTT  
HINGE SELF COLOUR**



- H0442001 - 75mm
- H0442011 - 100mm

**STAINLESS STEEL BUTT  
HINGE**



- H0442501 - 75 x 50mm
- H0442511 - 100 x 75mm

**STEEL BROAD BUTT HINGES  
BRIGHT STEEL**



- H0444021 - 75 x 75mm
- H0444031 - 100 x 100mm

**STRONG STEEL WASHERED  
BUTT HINGES**

With Delrin washers Silver Enamelled

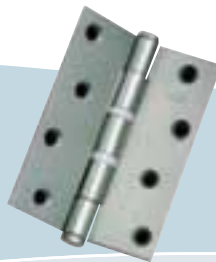

- H0445011 - 100 x 75mm

**STEEL PARLIAMENT HINGES  
BRIGHT STEEL**

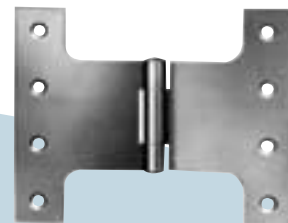

- H0450501 - 75mm
- H0450511 - 100mm

**STEEL RISING BUTT HINGE  
BRIGHT STEEL**



- H0451001 - 75mm R/H (Illustrated)
- H0451002 - 75mm L/H
- H0451011 - 100mm R/H
- H0451012 - 100mm L/H

**STEEL RISING BUTT HINGES  
ZINC PLATED**



- H0451021 - 100 x 75mm R/H (Illustrated)
- H0451022 - 100 x 75mm L/H

**ALUMINIUM RISING BUTT  
HINGES SAA**



- H0451041 - 100 x 65mm R/H (Illustrated)
- H0451042 - 100 x 65mm L/H



**Hinges**

**GRAVITY HINGE ADJUSTABLE  
TO HOLD OPEN OR CLOSED**



H0444801 - TP10 L/H  
H0444811 - TP11 R/H

**ALUMINIUM FALLING  
BUTT HINGE SAA**



H0451501 - 75 x 65  
R/H (Illustrated)  
H0451502 - 75 x 65 L/H  
H0451511 - 100 x 65 R/H  
H0451512 - 100 x 65 L/H

**STEEL BACKFLAP HINGE  
BRIGHT STEEL**



H0452001 - 25 x 75mm  
H0452011 - 32 x 80mm  
H0452021 - 38 x 90mm  
H0452031 - 50 x 105mm  
H0452041 - 65 x 150mm

**STORMPROOF CASEMENT  
HINGE ZINC PLATED STEEL**

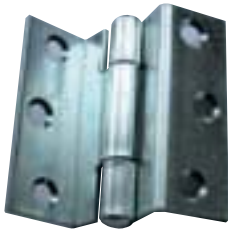

H0455501 - 65mm

**EASYSOFT WINDOW  
HINGES SHERADISED**



H0452101 - 100mm leg  
16mm Projection

**TRESTLE JOINTS  
MALLEABLE IRON**



H0466001 - 305mm Japanned

**SOLID DRAWN BRASS  
BUTT HINGE**



H0443021 - 65mm Sanded Brass

**SOLID DRAWN BRASS BUTT  
HINGE DOUBLE STEEL  
WASHERS AND PINS**



H0445501 - 75 x 50mm  
H0445511 - 100x 65mm  
H0445521 - 100 x 75mm  
H0445531 - 125 x 75mm

**SOLID DRAWN BRASS BUTT  
HINGE DOUBLE STEEL  
WASHERS,  
BRASS PINS.**



H0445551 - 75 x 50mm  
H0445561 - 100x 65mm  
H0445571 - 100 x 75mm  
H0445581 - 125 x 75mm

**BRASS PARLIAMENT  
HINGE SANDED**

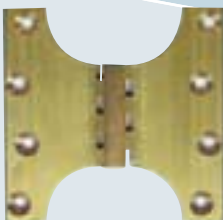

H0450551 - 100 x 65 x 100mm

**BRASS RISING BUTT HINGE  
SANDED BRASS**



H0451061 - 100 x 65mm R/H  
H0451062 - 100 x 65mm  
L/H (Illustrated)

**BRASS COUNTER FLAP HINGE  
SANDED BRASS**



H0453501 - 75 x 25mm  
H0453511 - 100 x 32mm  
H0453521 - 115 x 38mm

Hinges

**Hinges**

**COUNTER FLAP CATCH  
POLISHED BRASS**



H0454001 - 35 x 22mm

**PIANO HINGE 1800MM  
0.66MM THICKNESS**



Electro Brassed

H0452501 - 25mm Open  
H0452503 - 30mm Open  
H0452505 - 38mm Open

Nickel Plated

H0452502 - 25mm Open  
H0452504 - 30mm Open  
H0452506 - 38mm Open

**SOSS CONCEALED HINGES  
SOLID BRASS SELF COLOUR**



Door Thickness 19mm  
H0453001 - 44 x 13mm No 203

Door Thickness 25mm  
H0453011 - 70 x 16mm No 208

Door Thickness 35mm  
H0453021 - 117 x 25mm No 216

Door Thickness 44mm  
H0453031 - 117 x 28mm No 218

Door Thickness 50mm  
H0453041 - 140 x 35mm No 220

**CONTINUOUS HINGE  
HEAVY DUTY**



Self  
Colour

Stainless Steel 2.5mm Thickness 7mm Pin Diameter

H0452507 75mm(Open) x 2mtr  
H0452508 100mm(Open) x 2.134mtr

Hinges

**Royde & Tucker**

**H101 HI-LOAD LIFT OFF  
HINGE 100 X 85MM**



H0444701 - BZP L/H (Illustrated)  
H0444721 - BZP R/H

**H102 HI-LOAD BUTT  
HINGE 100 X 88MM**



H0444601 - BZP  
H0444602 - SNP  
H0444603 - Simulated S/Steel  
H0444605 - Simulated P.B

**H103 HI-LOAD BUTT  
HINGE 100 X 86MM**



H0444901 - BZP

Available in other finishes including colours to match Normbau & Hewi

**Royde & Tucker**

**H104 HI-LOAD BUTT HINGE 100 X 75MM**



H0444902 - BZP

**H105 HI-LOAD LIFT OFF HINGE 98 X 84MM**



H0444903 - BZP

**H107 HI-LOAD LIFT OFF HINGE 110 X 98MM**



H0444904 - BZP

**H207 CONCEALED BEARING TEMPLATE HINGES 101.6 X 76.2MM**



H0444905 - SSS

**H208 CONCEALED BEARING TEMPLATE HINGES 101.6 X 88.9MM**



H0444906 - SSS

**H209 CONCEALED BEARING TEMPLATE HINGE 101.6 X 101.6MM**



H0444907 - SSS

**Steel Hinges**

**STEEL TEE HINGES MEDIUM WEIGHT**



H0460001 - 230mm Japanned  
H0460011 - 300mm Japanned  
H0460021 - 375mm Japanned  
H0460031 - 450mm Japanned

**STEEL TEE HINGES HEAVY WEIGHT**



H0460501 - 600mm Self Colour

**STEEL TEE HINGES HEAVY WEIGHT**



H0460551 - 300mm Galvanised  
H0460561 - 450mm Galvanised  
H0460571 - 600mm Galvanised

**STEEL STRAP HINGES**



H0461001 - 152mm Bright Steel  
H0461011 - 203mm Bright Steel  
H0461021 - 305mm Bright Steel  
(Closed Sizes Shown)

**STEEL REVERSIBLE HINGES LIGHT PATTERN**



H0461501 - 254mm Self Colour  
H0461511 - 305mm Self Colour  
H0461521 - 406mm Self Colour  
H0461531 - 457mm Self Colour  
H0461541 - 610mm Self Colour

**STEEL REVERSIBLE HINGES HEAVY PATTERN**



H0462001 - 457mm Self Colour  
H0462011 - 610mm Self Colour  
H0462021 - 760mm Self Colour  
H0462031 - 914mm Self Colour

Hinges

**Hinges**

**WROUGHT IRON HOOK & RIDE HINGES  
SELF COLOUR**



- H0463001 - 305mm
- H0463011 - 405mm
- H0463021 - 457mm
- H0463031 - 610mm
- H0463041 - 760mm
- H0463051 - 915mm

**WROUGHT IRON CELLAR  
FLAP HINGE**



H0463501 - 457mm

**COLLINGS GATE HINGES  
HEAVY CAST IRON**



**Right Hand**

- H0464001 - 457mm
- H0464011 - 610mm
- H0464021 - 760mm
- H0464031 - 914mm
- H0464041 - 1065mm
- H0464051 - 1220mm

**Left Hand (Illustrated)**

- H0464002 - 457mm
- H0464012 - 610mm
- H0464022 - 760mm
- H0464032 - 914mm
- H0464042 - 1065mm
- H0464052 - 1220mm

**COLLINGS HINGE  
CUPS FOR WOOD**



**To Suit Hinge Size**

- H0464501 - 457mm & 610mm
- H0464511 - 760mm
- H0464521 - 914mm & 1065mm
- H0464531 - 1220mm

**COLLINGS HINGE  
CUPS FOR STONE**



**To Suit Hinge Size**

- H0464502 - 457mm & 610mm
- H0464512 - 760mm
- H0464522 - 914mm & 1065mm
- H0464532 - 1220mm

**Hinges**

**DOUBLE STRAP FIELD GATE HINGES**

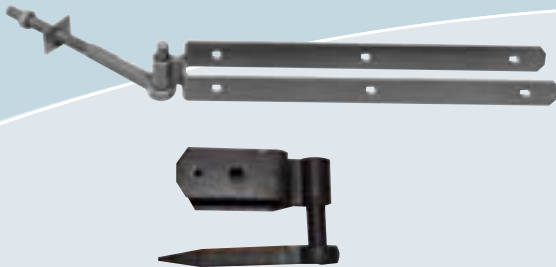

Comprising one long band with hook to bolt and one short band with hook to drive. To suit 75mm thick gates.

H0465001 - 610mm Self Colour

**FIELD GATE LATCH**

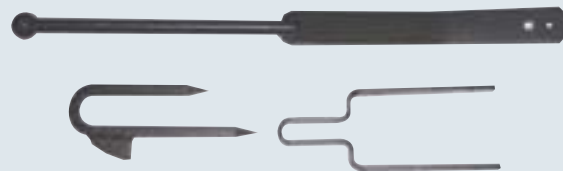

H0465501 - 610mm Self Colour

## Garage Door & Gate Fittings

### HEAVY DUTY GATE WHEEL



H0465511 - 368mm Epoxy Black

### COIL GATE SPRINGS

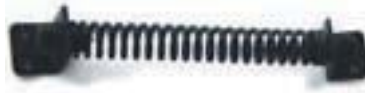

H0436051 - 203mm Black Japanned  
H0436061 - 255mm Black Japanned

### PLAIN GATE STOP



Z4021551 - 102 x 76mm  
Z4021552 - 127 x 102mm  
Z4021553 - 152 x 127mm

### SELF ACTING GATE STOP WITH PICKUPS



Z4021561 - 102 x 102mm  
Z4021562 - 190 x 165mm  
Z4021563 - 241 x 184mm

### BALANCE GATE CATCH WITH LUGS FOR STONE



H0498001 - 305mm

### GATE LATCH WITH RING HANDLES



H0786001 - 178mm Black Mall Iron  
H0786002 - 178mm Galvanised

### SUFFOLK LATCH MEDIUM WEIGHT No 2



H0786501 - 191mm Japanned

### SUFFOLK LATCH HEAVY WEIGHT No 3



H0786521 - 229mm Japanned  
H0786522 - 229mm Galvanised

### AUTOMATIC GATE CATCH MEDIUM PATTERN



H0787501 - 51 x 51mm Galvanised

### AUTOMATIC GATE CATCH HEAVY PATTERN



H0787511 - 60 x 57mm Galvanised

### CRUMPTON GARAGE DOOR HOLDER WITH CORD RELEASE



Pair For Wide Lintels  
H0497501 - 610mm Japanned  
Pair For Narrow Lintels  
H0497511 - 610mm Japanned  
Single Light Pattern For Narrow Lintels  
H0497521 - 405mm Japanned

### GARAGE DOOR, DROP BOLT



H0495001 - 305 x 16mm  
H0495011 - 455 x 16mm  
H0495021 - 610 x 16mm



## Garage Door & Gate Fittings

### GARAGE DOOR CHAIN BOLT



H0496501 - 200mm Japanned  
H0496502 - 200mm Zinc Plated

### FOOT ACTIVATED GARAGE DOOR BOLT

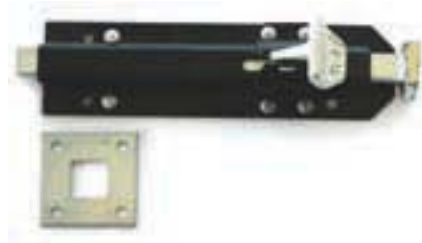

H0497001 - 175 x 50mm Japanned  
H0497002 - 175 x 50mm Electric Galvanised

### MONKEY TAIL BOLT WITH STAPLE



H0494501 - 380 x 16mm  
H0494511 - 455 x 16mm  
H0494521 - 610 x 16mm  
H0494531 - 760 x 16mm  
H0494541 - 915 x 16mm  
H0494551 - 1220 x 16mm

### SQUARE SPRING BOLT

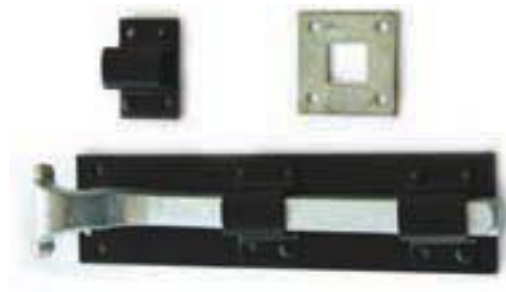

H0493001 - 200 x 16mm  
H0493011 - 255 x 16mm

### SQUARE BOLT SOCKET



H0493501 - 16mm

### TUBULAR BOLT SOCKET



H0494011 - 16mm

## Henderson Garage Doors

As there is an enormous range of garage doors available to choose from, we show here a small selection of the types available to order. Whether you require a wooden, GRP or steel door with or without remote control we can meet your requirements. Please ask for a brochure detailing the full range available to you.

### TIMBER



### METAL



### GRP



## Gates

We supply a range of metal gates ready primed for painting on site. Available in a wide range of sizes and styles, we show here a small selection of patterns we can offer in both single and double gates either from stock or to special order.

### ESSEX SINGLE GATES

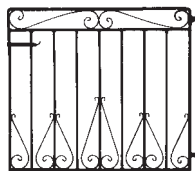

Height 3' Opening 3'

- Z4020501 - R/H Wood Fixing
- Z4020505 - R/H Brick Fixing
- Z4020507 - L/H Wood Fixing
- Z4020509 - L/H Brick Fixing

### ESSEX DOUBLE GATES



Height 3' Opening 7'

- Z4020503
- Height 3' Opening 7'6"
- Z4020504

### SIDE ENTRANCE GATES



Available arch or square top to suit most patterns.

**Hanging**  
State whether hinges are required on L/H or R/H side with gate opening away from you.

Height 3' Opening 3'6"

- Z4020502 - R/H Wood Fixing
- Z4020506 - R/H Brick Fixing
- Z4020508 - L/H Wood Fixing
- Z4020510 - L/H Brick Fixing

### PATTERNS

available to order

Kent



Montano



Alde



Sussex

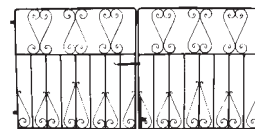

County



Talbot

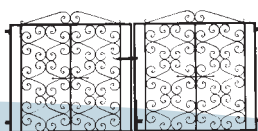

Adrian



Gipping



All patterns are available as single gates to suit 3' or 3'6" opening and pairs to suit 7' to 10' opening in 6" multiples. Special sizes can be manufactured to suit non standard openings. Wall panels can also be made to suit all gate designs, in either 18" or 24" heights, with lugs for brickwork or drilled for woodscrews.

### ROUND STEEL POSTS

For Single Gates

- Z4020551 - 50mm Diameter

For Double Gates

- Z4020552 - 50mm Diameter

### HEAVY DUTY GATE CLOSER GC.2000



This gate closer can be fitted to the top, middle or bottom of the gate on the pull side only.

#### Features

- Easy installation, compact and durable.
- Over 1000 operations.
- 90 degree hold open function.
- Two speed closing.
- Suitable for indoor or outdoor installation.
- Can be used on wooden doors or metal gates.

Z4020558

### HOLD BACK CATCHES

For Double Gates

- Z4020553 Per Pair

# Door Controls

## DOOR SPRING FOR MEDIUM DOORS ADJUSTABLE TENSION



H0434501 - Nickel Plated

## GIBRALTAR DOOR SPRING



H0432501 - White

## DICTATOR DOOR CHECK FOR DOORS FLUSH WITH FRAME



H0435001 - Galvanised

## HAWGOODS SPRING HINGE



To Suit 40 - 50mm Doors up to 930 wide & 60kg

H0433011 - Stainless/Zinc 255 x 16mm

## PERKO CONCEALED DOOR CLOSER

FULLY ADJUSTABLE SUITABLE FOR USE ON  
FIRECHECK DOORS



Barrel 140 x 22mm

Plates 51 x 25mm

H0430001 - Brass

## PERKOMATIC HYDRAULIC CONCEALED DOOR CLOSER



Barrel 168 x 60 x 23mm

Plates 96 x 25mm

H0431001 - Brass

Door Controls



## Door Controls

### BRITON 121 DOOR CLOSER



Power Size 3  
Body Size  
181W x 45H x 59D

H0412532 - Silver

### BRITON 210 DOOR CLOSER



Power Size 2 -4  
Body Size  
226W x 60H x 48D

H0411101 - Size 2-4 Silver

### BRITON 121 DOOR CLOSER WITH COVER

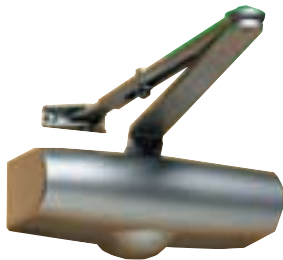

Power Size 3  
Body Size  
185W x 70H 67D

H0412601 - Silver

### BRITON 2000 SERIES WITH BACKCHECK SPEED CONTROL & LATCH ACTION

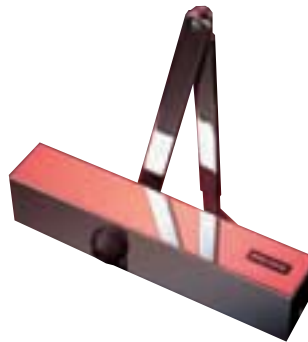

Adjustable Power  
Size 2- 6  
Body Size  
310W x 55H x 66D

H0413501 - 2515E Silver  
H0413503 - 2515E Polished Brass

### BRITON 2000 SERIES SPEED CONTROL & LATCH ACTION.

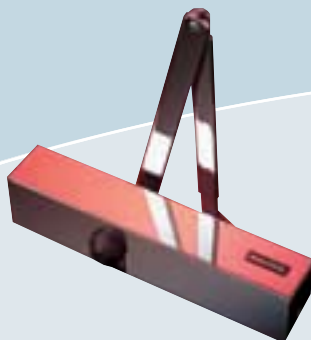

Fixed Strength  
Body Size  
249W x 48H x 59D

H0412001 - 2002E Silver Power Size 2  
H0412003 - 2002E PB Power Size 2  
H0412501 - 2003E Silver Power Size 3  
H0412503 - 2003E PB Power Size 3  
H0413001 - 2004E Silver Power Size 4  
H0413003 - 2004E PB Power Size 4

H0412511 - 2003ESO Silver  
C/W Stand Open Arm

### BRITON 2000 SERIES SPEED CONTROL, LATCH ACTION, BACKCHECK & DELAYED ACTION

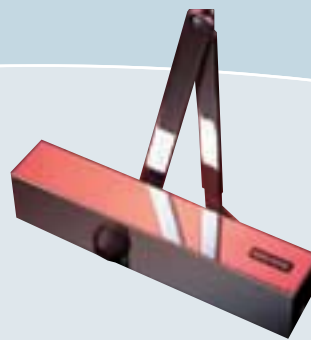

Adjustable Power  
Size 2 - 6  
Body Size  
310W x 55H x 66D

H0413601 - 2715E Silver  
H0413603 - 2715E Polished Brass



## Door Controls

### BRITON ACCUFIT 3000 SERIES WITH LC COVER



Cover Size 3100 & 3200  
258W x 59H x 62D  
Cover Size 3300 & 3400  
318W x 74H x 62D

LC3100 Power Size 2 - 4  
HO411601 Silver  
HO411602 PB  
HO411603 PSS  
HO411604 SSS

LC3200 Power Size 1 - 4 with Backcheck  
HO411611 Silver  
HO411612 PB  
HO411613 PSS  
HO411614 SSS

LC3300 Power Size 1 - 6 with Backcheck  
HO411641 Silver

LC3400 Power Size 1 - 6 with Backcheck & Adjustable  
Delayed Action  
HO411651 Silver

### BRITON ACCUFIT 3000 SERIES WITH SC COVER



Size 3100 & 3200  
258W x 71H x 65D  
Cover Size 3300 &  
3400  
318W x 76H x 71D

SC3100 Power Size 2 - 4  
HO411621 Silver  
HO411622 PB  
HO411623 PSS  
HO411624 SSS

SC3200 Power Size 1 - 4 with Backcheck  
HO411631 Silver  
HO411632 PB  
HO411633 PSS  
HO411634 SSS

SC3300 Power Size 1 - 6 with Backcheck  
HO411661 Silver

SC3400 Power Size 1 - 6 with Backcheck & Adjustable  
Delayed Action  
HO411671 Silver

### BRITON 2000 SERIES SLIDE ARM CLOSERS



Body Size 2003TE  
249W x 48H x 59D

Body Size 2514TE  
310W x 55H x 66D

HO413701 2003TE Silver  
Fixed Strength Power Size 3  
HO413801 2514TE Silver  
Adjustable Strength Size 1 - 4  
with Backcheck

### BRITON ACCUFIT 3000 SERIES SLIDE ARM CLOSERS WITH BACKCHECK



Body Size 3200  
LC cover 258W x 59H x 62D  
SC Cover 258W x 71H x 65D  
Body Size 3300  
LC Cover 318W x 74H x 62D  
SC Cover 318W x 76H x 71D

HO411701 LC3200T Silver  
Fixed Strength Power Size 3  
HO411711 LC3300T Silver  
Adjustable Strength Power Size 1 - 4  
HO411721 SC3200t Silver  
Fixed Strength Power Size 3  
HO411731 SC3300t Silver  
Adjustable Strength Power Size 1 - 4

# Door Controls

## Door Controls

### DORMA TS68 SPEED CONTROL AND LATCH ACTION



Adjustable Power  
EN 2/3/4

Body Size  
220W x 53.5H x 45D

H0421501 - Silver

### DORMA TS73V DOOR CLOSER BACKCHECK, SPEED CONTROL AND LATCH ACTION

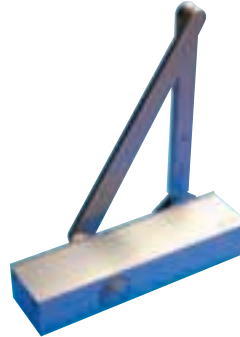

Variable Power  
EN 2-4

Body Size  
233W x 42.5H x 60D

H0421701 - Silver

### DORMA TS71 SPEED CONTROL AND LATCH ACTION



Adjustable Power  
EN 3/4

Body Size  
232W x 68H x 45D

Available to Match Normbau and Hewi Colours

H0421001 - Silver

### DORMA TS73NDC DOOR CLOSER DELAYED ACTION, SPEED CONTROL AND LATCH ACTION



Adjustable Power  
EN 3/4

Body Size  
208W x 42.5H x 60D

H0421401 - Silver

### DORMA TS72VBC ADJUSTABLE BACKCHECK SPEED CONTROL LATCH ACTION



Variable Power  
EN 2-4

Body Size  
232W x 68H x 45D

H0421601 - Silver

### DORMA TS83 DOOR CLOSER BACKCHECK, DELAYED ACTION, SPEED CONTROL AND LATCH ACTION



Variable Power  
EN 2-6

Body Size  
293W x 47.5H x 60D

Available to Match Normbau and Hewi Colours

H0422001 - Silver

**Door Controls**

**DORMA TS91**  
CAM ACTION, SPEED CONTROL  
& LATCH ACTION

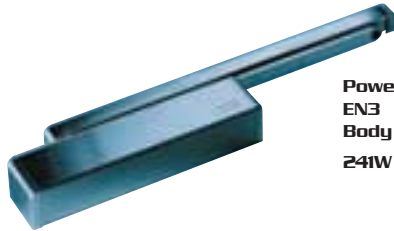

Power Size  
EN3  
Body Size  
241W x 64.5 H x 51.5D

**H0421901 Silver**  
For Pull Side Applications Only

**DORMA TS92**  
CAM ACTION, SPEED CONTROL  
& LATCH ACTION

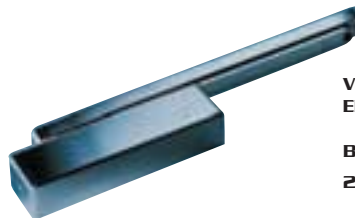

Variable Power  
EN 2-4  
  
Body Size  
240W x 60H x 51D

Available to Match Normbau and Hewi Colours

**H0421801 - TS92 Body Only Silver**  
**H0421802 - G92N Arms and Channel**

**DORMA TS93**  
CAM ACTION, BACKCHECK, DELAYED  
ACTION, SPEED CONTROL &  
LATCH ACTION

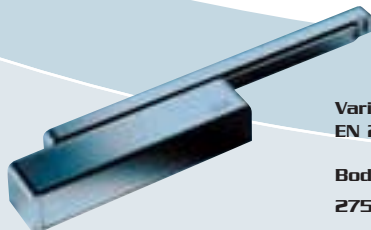

Variable Power  
EN 2-5  
  
Body Size  
275W x 60H x 53D

**H0422501 - TS93 Body Only Silver**  
For Pull Side Application  
**H0422601 - G93N Arm & Channel**  
**H0422602 - G93N Angle Bracket**  
For Push Side Application

**DORMA RTS85 CONCEALED**  
TRANSOM MOUNTED FIXED POWER



Body Size  
328.5W x 94H x 38.5D

**RTS85 Bodies Only**

- H0423001 - Standard Power Size EN 3**
- H0423002 - 90° Hold Open Power Size EN 4**
- H0423003 - 105° Hold Open Power Size EN 5**
- H0423011 - Standard Power Size EN4**
- H0423012 - 90° Hold Open Power size EN4**
- H0423013 - 105° Hold Open Power Size EN4**
- H0423021 - Standard Power Size EN5**
- H0423022 - 90° Hold Open Power Size EN5**
- H0423023 - 105° Hold Open Power Size EN5**

**RTS85 Accessories**

- H0423031 - 8530 Side Load Arm & Channel**
- H0423032 - 8534 End Load Arm & Channel**
- H0423041 - 8550/1 Side Load Universal Floor Pivot**
- H0423042 - 8552/3 End Load Universal Floor Pivot**
- H0423051 - RTS85W Silver Cover Plate for Wood**
- H0423052 - RTS85M Silver Cover Plate for Metal**

**DORMA ITS96 CONCEALED**  
CAM ACTION, SPEED CONTROL,  
LATCH ACTION & CUSHIONED LIMIT STAY



Variable Power  
2-4  
  
Body Size  
277W x 45H x 32D

**H0422701 - ITS96 Body Only**  
**H0422702 - G96N Arm & Channel**

Door Controls

**Door Controls**

**LCN 4010/4110 SERIES**



Variable Power Size 3 - 5

Body Size  
311W x 89H x 57D

- H0411701 - 4111 Silver Push Side Application
- H0411702 - 4011 Silver Pull Side Application

**LCN 4040 SERIES**



Variable Power Size 3 - 5

Body Size  
311W x 89H x 57D

- H0411703 - 4041 silver Universal Fitting

**LCN 3130 SERIES CONCEALED**



- H0411801 - 3133 Silver Power Size 3 R/H
- H0411802 - 3133 Silver Power Size 3 L/H

**OVERHEAD DOOR STAY  
356 x 29MM**



- H0431501 - Electro Galvanised

**CLOSE RITE DOOR SELECTOR**



- H0432001 - Brass
- H0432002 - Silver

**DOOR SELECTOR**



- H0433601 - SAA

**Floor Springs**

**DORMA BT575V**  
**UNIVERSAL WITH BACKCHECK**  
**NO HOLD OPEN**



Variable Power  
 EN 1 - 4  
 Box Size  
 285L x 82Wx 50H  
 Maximum Door Sizes  
 Width 1200mm Weight  
 120kg

H0425002

**DORMA BT580**  
**WITH BACKCHECK, DELAYED ACTION & HOLD**  
**OPEN DEVICE WHICH CAN BE TURNED OFF**



Box Size  
 341l x 78w x 60h  
 Maximum Door Sizes  
 EN 4 Width 1200mm Weight  
 300kg

H0426002 - Power Size EN 4

**BT575V ACCESSORY PACKS**



- H0425003 - Stainless Steel Single Action
- H0425004 - Satin Brass Single Action
- H0425005 - Stainless Steel Double Action
- H0425006 - Satin Brass Double Action

**BT580 ACCESSORY PACK**

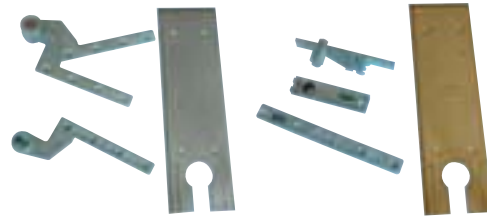

- H0426003 - Stainless Steel Single Action
- H0426004 - Satin Brass Single Action
- H0426005 - Stainless Steel Double Action
- H0426006 - Satin Brass Double Action

All accessory packs include top centre, bottom strap, cover plate, fixing screws and instructions.

**Pivot Sets**

**H131-100 DOOR PIVOT SET**

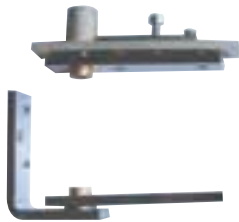

To suit doors up to 80kg

H0434081 - Satin Stainless Steel

**H131-105 EMERGENCY DOOR STOP**



H0434091 - Satin Stainless Steel

**WELLINGTON DOOR PIVOT SET**



To suit doors up to 30kg

H0434061 - SAA

**WELLINGTON EMERGENCY DOOR STOP**



H0434071 - ZP

Floor Springs



**Bolts**

**SAA STRAIGHT  
BARREL BOLT**



- H0480001 - 50 x 25mm
- H0480011 - 75 x 25mm
- H0480021 - 100 x 25mm
- H0480031 - 150 x 25mm
- H0480041 - 150 x 32mm
- H0480051 - 200 x 32mm

**POLISHED BRASS STRAIGHT  
BARREL BOLT**



- H0480501 - 50 x 25mm
- H0480511 - 75 x 25mm
- H0480521 - 100 x 25mm
- H0480531 - 150 x 25mm
- H0480541 - 150 x 32mm
- H0480551 - 200 x 32mm
- H0480561 - 255 x 38mm
- H0480571 - 300 x 38mm

**CHROME PLATED STRAIGHT  
BARREL BOLT**



- H0481501 - 75 x 25mm
- H0481511 - 100 x 25mm
- H0481521 - 150 x 25mm
- H0481531 - 150 x 32mm
- H0481541 - 200 x 32mm
- H0481551 - 255x38mm
- H0481561 - 300 x38mm

**SAA NECKED  
BARREL BOLT**



- H0482001 - 75 x 25mm
- H0482011 - 100 x 25mm
- H0482021 - 150 x 25mm

**POLISHED BRASS NECKED  
BARREL BOLT**



- H0482501 - 75 x 25mm
- H0482511 - 100 x 25mm
- H0482521 - 150 x 25mm

**CHROME PLATED NECKED  
BARREL BOLT**



- H0483501 - 75 x 25mm
- H0483511 - 100 x 25mm
- H0483521 - 150 x 25mm

**FLAT BOLT PLATES**



- H0484501 - 10mm Dipped Brass
- H0484511 - 13mm Dipped Brass

**ANGLE BOLT PLATES**

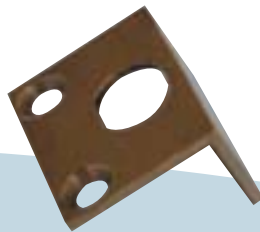

- H0484551 - 10mm Dipped Brass
- H0484561 - 13mm Dipped Brass

**BOAT SHAPE BOLT SOCKET FOR  
WOODEN FLOORS**



- H0485011 - 13mm S.C.P

**BOAT SHAPE BOLT SOCKET  
FOR STONE FLOORS**



- H0485061 - 13mm S.C.P

**DUST EXCLUDING  
SPRING BOLT SOCKET FOR  
WOODEN FLOORS**



- H0485501 - 10mm S.C.P
- H0485511 - 13mm S.C.P

**DUST EXCLUDING  
SPRING BOLT SOCKET FOR  
STONE FLOORS**



- H0485551 - 10mm S.C.P
- H0485561 - 13mm S.C.P

**Bolts**

**SAA SLIDING  
FLUSH BOLTS**



H0486001 - 100 x 15mm SAA  
H0486011 - 150 x 15mm SAA

**BRASS SLIDING  
FLUSH BOLTS**



H0486501 - 100 x 15mm Brass  
H0486511 - 150 x 15mm Brass  
H0486521 - 229 x 25mm Brass

**KNOB SLIDE  
FLUSH BOLT**



H0487501 - 229 x 25mm SCP

**SAA LEVER ACTION  
FLUSH BOLT**



H0488001 - 150 x 25mm SAA  
H0488011 - 200 x 25mm SAA  
H0488021 - 305 x 25mm SAA

**BRASS LEVER ACTION  
FLUSH BOLT**



H0488501 - 200 x 25mm Brass  
H0488511 - 305 x 25mm Brass

**CITADEL DOOR BOLT  
SANDED BRASS**



H0490002 - 35 x 25mm  
Sanded Brass

Flush Bolts

**Barrel Bolts**

**STRAIGHT TOWER BOLT  
JAPANNED PLATES BRIGHT  
SHOOTS**



- H0491001 - 100mm
- H0491011 - 150mm
- H0491021 - 200mm
- H0491031 - 255mm
- H0491041 - 305mm

**STRAIGHT TOWER BOLT  
GALVANISED**



- H0491012 - 150mm
- H0491022 - 200mm
- H0491042 - 305mm

**NECKED TOWER BOLT  
JAPANNED PLATES BRIGHT  
SHOOTS**



- H0491501 - 150mm
- H0491511 - 200mm

**STRONG BARREL BOLT  
JAPANNED PLATES BRIGHT  
SHOOTS**



- H0492501 - 150mm
- H0492511 - 200mm
- H0492521 - 255mm
- H0492531 - 300mm

**BRENTON  
PADLOCK BOLT  
GALVANISED**

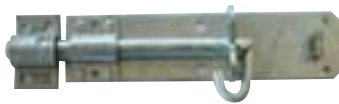

- H0495501 - 200 x 16mm
- H0495511 - 255 x 16mm
- H0495521 - 305 x 16mm

**OVAL PADLOCK BOLT  
GALVANISED**

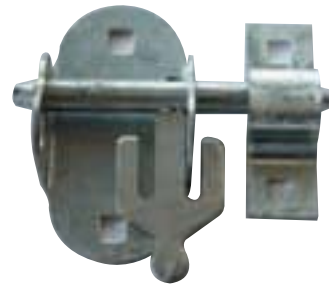

- H0496001 - 115mm

Barrel Bolts

**SQUARE BOLT SOCKET**



**TUBULAR BOLT SOCKET**



- H0493501 16mm Electro Galvanised
- H0494011 - 16mm Japanned

## Indicator Bolts

### UNION 8094 INDICATOR BOLT



Front 64 x 38mm  
Bolt 62 x 41mm

H0572501 - Electro Brass  
H0572502 - Chrome Plated  
H0572503 - Satin Chrome Plated

### IR2459 INDICATOR BOLT



Front 66 x 29mm  
Bolt 66 x 29mm

H0573001 - SAA

### INDICATOR BOLT

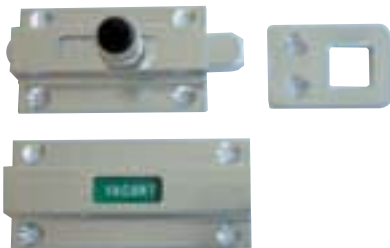

Front 67 x 32mm  
Bolt 54 x 31mm

H0573501 - SAA

### IR2485 MORTICE INDICATOR BOLT

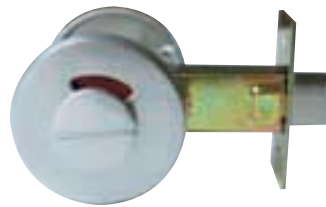

Mortice 82 x 38mm  
Front 53mm Diameter

H0574001 - SAA

### FACILITY INDICATOR BOLT FOR SLIDING AND HINGED DOORS



H0575501 - R/H SAA  
H0575502 - L/H SAA (Illustrated)  
H0575511 - R/H Gold  
H0575512 - L/H Gold (Illustrated)

To hand view door from the inside if door is hinged on the left you require a L/H if it is hinged on the right you require a R/H

### INDICATOR BOLT

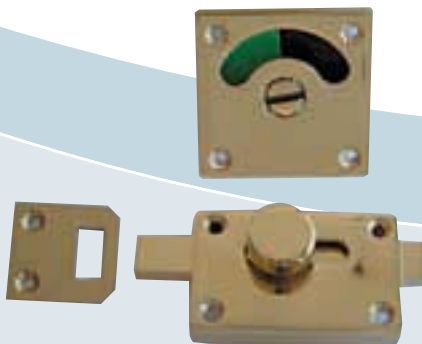

Front 56 x 56mm  
Bolt 76 x 44mm

H0574501 - SAA  
H0574502 - PB

### IR7427 INDICATOR BOLT FOR SLIDING & HINGED DOORS



79 x 41mm

H0575001 - SAA

# Indicator Bolts

**Fire Door Hardware**

**BRITON 376E**  
SINGLE PANIC BOLT



H0403001 - Silver

**BRITON 378E**  
SINGLE REVERSIBLE RIM  
PANIC LATCH



H0404001 - Silver

**BRITON 377E**  
REBATED DOUBLE DOOR  
PANIC SET



H0403601 - Silver

**BRITON 379E-N**  
MORTICE PANIC  
NIGHTLATCH



H0404005 - Silver

**BRITON 1413E/KE**  
OUTSIDE ACCESS DEVICE  
KNOB VARIANT



H0401001 - Silver

**BRITON 1413E/LE**  
OUTSIDE ACCESS DEVICE  
LEVER VARIANT



H0402001 - Silver

**BRITON 1438E**  
REVERSIBLE PUSH-PAD  
RIM LATCH



H0404501 - Silver

**BRITON 372E**  
PUSH PAD  
VERTICAL BOLT



H0404521 - Silver

**BRITON 389E-N** PUSH  
PAD MORTICE  
NIGHTLATCH



H0404531 - Silver



## Briton 560 Pushbar Range

**561 ONE POINT  
LOCKING**



H0407001 - Silver

**562-V TWO OR  
THREE POINT  
LOCKING**



H0407011 - Silver

**562-S THREE  
POINT LOCKING WITH  
TWO SIDE PULLMANS**



H0407021 - Silver

**562 -VS THREE  
POINT LOCKING WITH  
ONE UPPER & ONE  
SIDE PULLMAN**



H0407031 - Silver

## Briton 570 Touchbar Range

**571  
ONE POINT LOCKING**



H0407041 - Silver

**572-V  
TWO OR THREE  
POINT LOCKING**



H0407051 - Silver

**572-S  
THREE POINT  
LOCKING WITH TWO  
SIDE PULLMANS**



H0407061 - Silver

**572-VS  
THREE POINT LOCKING  
WITH ONE UPPER &  
ONE SIDE PULLMAN**



H0407071 - Silver

### ACCESSORIES FOR 370 SERIES

- H0401501 - Briton Add Alarm L/H
- H0401511 - Briton Add Alarm R/H
- H0403011 - Extended Shoots
- H0404051 - Box Keeper for 378 Latches

### ACCESSORIES FOR 560 & 570 RANGE

ALARM SWITCH KIT TO CONNECT TO AUDIO/VISUAL OR DOOR CONTROL SYSTEMS

- H0407081 - 566-AK To Suit 560 Range
- H0407091 - 576-AK To Suit 570 Range
- H0407101 - 576-RE Extended Shoots For 560/570 Range

**Fire Door Hardware**

**REDLAM SECURITY BOLT**



152 x 57mm Cast Aluminium  
 H0146001 - Bolt  
 H0146011 - Spare Tubes

**MORTICE ESCAPE DEAD LOCK 3 LEVER**

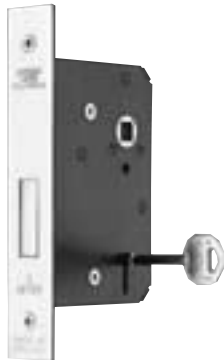

H0051501 - 76mm SCP  
 H0051502 - 76mm Brass

**EURO PROFILE CYLINDER MORTICE ESCAPE DEAD LOCK**



H0055501 - 76mm SCP  
 H0055502 - 76mm Brass

**UNION 8070 EMERGENCY EXIT DOME FOR USE WITH OVAL & EURO CYLINDERS**



H0055671

**GUARDIAN MORTICE ESCAPE DEAD LOCK CASE SIZE 101MM DEPTH 108MM HIGH BACKSET 57MM**



H0055601 - Lever Type G9064 SSS  
 H0055611 - Euro Profile G9764 SSS

**Accessories for Guardian Escape Locks not Supplied with Locks**

**FULL FRAME MORTICE KEY PATTERN**

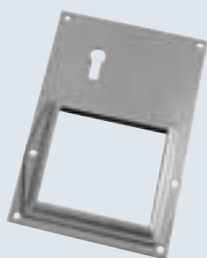

H0055621 - G9067 Green

**FULL FRAME EURO PROFILE PATTERN**

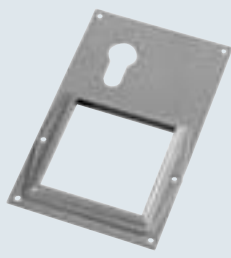

H0055631 - G9068 Green

**STANDARD FRAME**

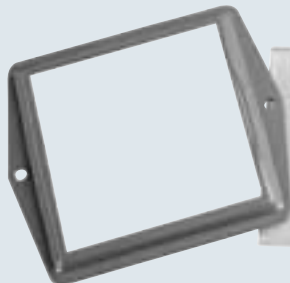

H0055641 - G9066 Green

**Replacement Glass**



H0055651

**HAMMER & CHAIN**



H0055661 - G9071

**Fire Door Controls**

**BRITON 996 DUAL  
FUNCTION UNIT  
HOLD OPEN OR FREE SWING**



- HO410501 - APP 1/61 Silver Pull Side  
For Door Widths up to 930mm
- HO410511 - APP 66 Silver Push Side  
For Door Widths up to 760mm

**DORMA BTS80F FLOOR SPRING  
24v DC SPEED CONTROL & LATCH  
ACTION. SUITABLE FOR FIRE & SMOKE  
DOORS**



- HO426010 Mechanism Only
- HO426022 Standard Spindle

**DORMA BTS80FLB FLOOR SPRING 24v  
DC WITH ELECTRO HYDRAULIC FREE  
SWING FEATURE**

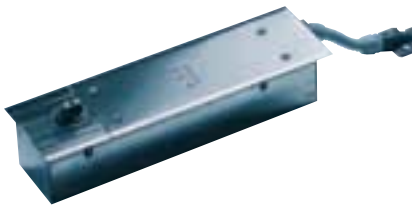

- HO426031 Mechanism Only
- HO426022 Standard Spindle

**T592 EMF 24v DC  
CAM ACTION WITH ELECTRO HYDRAULIC HOLD OPEN  
ACTION**

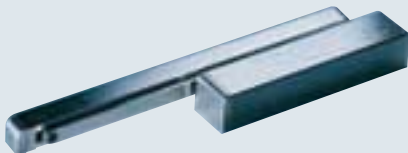

- HO426051 - Silver

Variable Power  
EN 2 - 4

Body Size  
240w x 60h x 51d

Hold Open Angle  
80 to 120°

**BRITON 2934TE  
ELECTROMAGNETIC DOOR CLOSER**



- HO410601 - Silver 2000 Cover
- HO410602 - Silver SC Cover

**BRITON ELECTRO MAGNETIC  
DOOR HOLDER**



- HO409001 - 533 Silver  
For Flush Mounting
- HO409011 - 534 Silver  
For Floor mounting
- HO409002 - 533C Surface  
Mounting Box

**DORMA BTS80EMB FLOOR SPRING  
24v DC ELECTRO MAGNETIC ACTION**



- HO426021 Mechanism Only
- HO426022 Standard Spindle

**DORMA TS73EMF 24v DC ELECTRO  
MAGNETIC HOLD OPEN**



Body Size  
320w x 45.5h x 60d

Hold Open Angle  
75 to 180°

- HO427001 Silver Power Size EN 4
- HO427011 Silver Power Size EN 5
- HO427021 Silver Power Size EN 6

**DORMA EM100A 24v DC WALL MOUNTED  
MAGNETIC DOOR HOLDER**



- HO426061 Door Holder White
- HO426071 MAG Standard Armature
- HO426072 MAT Buffer Armature
- HO426073 MAW Adjustable Angled Armature

Rigid Plastic



H6800001 - 400 x 150  
H6800002 - 600 x 200



H6800011 - 400 x 150  
H6800012 - 600 x 200



H6800021 - 400 x 150  
H6800022 - 600 x 200



H6800031 - 400 x 150  
H6800032 - 600 x 200



H6800041 - 400 x 150  
H6800042 - 600 x 200



H6800051 - 400 x 150  
H6800052 - 600 x 200



H6800061 - 400 x 150  
H6800062 - 600 x 200



H6800071 - 400 x 150  
H6800072 - 600 x 200



H6800081 - 150 x 150  
H6800082 - 200 x 200



H6800091 - 750 x 150



H6800092 - 750 x 150



H6800101 - 400 x 125  
H6800102 - 600 x 150



H6800111 - 300 x 150  
H6800112 - 400 x 200



H6800121 - 300 x 200  
H6800122 - 600 x 400



H6800131 - 300 x 200  
H6800132 - 600 x 400



H6800141 - 125 x 125  
H6800142 - 150 x 150  
H6800143 - 200 x 200



H6800151 - 125 x 125  
H6800152 - 150 x 150  
H6800153 - 150 x 150



H6800161 - 400 x 150  
H6800162 - 600 x 200



H6800171 - 400 x 150  
H6800172 - 600 x 200



H6800181 - 400 x 150  
H6800182 - 600 x 200



H6800191 - 400 x 150  
H6800192 - 600 x 200



H6800201 - 400 x 150  
H6800202 - 600 x 200



H6800211 - 400 x 150  
H6800212 - 600 x 200



H6800221 - 400 x 150  
H6800222 - 600 x 200



H6800231 - 400 x 150  
H6800232 - 600 x 200



H6800241 - 100 x 150



H6800242 - 100 x 150



H6800243 - 100 x 150



H6800244 - 100 x 150



H6800251 - 100 x 150



H6800252 - 100 x 150



H6800261 - 200 x 300



H6800271 - 100 x 150



H6800281 - 300 x 100



H6800291 - 300 x 100



H6800301 - 300 x 100



H6800311 - 300 x 100  
H6800312 - 300 x 200



H6800321 H6800322 - 75 x 150 - 75 x 150

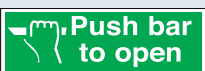

H6800331 - 300 x 150



H6800341 - 300 x 100



H6800342 - 300 x 100



H6800343 - 100 x 100



H6800351 - 300 x 100  
H6800352 - 600 x 100



H6800361 - 300 x 75



H6800362 - 300 x 75

**Rigid Plastic**

**WHAT YOU SHOULD KNOW**

**EN3 FIRE EXTINGUISHER COLOUR CODE**

H6800371 - 350 x 200  
H6800372 - 600 x 370

H6800373 - 125 x 90 Pocket Guide  
(Pocket guides supplied in packs of 10s)

**DRY POWDER**

H6800374 - 202 x 82

**FOAM SPRAY**

H6800375 - 202 x 82

**WATER**

H6800376 - 202 x 82

**CO2**

H6800377 - 202 x 82

**Fire blanket**

H6800378 - 202 x 82

**FIRE HOSE REEL**

H6800379 - 202 x 82

**Fire extinguisher**

H6800381 - 300 x 100  
H6800382 - 450 x 150

**Fire alarm call point**

H6800383 - 300 x 100

**Fire hose reel**

H6800384 - 300 x 100

**Fire extinguisher keep clear**

H6800385 - 300 x 100

**Fire point**

H6800386 - 350 x 150  
H6800387 - 400 x 200

**FIRE POINT**

H6800388 - 200 x 300  
H6800389 - 300 x 400

**Fire hose reel**  
To operate  
Run out hose  
Water will turn on  
automatically.  
Operate control  
at nozzle.

H6800391 - 200 x 250

**Fire hose reel**  
To operate  
Turn wheel Va Ve  
anti-clockwise and  
run out hose.  
Turn on at nozzle.

H6800392 - 200 x 250

**CAUTION!**

**CO2**

Do NOT enter unless automatic release is isolated.

When alarm sounds evacuate hazard area.

After CO2 discharge do NOT re-enter until thoroughly ventilated.

H6800401 - 200 x 200

**CAUTION!**

**HFC 227ea**

This area is protected by a gaseous fire extinguishing system.

When alarm sounds or upon gas discharge evacuate hazard area immediately.

After discharge do NOT re-enter until thoroughly ventilated.

H6800402 - 200 x 200

**CAUTION!**

**FM-200**

This area is protected by a gaseous fire extinguishing system.

When alarm sounds or upon gas discharge evacuate hazard area immediately.

After discharge do NOT re-enter until thoroughly ventilated.

H6800403 - 200 x 200

**Self Adhesive**

(Supplied 100 labels on a roll, cost effective and easy to use, ideal for large identification schemes to comply with new regulations.)



H6800411 - 100 x 100



H6800412 - 100 x 100



H6800413 - 100 x 100



H6800414 - 100 x 100



H6800421 - 100 x 100



H6800422 - 100 x 100



H6800423 - 100 x 100

**Fire door keep shut**

H6800431 - 80 x 80  
H6800432 - 100 x 100  
H6800433 - 150 x 150

**Fire door keep locked shut**

H6800441 - 80 x 80  
H6800442 - 100 x 100  
H6800443 - 150 x 150

**Keep Locked shut**

H6800451 - 100 x 100  
H6800452 - 150 x 150

**Automatic fire door Keep clear**

H6800461 - 80 x 80  
H6800462 - 100 x 100  
H6800463 - 150 x 150

**Fire door keep closed**

H6800471 - 100 x 100  
H6800472 - 150 x 150

**This door will close automatically when the fire alarm operates**

H6800481 - 100 x 100  
H6800482 - 150 x 150

**In the event of fire this door to be kept closed**

H6800491 - 100 x 100  
H6800492 - 150 x 150

**Please close this door**

H6800511 - 100 x 100  
H6800512 - 150 x 150

**Close these doors at night**

H6800521 - 100 x 100  
H6800522 - 150 x 150

**Fire escape keep clear**

H6800531 - 100 x 100  
H6800532 - 150 x 150

**Please switch off lights on leaving**

H6800541 - 100 x 100  
H6800542 - 150 x 150

**Switch off when not in use**

H6800551 - 100 x 100  
H6800552 - 150 x 150

**Rigid Plastic**

**Fire action**

**If YOU DISCOVER A FIRE:**

- 1) Sound the alarm
- 2) If possible notify the fire using the facilities provided
- 3) Report to person in charge of assembly point

**If YOU HEAR THE FIRE ALARM:**

- 1) Leave the building by the nearest available exit
- 2) Close all the doors behind you
- 3) Report to person in charge of assembly point

Do not stop to collect personal belongings. Do not use the lift. Never re-enter the building for any reason unless authorised to do so. Do not take risks.

H6800661 - 200 x 300  
H6800662 - 400 x 600

**In case of fire break glass**

**Fire action**

**If YOU DISCOVER A FIRE:**

- 1) Sound the alarm
- 2) If possible notify the fire using the facilities provided
- 3) Report to person in charge of assembly point

**If YOU HEAR THE FIRE ALARM:**

- 1) Leave the building by the nearest available exit
- 2) Close all the doors behind you
- 3) Report to person in charge of assembly point

Do not stop to collect personal belongings. Do not use the lift. Never re-enter the building for any reason unless authorised to do so. Do not take risks.

H6800671 - 200 x 300  
H6800672 - 400 x 600

**Fire action**

**Operate the nearest fire alarm**

**Leave the building by the nearest available exit**

**Report to the person in charge of the assembly point at:**

**Do not use lift**  
Do not re-enter the building until authorised to do so

H6800681 - 200 x 300

**In case of fire**

**Do not use lift**

**Use the stairs**

H6800691 - 200 x 300

**Fire door keep shut**

H6800651 - 35 x 400

Fire Door Signage



**Rigid Self Adhesive**



H6800701 - Gold 100 X 150  
H6800702 - Satin 100 X 150



H6800711 - Gold 100 X 150  
H6800712 - Satin 100 X 150



H6800721 - Gold 100 X 150  
H6800722 - Satin 100 X 150



H6800731 - Gold 100 X 150  
H6800732 - Satin 100 X 150



H6800831 - Gold 100 X 150  
H6800832 - Satin 100 X 150

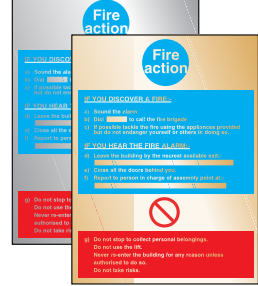

H6800931 - Gold 200 X 300  
H6800932 - Satin 200 X 300



H6800941 - Gold 350 X 150  
H6800942 - Satin 350 X 150



H6800951 - Gold 400 X 150  
H6800952 - Satin 400 X 150



H6800961 - Gold 400 X 125  
H6800962 - Satin 400 X 125



H6800971 - Gold 400 X 150  
H6800972 - Satin 400 X 150



H6800981 - Gold 400 X 150  
H6800982 - Satin 400 X 150



H6800991 - Gold 400 X 150  
H6800992 - Satin 400 X 150

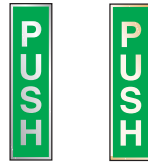

H6801001 - Gold 75 X 150  
H6801002 - Satin 75 X 150

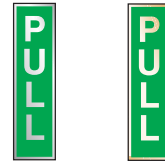

H6801011 - Gold 75 X 150  
H6801012 - Satin 75 X 150

**Pictograms Screw Fix**

RECTANGULAR 150 x 100MM

CIRCULAR DISCS 75MM DIAMETER



H6801021 - SAA  
H6801022 - PB



H6801031 - SAA  
H6801031 - PB



H6801041 - SAA  
H6801041 - PB



H6801051 - SAA  
H6801052 - PB  
H6801053 - PSS  
H6801054 - SSS



H6801061 - SAA  
H6801062 - PB  
H6801063 - PSS  
H6801064 - SSS



H6801065 - SAA  
H6801066 - PB  
H6801067 - PSS  
H6801068 - SSS



H6801101 - SAA  
H6801102 - PB  
H6801103 - PSS  
H6801104 - SSS



H6801091 - SAA  
H6801092 - PB  
H6801093 - PSS  
H6801094 - SSS



H6801081 - SAA  
H6801082 - PB  
H6801083 - PSS  
H6801084 - SSS



H6801071 - SAA  
H6801072 - PB  
H6801073 - PSS  
H6801074 - SSS

**Rigid Plastic**



H6801111 - 300 x 100



H6801112 - 300 x 100



H6801113 - 300 x 100



H6801114 - 300 x 100



H6801115 - 300 x 100



H6801121 - 300 x 100



H6801122 - 300 x 100



H6801123 - 300 x 100



H6801124 - 300 x 100



H6801131 - 300 x 100

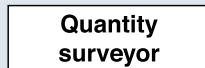

H6801132 - 300 x 100



H6801133 - 300 x 100

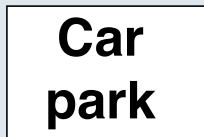

H6801134 - 300 x 200

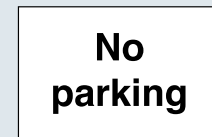

H6801135 - 300 x 200

**Rigid Plastic**



H6801141 - 150 x 50  
H6801142 - 300 x 100  
H6801143 - 600 x 200



H6801151 - 300 x 100  
H6801152 - 600 x 200  
H6801153 - 200 x 300



H6801161 - 300 x 100  
H6801162 - 600 x 200



H6801171 - 300 x 100  
H6801172 - 600 x 200



H6801181 - 300 x 100  
H6801182 - 600 x 200



H6801191 - 300 x 100  
H6801192 - 600 x 200



H6801201 - 75 x 150  
H6801202 - 300 x 100  
H6801203 - 600 x 200



H6801211 - 100 x 100  
H6801212 - 200 x 200  
PR35 400 x 400  
H6801221 - 100 x 100  
H6801222 - 200 x 200  
PR54 400 x 400



H6801231 - 200 x 300  
H6801232 - 400 x 600



H6801241 - 200 x 300  
H6801242 - 400 x 600



H6801251 - 200 x 300  
H6801252 - 400 x 600



H6801261 - 200 x 300  
H6801262 - 400 x 600



H6801271 - 200 x 300  
H6801272 - 400 x 600



H6801281 - 200 x 300  
H6801282 - 400 x 600



H6801291 - 200 x 300  
H6801292 - 400 x 600



H6801301 - 200 x 300  
H6801302 - 400 x 600



H6801311 - 200 x 300  
H6801312 - 400 x 600



H6801321 - 200 x 300  
H6801322 - 400 x 600



H6801331 - 400 x 600



H6801332 - 400 x 600



H6801333 - 400 x 600



H6801334 - 400 x 600



H6801341 - 600 x 450

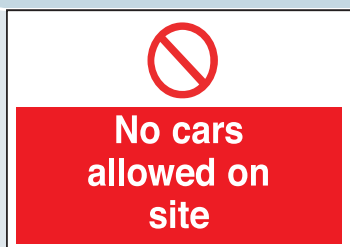

H6801342 - 600 x 450



H6801343 - 600 x 450

Rigid Plastic



H6801353 - 200 x 300  
H6801354 - 400 x 600



H6801355 - 200 x 300  
H6801356 - 400 x 600



H6801357 - 200 x 300  
H6801358 - 400 x 600



H6801359 - 200 x 300  
H6801360 - 400 x 600



H6801371 - 300 x 100  
H6801372 - 600 x 200



H6801373 - 300 x 100  
H6801374 - 600 x 200



H6801375 - 300 x 100  
H6801376 - 600 x 200



H6801377 - 300 x 100  
H6801378 - 600 x 200

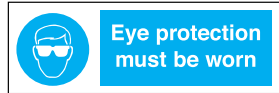

H6801381 - 300 x 100  
H6801382 - 600 x 200



H6801383 - 300 x 100  
H6801384 - 600 x 200



H6801385 - 300 x 100  
H6801386 - 600 x 200



H6801391 - 600 x 450



H6801392 - 600 x 450

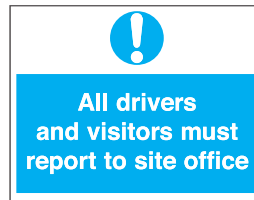

H6801393 - 600 x 450



H6801394 - 600 x 450

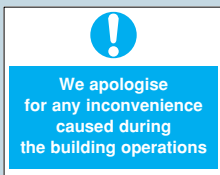

H6801401 - 600 x 450



H6801402 - 600 x 450

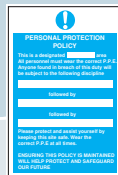

H6801403 - 400 x 600

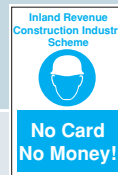

H6801404 - 400 x 600

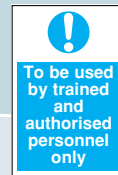

H6801405 - 200 x 300  
H6801406 - 400 x 600



H6801407? - 400 x 600 (face size) (Foamex)



H6801501 - 600 x 450



H6801502 - 600 x 450



H6801503 - 300 x 300



H6801504 - 300 x 300



H6801505 - 300 x 300

Rigid Plastic And Foamex

Signs and Nameplates



H6801511 - 400 x 300



H6801512 - 400 x 300



H6801513 - 400 x 300



H6801514 - 400 x 300



H6801515 - 600 x 200



H6801521 - 200 x 300  
H6801522 - 400 x 600



H6801523 - 200 x 300  
H6801524 - 400 x 600



H6801525 - 200 x 300  
H6801526 - 400 x 600



H6801527 - 200 x 300  
H6801528 - 400 x 600



H6801529 - 200 x 300  
H6801530 - 400 x 600



H6801541 - 600 x 450



H6801542 - 600 x 450



H6801543 - 600 x 450



H6801561 - 600 x 450



H6801562 - 600 x 450



H6801563 - 600 x 450



H6801564 - 600 x 450



H6801571 - 400 x 600  
(face size) Foamex



H6801572 - 600 x 400  
(face size) Foamex



H6801573 - 600 x 400  
(face size) Foamex



H6801581 - 800 x 600mm Rigid Plastic



H6801582 - 800 x 600mm Rigid Plastic

**Intumescent Materials**

**ASTRO STRIP  
INTUMESCENT STRIPS**



10 x 4mm

- H0850601 - 1050mm White
- H0850611 - 1050mm Brown
- H0850621 - 2100mm White
- H0850631 - 2100mm Brown

**ASTRO STRIP  
INTUMESCENT SMOKE SEAL**



10 x 4mm Grey Brush

- H0850641 - 1050mm White
- H0850651 - 1050mm Brown
- H0850661 - 2100mm White
- H0850671 - 2100mm Brown

Apart from the stock sizes shown here we can supply a selection of intumescent strips as shown below.

**Colour options**

- Light - Brown - Red - Black
- Cream - Grey - Silver
- Wood Effect

**Sizes**

12 x 4mm-15 x 4mm-20 x 4mm  
25 x 4mm-30 x 4mm-38 x 4mm  
All the above are available in either 1050mm or 2100mm lengths.

**Brush Seals**

Brush seals - A range of sizes and colours available.

**Neoprene seals**

Single & Twin Blade or Bubble Seal

**INTUMESCENT LETTER  
BOX LINER**

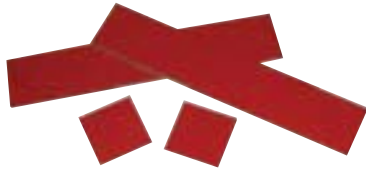

H0850691 -  
To suit aperture of maximum size  
250 x 250mm  
Red

**INTUMESCENT 30 OR 60MM  
SINGLE FIRE DOOR SET**

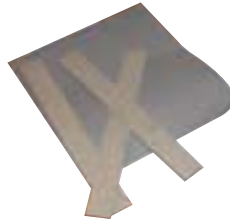

H0850692 -  
Consists of 3 x Hinge Strips  
1 x Lock Strip  
1 x Door Closer Strip

**INTUMESCENT FIRE RATED  
AIR TRANSFER GRILLES**



For 1/2 Hour FIRE RATED SYSTEMS  
Various Sizes Available To Order

**INTUMESCENT PIPE COLLARS**



AVAILABLE TO ORDER

**INTUMESCENT  
GLAZING TAPE**

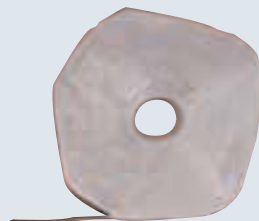

H0850693 - White  
15 mtr coil

**INTUMESCENT PIPE WRAPS**



AVAILABLE TO ORDER

**INTUMESCENT PUTTY**

Non setting putty for up to  
4 hours protection  
Available in 1kg and 20kg  
tubs

AVAILABLE TO ORDER

**INTUMESCENT PILLOWS**



AVAILABLE TO ORDER

**INTUMESCENT  
ACRYLIC MASTIC**



H0850694 - 310ml

**INTUMESCENT  
EXPANDING FOAM**



H0850695 - 750ml Can



**Fire Safety Equipment**

**EMERGENCY KEY BOX**



127mm Diameter  
 H0781501 - Red Plastic  
 H0781511 - Spare Glass

**EMERGENCY KEY BOX**



150 x 130 x 30mm  
 H0782001 -  
 H0782002 - Spare Glass

**EMERGENCY KEY BOX**



123 x 162 x 50mm  
 H0782251 -

**SMOKE & FIRE ALARM**

H9924046



**CARBON MONOXIDE ALARM**

H9924047



**FIRE EXTINGUISHERS WITH WALL BRACKET**



H0850801 - 6 Litre Water  
 H0850811 - 9 Litre Water  
 H0850821 - 4Kg Dry Powder  
 H0850831 - 6 Litre Foam Spray  
 H0850841 - 9 Litre Foam Spray  
 H0850842 - 2Kg CO<sup>2</sup> Carbon Dioxide  
 H0850843 - 5Kg CO<sup>2</sup> Carbon Dioxide  
 Brackets only for Extinguishers  
 H0850881 - To Suit Water/Powder/Foam  
 H0850891 - To Suit CO<sup>2</sup> Extinguishers

**FIRE BLANKETS**



H0850851 - 1 Metre x 1 Metre  
 H0850861 - 1.2 Metre x 1.2 Metre  
 H0850871 - 1.8 Metre x 1.2 Metre

**FIRE BUCKET**

Painted red with White Lettering on Black



Z4023503  
 Z4023507 - Fire Bucket Bracket

Fire Safety Products

**Casement Stays**

**DIE-CAST CASEMENT STAY WITH 2 PINS**



- H0500001 - 200mm Grey
- H0500011 - 255mm Grey
- H0500021 - 305mm Grey

**ALUMINIUM CASEMENT STAY WITH 2 PINS**



- H0500501 - 200mm SAA
- H0500511 - 255mm SAA
- H0500521 - 305mm SAA

**STEEL CASEMENT STAY WITH 2 PINS**



- H0503501 - 255mm Black
- H0503511 - 305mm Black

**DOUBLE ARM CASEMENT STAY SAA**



- H0501501 - 255mm SAA
- H0501511 - 305mm SAA

**BRASS SLIDING CASEMENT STAY**



- H0504001 - 255mm PB
- H0504011 - 305mm PB
- H0504003 - 255mm SCP
- H0504013 - 305mm SCP

**BRASS SLIDING CASEMENT STAY INWARD OPENING**



- H0504501 - 255mm PB
- H0504511 - 305mm PB

**STRAIGHT CASEMENT STAY PINS**



- H0513502 - Black Steel
- H0513503 - SAA
- H0513504 - Grey Die Cast
- H0513505 - PB

**OFFSET CASEMENT STAY PIN**



- H0514001 - Grey Die Cast

**CRANKED CASEMENT STAY PIN**



- H0514501 - Grey Die Cast
- H0514502 - PB
- H0514503 - SAA

**Caseament Fasteners**

**DIE CAST REVERSIBLE CASEMENT FASTENER**



H0510551 - Mortice Plate Grey  
H0510561 - Hook Plate Grey

**ALUMINIUM WEDGE PATTERN CASEMENT FASTENER**



H0507501 - SAA

**MALLEABLE IRON REVERSIBLE CASEMENT FASTENER**



H0512001 - Mortice Plate Black  
H0512011 - Hook Plate Black

**REVERSIBLE CASEMENT FASTENER**



H0511001 - Mortice Plate SCP  
H0511011 - Hook Plate SCP

**ALUMINIUM CASEMENT FASTENER**



Back Plate 73 x 25mm

H0511501 - SAA R/H  
H0511511 - SAA L/H

**ALUMINIUM CASEMENT FASTENER**



Back Plate 57 x 28mm

H0511551 - SAA R/H  
H0511561 - SAA L/H

**WELLINGTON LOCKING CASEMENT FASTENER**



H0508001 - SAA

**UNION 7122A5 LOCKING CASEMENT FASTENER**



H0508501 - SAA

**ALUMINIUM BOTTOM RAIL WEDGE FASTENER**



C/W Nylon Wedge

H0521501 - SAA R/H  
H0521511 - SAA L/H

**ZINC ALLOY BOTTOM RAIL MORTICE FASTENER**



C/W Nylon Wedge

H0522001 - Silver Coated R/H  
H0522011 - Silver Coated L/H

**MORTICE BUDGET LOCK**



H0522051 - Sheradised For Use with Bottom Rail Fastener Pattern H0522001/2

**Window Fittings**

**ASSAFLEX WINDOW STAYS**



H0516501 - 143mm Brown  
H0516502 - 254mm Satin  
H0516503 - 508mm Brown

**QUADILENT FANLIGHT STAY FOR RECESSED WINDOWS**



H0520001 - 127mm Silver  
H0520011 - 178mm Silver  
H0520021 - 229mm Silver

**QUADILENT FANLIGHT STAY FOR FLUSH FITTING WINDOWS**



H0520031 - 178mm Silver

**QUADILENT 3 POINT FANLIGHT OPENER**

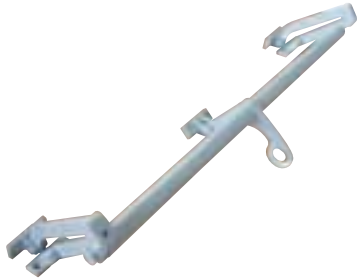

H0523001 - 457mm Silver

**ROLLER STAY**



H0520501 - 203mm SAA (Nylon Roller)  
H0520511 - 152mm Black  
H0520521 - 203mm Black

**SHADBOLT STAY**



H0521001 - 203mm Sanded Brass  
H0521011 - 255mm Sanded Brass

**AUTO RESTRICTOR STAY**



H0520041 - Silver

**FRICTION WINDOW STAY FOR SIDE HUNG CASEMENTS**

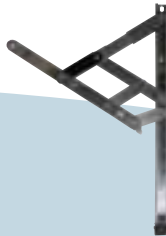

Up to 22kg

H0535701 - 305mm Stainless Steel

**FRICTION WINDOW STAY FOR TOP HUNG CASEMENTS**



Up to 16kg

H0535711 - 305mm Stainless Steel

**W6010A FACE FIXING PIVOT HINGES**



H0520051 - SCP

**W6010B SIDE & FACE FIXING PIVOT HINGES**



H0520052 - SCP

**W6010C SIDE FIXING PIVOT HINGES**



H0520053 - SCP

**Fanlight Fittings**

**ALLWAYS FANLIGHT  
OPENER  
CORD OPERATED**



H0526001 - 152mm BZP

**PRESTONS FANLIGHT OPENER  
CORD OPERATED**



H0526501 - 305mm BZP  
H0526511 - 381mm BZP

**LEGGOTTS FANLIGHT  
OPENER FOR LIGHT  
BOTTOM HUNG FANLIGHT**



H0527001 - 356mm

**LEGGOTTS SKYLIGHT  
OPENER**



H0527501 - 356mm Black

**ENDLESS CORD  
B QUALITY MEDIUM GREEN**



H0528001 - 1200mm Drop  
H0528011 - 1500mm Drop  
H0528021 - 2000mm Drop  
H0528031 - 2500mm Drop  
H0528041 - 3000mm Drop  
H0528051 - 4000mm Drop  
H0528061 - 5000mm Drop

**ENDLESS CORD  
D QUALITY STRONG GREEN**



H0528501 - 3000mm Drop  
H0528511 - 4000mm Drop  
H0528521 - 5000mm Drop  
H0528531 - 6000mm Drop  
H0528541 - 7000mm Drop

**FANLIGHT CATCH HOT  
PRESSED BRASS**



51 x 29mm

H0530001 - Sanded Brass  
H0530002 - Satin CP

**FANLIGHT CATCH**



57 x 32mm

H0530021 - White

**FANLIGHT CATCH**



41 x 44mm  
H0530501 - PB  
With Staples for Flush Fit

H0530502 - PB  
With Plate for Recessed Fanlights

**Poles**

H0613501 - 1350 x 30mm  
H0613511 - 1830 x 30mm  
H0613521 - 2100 x 30mm

**POLE HOOKS**



H0613003 - Brass

**CLEAT HOOKS**



H0612501 - 102mm, white  
H0612531 - 102mm, galvanised  
H0612541 - 76mm, brass  
H0612551 - 102mm, brass

Window Fittings



**Sash Window Fittings**

**FITCH PATTERN FASTENER**



H0531501 - Zinc Plated  
H0531503 - Electro Brass

**BRIGHTON PATTERN FASTENER**

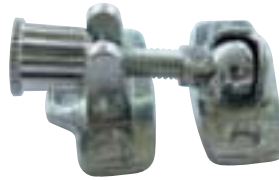

H0532001 - Zinc Plated  
H0532003 - Electro Brass

**STEEL SASH FASTENER**



H0532521 - Electro Brass  
H0532522 - Epoxy White

**BRASS SASH PIVOTS**

SUPPLIED AS A SET  
4 PIECES TO A SET



H0533501 - 51x22mm Dipped Brass  
H0533511 - 64x25mm Dipped Brass

**ACORN SASH STOP**



H0534001 - 32x13mm Brass

**WEEKES PATTERN  
WEIGHTED SASH STOP**



H0534501 - Sanded brass

**SASH SCREW**



H0535001 - 64x6mm PB  
H0535011 - 76x8mm PB  
H0535021 - 89x8mm PB

**BRASS SASH ROLLER**



H0543011 - 51x19mm Dipped Brass H0543501 - 44mm PB

**BRASS SASH EYE**



**BRASS SASH LIFT**



H0544001 - 44mm PB

**BRASS SASH LIFT**

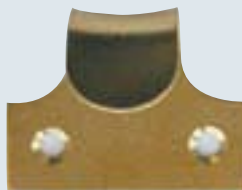

H0544501 - 51mm Electro Brasses

**STRONG BRASS SASH LIFT**



H0545001 - 64mm PB  
H0545002 - 64mm SCP

## Sash Window Fittings

### BRASS SASH HANDLE



125mm

H0545501 - PB  
H0545502 - Satin CP

### FLUSH LIFT FORGED ALUMINIUM FRAME



108 x 48mm

H0546001 - SAA

### FLUSH LIFT DOUBLE PRESSED FRAME



76 x 38mm

H0546501 - SAA 11mm deep  
H0547001 - PB 13mm deep

### FLUSH LIFT DOUBLE PRESSED FRAME



102 x 44mm

H0546511 - SAA 13mm deep  
H0547011 - PB 19mm deep

### FLUSH LIFT PRESSED ALUMINIUM



89 x 30 x 11mm

H0547501 - SAA

### CIRCULAR FINGER PULL



54 x 9mm

H0548001 - SAA

## Axle Pullies



Wheel Diameter 44mm  
Face Plate 117 x 25mm

H0550001 - Steel Face & Nylon Wheel



Wheel Diameter 44mm  
Face Plate 110 x 25mm

H0551001 - Nylon Wheel  
Galvanised Face Plate  
H0551002 - Nylon Wheel  
Brass Face Plate



Wheel Diameter 44mm  
Face Plate 126 x 28mm

H0551501 - Brass Wheel  
Galvanised Face Plate  
H0551502 - Brass Wheel  
Brass Face Plate  
Wheel Diameter 51mm  
Face Plate 126 x 28mm  
H0551511 - Brass Wheel  
Galvanised Face Plate  
H0551512 - Brass Wheel  
Brass Face Plate

Wheel Diameter 57mm  
Face Plate 126 x 28mm

H0551521 - Brass Wheel  
Galvanised Face Plate  
H0551522 - Brass Wheel  
Brass Face Plate

7 Window Fittings

## Sash Windows Fittings

**STEEL SASH CHAIN  
SHERADIZED WITH  
PHOSPHOR BRONZE RIVETS**



H0552001 - To Suit 31.8kg Sashes

H0552011 - To Suit 51kg Sashes

N.B Can only be used with 57mm Axle Pullies

**SASH CHAIN FITTINGS  
SUPPLIED IN SETS OF 4**



H0552501 - Washer & Split Pin Connector

H0553001 - Sash Weight Bolt Connector

**SASH CHAIN FITTINGS  
SUPPLIED IN SETS OF 4**



Washer & Split Pin Connector

H0553501 - Loop Weight Connector

H0554001 - Sash Plates & Bars

## Sash and Blind Cords

**PLAITED  
SASH CORD**

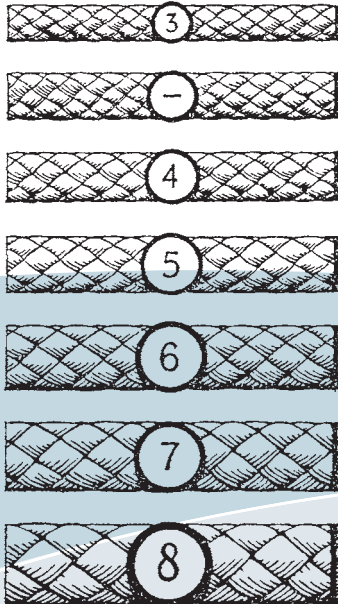

**Jute Plaited Sash Cord**

10 MTR Knots White  
H0555001 - Size 3  
H0555011 - Size 4  
H0555021 - Size 5

**Nylon Plaited Sash Cord**

10 MTR Knots Natural  
H0556001 - Size 3  
H0556011 - Size 4  
H0556021 - Size 5  
H0556031 - Size 6

**EVERLASTO WATERPROOF  
SASH CORD**

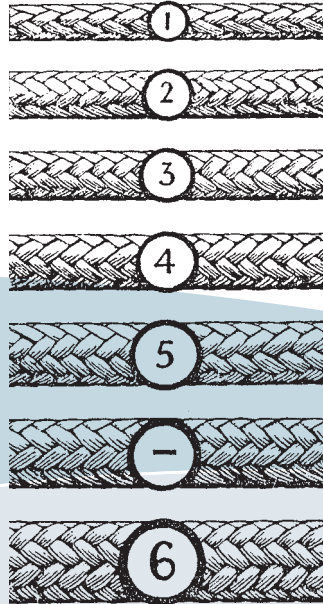

**Everlasto Blue Label**

10 MTR Knots Waxed  
H0557001 - Size 3  
H0557011 - Size 4  
H0557021 - Size 5  
H0557031 - Size 6

**Everlasto Red Label 'A' Quality**

10 MTR Knots Waxed  
H0557501 - Size 3  
H0557511 - Size 4  
H0557521 - Size 5  
H0557531 - Size 6

**SOLID BRAIDED  
SASH CORD**

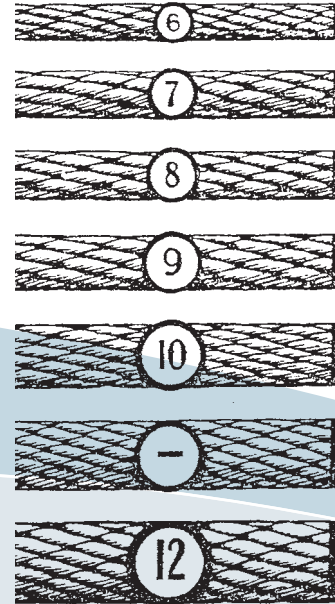

**Red Spot Braided Cotton Cord**

10 MTR Knots Polished  
H0556501 - Size 6  
H0556511 - Size 7  
H0556521 - Size 8

**Polythene Blind Cord White**

Size No2  
H0558001 - 2mm x 100 mtr  
Size No4  
H0558011 - 3mm x 100 mtr  
Size No5  
H0558021 - 4mm x 50 mtr  
Size No6  
H0558031 - 4.5mm x 50 mtr

## Sash Window Fittings

### MEAKINS SASH OPENER & FASTENER



H0535501 - Set Comprising-Fastener, 2 Pulleys, 2 Cord Plates, 4 handles, 8 Yards of Cord & Fixing Screws

Ordered Individually  
 H0535521 - Pulleys  
 H0535531 - Cord Plates  
 H0535541 - Handles  
 H0535551 - Cord

### BECLAWAT 95 ADJUSTABLE SPRING TAPE SASH BALANCES



Available in Side or Top Fixing

#### Side Fixing

H0542001 - 1.8 to 3.6kg  
 H0542011 - 2.7 to 4.5kg  
 H0542021 - 3.6 to 5.9kg  
 H0542031 - 4.5 to 7.3kg  
 H0542041 - 5.9 to 8.6kg  
 H0542051 - 7.3 to 10kg  
 H0542061 - 8.6 to 11.3kg  
 H0542071 - 10 to 12.2kg  
 H0542081 - 11.3 to 13.6kg



#### Top Fixing

H0542501 - 1.8 to 3.6kg  
 H0542511 - 2.7 to 4.5kg  
 H0542521 - 3.6 to 5.9kg  
 H0542531 - 4.5 to 7.3kg  
 H0542541 - 5.9 to 8.6kg  
 H0542551 - 7.3 to 10kg  
 H0542561 - 8.6 to 11.3kg  
 H0542571 - 10 to 12.2kg  
 H0542581 - 11.3 to 13.6kg

### UNIQUE SPIRAL SASH BALANCES Special order on completion of order form available upon request

#### STANDARD 58

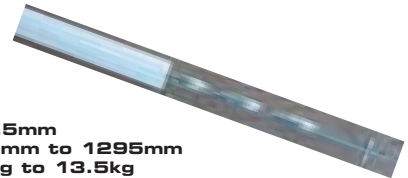

Tube Diameter 13.5mm  
 Length Range 178mm to 1295mm  
 Weight range 4.5kg to 13.5kg

#### HEAVY DUTY 58

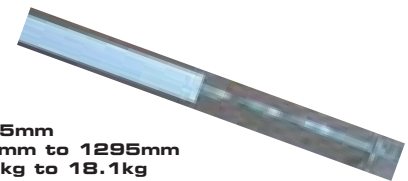

Tube Diameter 13.5mm  
 Length Range 254mm to 1295mm  
 Weight range 13.6kg to 18.1kg

#### LITE LIFT 20/30/40

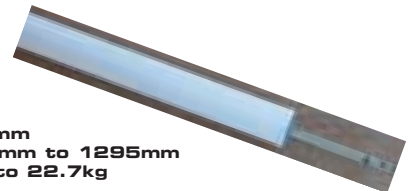

Tube Diameter 17mm  
 Length Range 330mm to 1295mm  
 Weight range 9kg to 22.7kg

#### LITE LIFT 50



Tube Diameter 17mm  
 Length Range 330mm to 1295mm  
 Weight range 22.71kg to 27.2kg

#### LITE LIFT 60

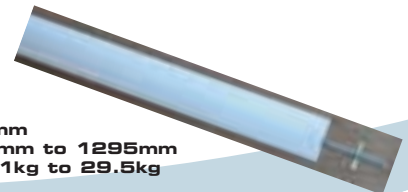

Tube Diameter 17mm  
 Length Range 330mm to 1295mm  
 Weight range 27.21kg to 29.5kg

#### LITE LIFT 70/80/90

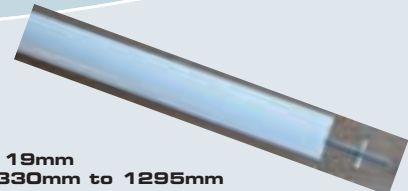

Tube Diameter 19mm  
 Length Range 330mm to 1295mm  
 Weight range 29.51kg to 45.5kg

Window Fittings

## Window Winding Gear

A range of manual and electrically operated systems enable the opening and closing of windows under user control.

### MANUAL SYSTEM

These can be used on most styles of windows to operate individual or multiple sets from a single wall mounted operator connected by conduit with inner cable to the opener on the window. when the handle is turned the inner cable is driven forward or backwards, thus opening or closing the window. depending on height limitations windows can be opened 250mm or 380mm. This system is extremely flexible as the conduct can be bent around obstacles to achieve your required design.

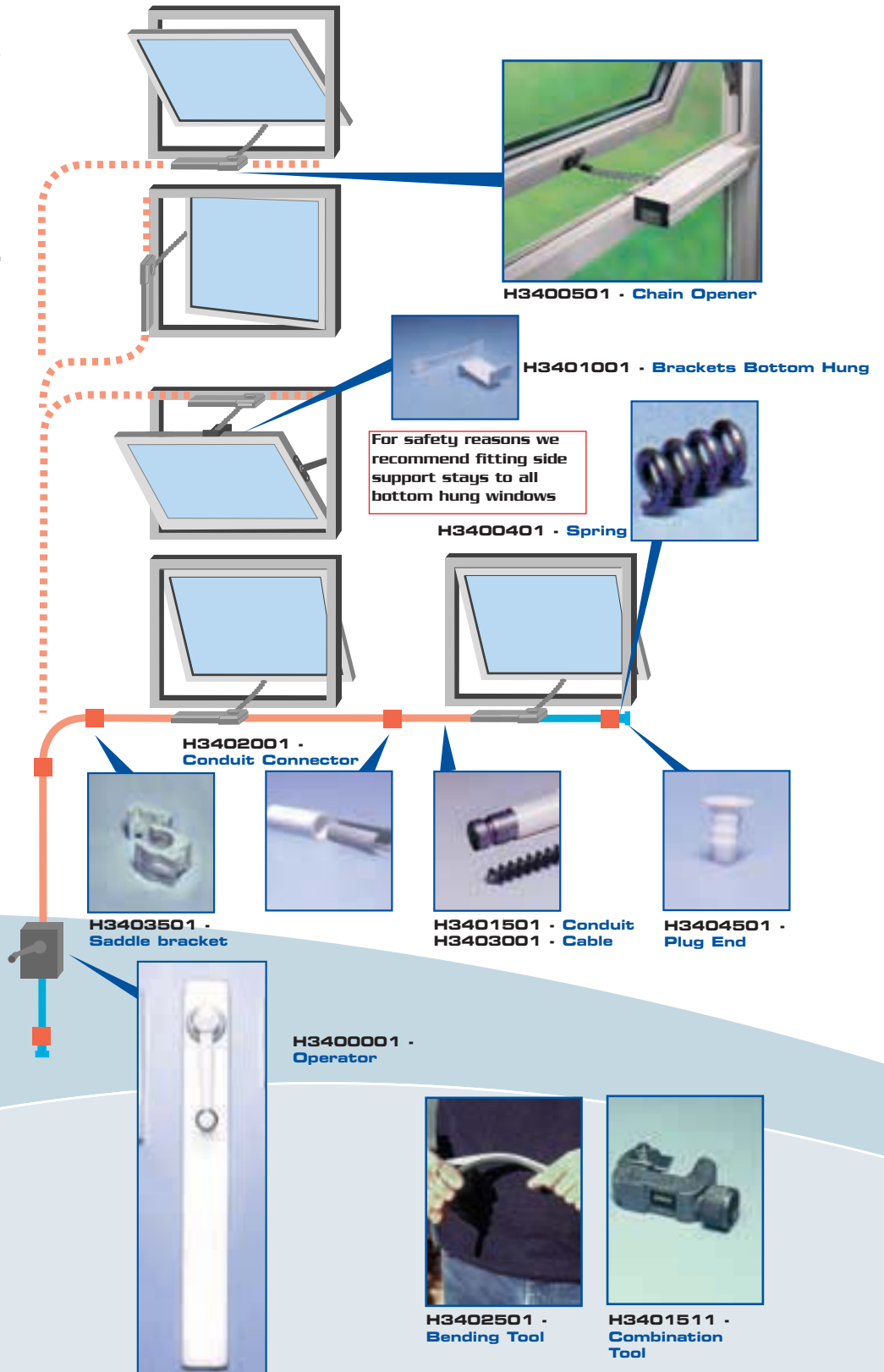

### DESIGN RULES

One chain opener per window up to 1000mm wide - over this size two openers are required.

The sum of openers and bends must not exceed six.

The Length of conduit and cable must not exceed 18 metres. Above this it is necessary to provide additional control units.



## Window Winding Gear

### CN1 SINGLE CHAIN & CN1-T TWIN CHAIN ACTUATORS



**STFW**  
Bottom hung fixing bracket

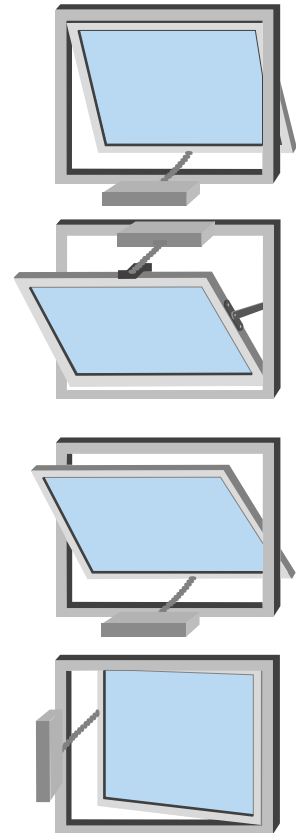

## Range of Switches

### S 50 RANGE



### PLS/NW SWITCH



**S10 Push Button**  
switch cartridge

**S10 Auto/man**  
switch cartridge



**S40 Surface**



**S30 Surface**

Electric window openers can be activated manually, either by a wall switch or a hand held remote control, or by various automatic sensors. There are 2 types of chain openers, the standard CN1 open has a single chain with a choice of 125mm, 250mm or 380mm travel. The CN1T twin chain opener, has two chains used for wider widows, and comes in 3 sizes 70mm, 1207mm and 1627mm with a 250mm travel. Both these units are available finished in either white, black or silver. Further details available upon request.

**Swish Curtain Track & Fittings**

**SWISH NYLONGLIDE**



**CURTAIN TRACK**  
Comprising Rail, 1 Bracket 3 Gliders Per foot run and End Stops

- H0750001 - 1.25 mtr
- H0750002 - 1.50 mtr
- H0750003 - 1.75 mtr
- H0750004 - 2.00 mtr
- H0750005 - 2.25 mtr
- H0750006 - 2.50 mtr
- H0750007 - 2.75 mtr
- H0750008 - 3.00 mtr
- H0750010 - 3.75 mtr
- H0750012 - 5.00 mtr

**CURTAIN WIRE**



- H0758001 - 100 Ft Coil
- H9945120 - 10 Ft Pack  
C/W Hooks & Eyes

**SWISH DELUXE**



**CURTAIN TRACK**  
Comprising Rail, 1 Bracket  
4 Gliders Per foot run and End Stops

- H0755001 - 1.25 mtr
- H0755002 - 1.50 mtr
- H0755003 - 1.75 mtr
- H0755004 - 2.00 mtr
- H0755005 - 2.25 mtr
- H0755006 - 2.50 mtr
- H0755007 - 3.00 mtr
- H0755009 - 3.75 mtr
- H0755011 - 5.00 mtr

**CURTAIN WIRE HOOKS  
ZINC PLATES**



- H0758501 - 200 Per Pack

**ACCESSORIES**



**N210W UNIVERSAL BRACKET**  
H0750501 - 5 Per pack

**ACCESSORIES**



**N182W GLIDER**  
H0755501 - 10 Per Per pack



**N182W GLIDER**  
H0751001 - 10 Per Per pack



**N290W END STOP**  
H0756001 - 1 Pair Per pack



**N290W END STOP**  
H0751501 - 1 Pair Per pack

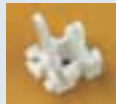

**D310WRJ LEVER LOCK BRACKET**  
H0756501 - 5 Per Pack



**N800W NYLON HOOKS**  
H0752501 - 25 Per Pack



**D602WRW CODING SET**  
H0757501 - Set

**CURTAIN WIRE EYES  
ZINC PLATED**



- H0759001 - 200 Per Pack
- PACKS OF CURTAIN HOOKS & EYES MIXED( 5 OF EACH)
- H9945209

**Cubicle Fittings** 304 Grade Stainless Steel all Supplied with standard Fixing

**FOOT ASSEMBLY ADJUSTABLE  
38MM DIAMETER**



H2240001 - TP30 For 13mm Diameter  
H2240002 - TP31 For 20mm Diameter

**FOOT ASSEMBLY TO SUIT  
13MM X 20MM BOARD**



H2240010 - TP32 22mm Diameter  
H2240011 - TP33 25mm Diameter  
H2240012 - TP34 32mm Diameter

**L BRACKET**



H2240020 - TP40

**U BRACKET**



H2240021 - TP41 For 13mm Board  
H2240022 - TP42 For 20mm Board

**GRAVITY HINGE  
ADJUSTABLE TO HOLD OPEN OR  
CLOSED**



H0444801 - TP10 L/H  
H0444811 - TP11 R/H

**INDICATOR BOLT**



H2240031 - TS20

**STAPLE**



H2240041 - TP21 For 13mm Board  
H2240042 - TP22 For 20mm Board

Cubicle Fittings

**Kitchen Fittings**

**DRAWER RUNNERS**



**H2240050**

**WORKTOP CLAMPS 65MM**



**H9945069 - Pair**

**CONCEALED HINGE 35MM METAL SPRUNG**



**H9945175 - Pair**

**WOODEN DOWELS**



**H9944007 - Trade pack 150 6mm x 30mm**

**CABINET CONNECTORS**



**H9945056 - Brown pack of 4**

**Sliding Door Locks**

**LOCK FOR SLIDING GLASS DOORS 1 KEY PER LOCK ALL TO PASS**



**H0027001 - Chrome Plated**

**RATCHET LOCK FOR FRAMELESS GLASS PANELS 114 x 32 x 22MM**



**H0027501 - Chrome**

**CYLINDER SLIDING DOOR LOCK FOR LIGHT WOODEN DOORS**



**19mm Diameter 22mm Projection  
H0026501 - Chrome**

## Sliding Door Locks

### CYLINDER SLIDING CUT CUPBOARD LOCK



63 x 44mm -  
Cylinder Projection 23mm  
H0026001 - L/H  
H0026002 - R/H

### SLIDING DOOR LATCH AND FURNITURE



H0068601 - 76MM Brass  
H0068602 - 76mm SCP

### SLIDING DOOR LOCK AND FURNITURE



H0068611 - 76mm Brass  
H0068602 - 76mm SCP

## Sliding Door Track

### BLACK PLASTIC DOUBLE CHANNEL FOR 6MM GLASS DOORS



2 Mtr Lengths

H0871501 - Top Channel  
20 x 13mm  
H0871511 - Bottom Channel  
20 x 10mm

### BLACK PLASTIC SINGLE CHANNEL FOR 6MM GLASS DOORS

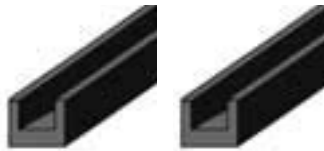

2 Mtr Lengths

H0872001 - Top Channel  
13 x 10mm  
H0872011 - Bottom Channel  
10 x 10mm

### ALUMINIUM DOUBLE CHANNEL WITH RIGID PVC INSERTS

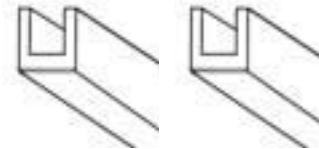

2 Mtr Lengths

H0872501 - Top Channel  
18 x 11mm  
H0872511 - Bottom Channel  
18 x 11mm

### POLISHED ALUMINIUM DOUBLE ROLLER CHANNEL FOR 6MM FRAMELESS GLASS DOORS



2 Mtr Lengths

H0873001 - Top Channel  
21 x 18mm  
H0873011 - Bottom Channel  
21 x 18mm

### POLISHED ALUMINIUM SINGLE ROLLER CHANNEL FOR 6MM FRAMELESS GLASS DOORS



2 Mtr Lengths

H0873501 - Top Channel  
13 x 18mm  
H0873511 - Bottom Channel  
13 x 18mm

### TOP GUIDE WITH RETRACTABLE NYLON ROLLER 10MM



H0874001 - Brass

# Sliding Door Track



## Henderson Sliding Door Gear

### SLIPPER DOOR GEAR

FOR KITCHEN CABINETS & BUILT IN FURNITURE  
STANDARD SET FOR 2 DOORS

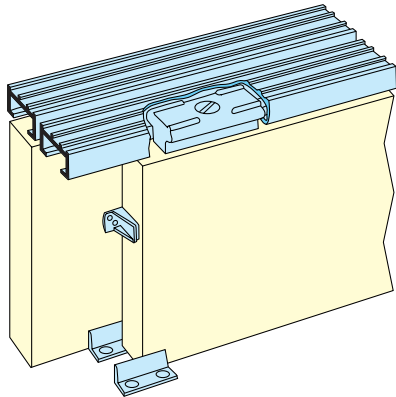

#### SPECIFICATIONS

Max Door Weight 9kg  
Max Door Width 900mm  
Max Door Height 1800mm  
Door Thickness 16.30mm



- H0882501 - Kit SS4 Track Length 1200mm
- H0882511 - Kit SS5 Track Length 1500mm
- H0882521 - Kit SS6 Track Length 1800mm

## ZENITH DOOR GEAR FOR 6MM SLIDING GLASS PANELS

STANDARD SET FOR 2 DOORS

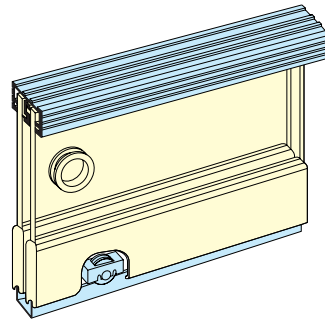

#### SPECIFICATIONS

Max Door Weight 25kg  
Max Door Width 900mm  
Max Door Area 1m<sup>2</sup>  
Door Thickness 6mm

- H0880501 - Kit Z12 Track Length 1200mm
- H0880511 - Kit Z15 Track Length 1500mm
- H0880521 - Kit Z18 Track Length 1800mm

#### Optional extras

- H0880551 - Cylinder Lock Left Hand
- H0880561 - Cylinder Lock Right Hand
- H0880571 - Finger Pull C.P
- H0880581 - PVC Dust Seal

## LORETTO DOOR GEAR FOR CUPBOARDS SLIDING ON BOTTOM ROLLERS

STANDARD SET FOR 2 DOORS

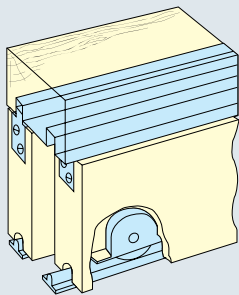

#### SPECIFICATIONS

Max Door Weight 23kg  
Max Door Width 900mm  
Max Door Height 1800mm  
Door Thickness 20-45mm

- H0880001 - Kit D4 Track Length 1200mm
- H0880011 - Kit D5 Track Length 1500mm
- H0880021 - Kit D6 Track Length 1800mm



## Henderson Sliding Door Gear

### SENATOR DOOR GEAR FOR LIGHTWEIGHT DOORS STANDARD SET FOR SINGLE DOOR

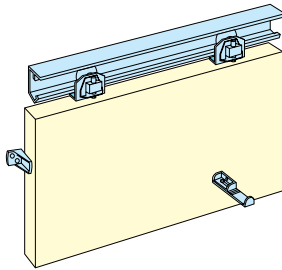

#### SPECIFICATIONS

Max Door Weight 30kg  
Max Door Width 900mm  
Max Door Height 2400mm  
Door Thickness 20-35mm



H0883001 - Kit SEN Track Length 1500mm

Optional extras  
H0883011 - Draughtseal



### PHANTOM DOOR GEAR SILENT GLIDE FOR TIMBER FRAMED OR COMPOSITE DOORS STANDARD SET FOR SINGLE DOOR

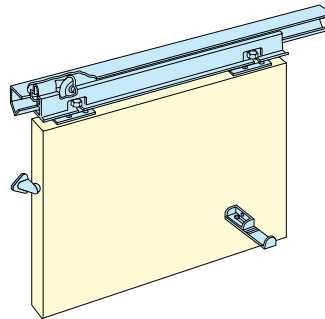

#### SPECIFICATIONS

Max Door Weight 45kg  
Max Door Width 610-915mm  
Max Door Height 2400mm  
Door Thickness 30-50mmmm

H0891501 - Kit PH Track Length 1525mm

### DOUBLE TOP GEAR FOR WARDROBE AND CUPBOARD DOORS STANDARD SET FOR 2 DOORS

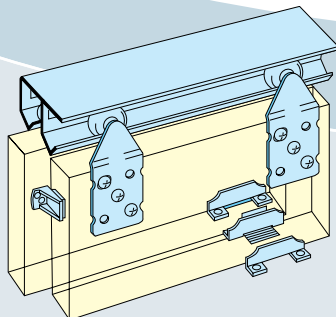

#### SPECIFICATIONS

Max Door Weight 45kg  
Max Door Width 900mm  
Max Door Height 2400mm  
Door Thickness 16-40mmmm

H0881501 - Kit W12 Track Length 1200mm  
H0881511 - Kit W15 Track Length 1500mm  
H0881521 - Kit W18 Track Length 1800mm  
H0881531 - Kit W24 Track Length 2400mm



**Henderson Sliding Door Gear**

**SINGLE TOP DOOR GEAR FOR WARDROBE & CUPBOARD DOORS STANDARD SET FOR A SINGLE DOOR**

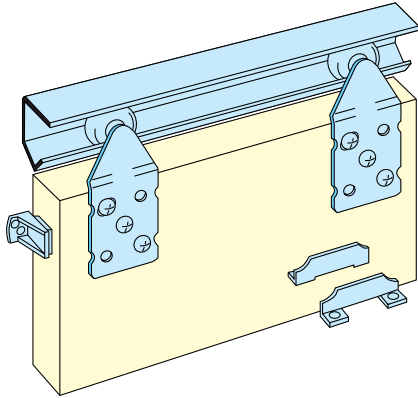

**SPECIFICATIONS**

Max Door Weight 45kg  
 Max Door Width 900mm  
 Max Door Height 2400mm  
 Door Thickness 16-40mm

- H0881001 - ST12 Track Length 1200mm
- H0881011 - ST15 Track Length 1500mm
- H0881021 - ST18 Track Length 1800mm



**MARATHON 55 DOOR GEAR FOR HEAVY DUTY DOMESTIC OR LIGHT COMMERCIAL DOORS STANDARD SET FOR ONE DOOR**

**SPECIFICATIONS**

Max Door Weight 55kg  
 Max Door Width 1500mm  
 Max Door Height 3000mm  
 Door Thickness 32-50mm

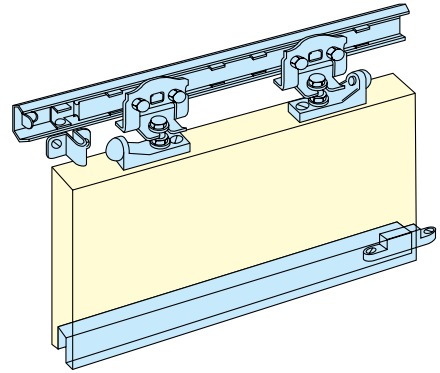

- H0883501 - Kit J2 Track Length 1219mm
- H0883511 - Kit J3 Track Length 1473mm
- H0883521 - Kit J4 Track Length 1702mm
- H0883531 - Kit J5 Track Length 1981mm
- H0883541 - Kit J6 Track Length 2438mm



**MARATHON 90 DOOR GEAR FOR HEAVY DUTY DOMESTIC OR LIGHT COMMERCIAL DOORS STANDARD SET FOR ONE DOOR**

**SPECIFICATIONS**

Max Door Weight 90kg  
 Max Door Width 1500mm  
 Max Door Height 3000mm  
 Door Thickness 32-50mm

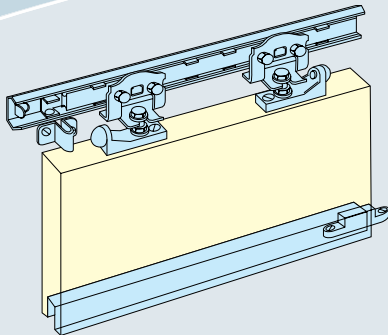

- H0884001 - Kit S3 Track Length 1473mm
- H0884011 - Kit S4 Track Length 1702mm
- H0884021 - Kit S5 Track Length 1981mm
- H0884031 - Kit S6 Track Length 3048mm



Optional Extras for marathon 55 & 90 Door Gear

- H0884511 - Pelmet 40P 1850mm length
- H0884521 - Pelmet End Caps EC40P Set of 2
- H0884531 - Soffit Brackets 3/40 Set of 5

## Henderson Sliding Door Gear

### Bi Fold Door Gear FOR FOLDING WARDROBE DOORS

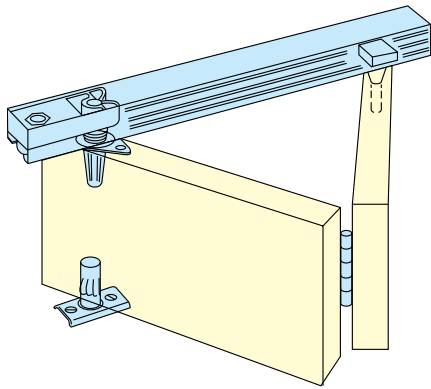

#### SPECIFICATIONS

Max Leaf Weight	14kg
Max Leaf Width	530mm
Max Leaf Height	2400mm
Leaf Thickness	20-35mm



- H0882001 - Kit B10/2 (2 Door Kit) Track Length 1000mm
- H0882011 - Kit B15/4 (4 Door Kit) Track Length 1500mm
- H0882021 - Kit B20/4 (4 Door Kit) Track Length 2000mm

### HENDERSON INDUSTRIAL DOOR GEAR FOR SINGLE TRACK WOODEN DOOR SYSTEMS. SYSTEMS FOR DOUBLE & TREBLE TRACK SYSTEMS CAN BE SUPPLIED TO SPECIAL ORDER

#### SYSTEM 290 FOR DOORS UP TO 150KG

##### No 290 TOP TRACK

- H0885001 - 1800mm
- H0885011 - 2500mm
- H0885021 - 3000mm

##### FACE FIXING BRACKETS

- H0885501 - 1A/290 Open
- H0885511 - Bracket End Clip
- H0885531 - 1A/X290 Joint Bracket

##### HANGERS

- H0886001 - 53KN Apron Fixing with Nylon Wheels
- H0886011 - 53KS Apron Fixing with Steel Wheels
- H0886021 - 52KN Angle Plate Fixing with Nylon Wheels
- H0886031 - 57KN Top Plate fixing with Nylon Wheels

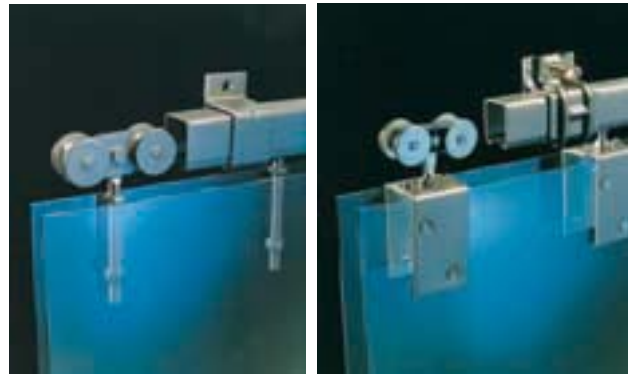

##### No 89 BOTTOM CHANNEL

- H0886501 - 1800mm
- H0886511 - 2500mm
- H0886521 - 3000mm

##### BOTTOM GUIDES

- H0887001 - 105R/89 Face Fixing

Sliding Door Gear



**Henderson Sliding Door Gear**

**HENDERSON INDUSTRIAL DOOR GEAR FOR SINGLE TRACK WOODEN DOOR SYSTEMS . SYSTEMS FOR DOUBLE & TREBLE TRACK SYSTEMS CAN BE SUPPLIED TO SPECIAL ORDER**

**SYSTEM 301  
FOR DOORS UP TO 300KG**

**No 301 TOP TRACK**

- H0887501 - 1800mm
- H0887511 - 2500mm
- H0887521 - 3000mm

**FACE FIXING BRACKETS**

- H0888001 - 1A/301 Open
- H0888011 - 1A/301EC End Clip  
(To convert Open Bracket to Closed)
- H0888021 - 1A/X301 Joint Bracket

**HANGERS**

- H0888501 - 53AS Apron Fixing with Steel Wheels
- H0888511 - 53AN Apron Fixing Nylon Wheels
- H0888521 - 52AS Angle Plate Fixing with Steel Wheels
- H0888531 - 52AN Angle Plate Fixing with Nylon Wheels

**No97 BOTTOM CHANNEL**

- H0889001 - 1800mm
- H0889011 - 2500mm
- H0889021 - 3000mm

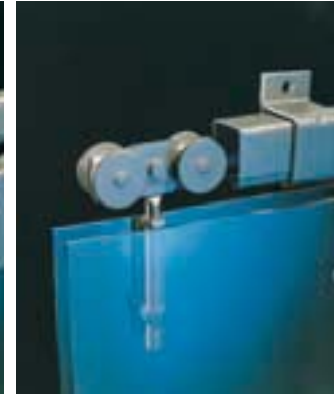

**BOTTOM GUIDES**

- H0889501 - 102/97 Face Fixing
- H0889501 - 106R/97 Bottom Fixing

**OPTIONAL EXTRAS FOR SYSTEMS 290 & 301**

**No 414 FLUSH PULL**



H0890001 - Grey

**No 863 Bow HANDLE**



H0890501 - Grey

**DOOR STOPS**

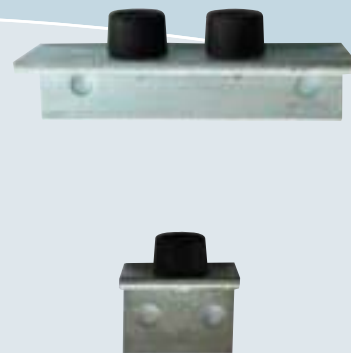

H0891001 - No 107 Double  
H0891011 - No 109 Single

Sliding Door Gear



**Draught Excluders**

**DURAFLEX RX100**  
A TRADITIONAL DESIGN OF  
LOW PROFILE THRESHOLD FOR  
EASY ACCESS

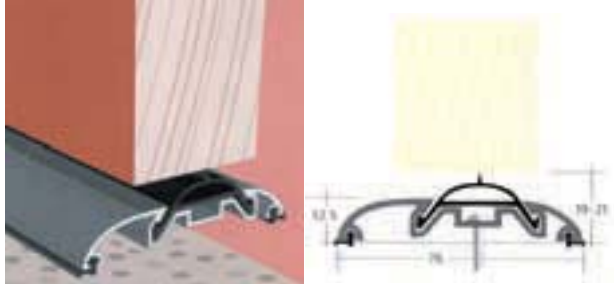

- H0854021 - 915mm Silver
- H0854022 - 915mm Brass
- H0854031 - 1000mm Silver
- H0854032 - 1000mm Brass
- H0854051 - 1219mm Silver
- H0854052 - 1219mm Brass
- H0854071 - 1829mm Silver
- H0854072 - 1829mm Brass

**ELEMENTEX SILL THE ORIGINAL TROUGH  
TYPE WEATHER BOARD**

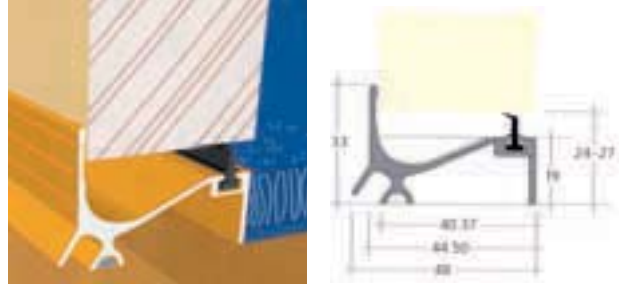

- H0855521 - 915mm Silver
- H0855522 - 915mm Brass
- H0855531 - 1000mm Silver
- H0855532 - 1000mm Brass
- H0855541 - 1219mm Silver
- H0855542 - 1219mm Brass

**DURAFLEX DM2000 EXTRA LOW SILL  
FOR PUBLIC &  
WHEELCHAIR ACCESS**

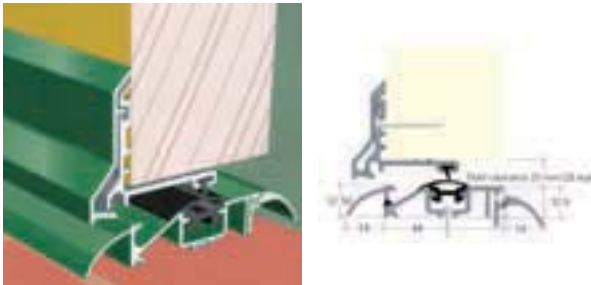

- H0855601 - 915mm Silver
- H0855602 - 915mm Brass

**DURAFLEX R15/0 WEATHER BAR THE  
ULTIMATE IN WIND & WEATHER  
PROTECTION**

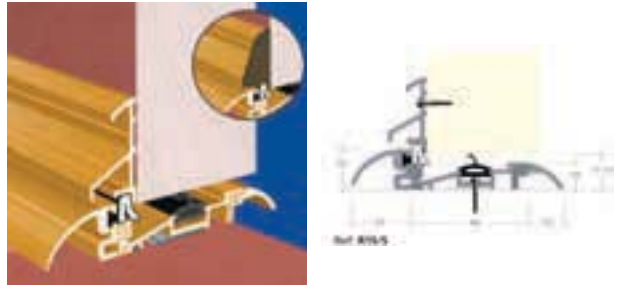

- H0855611 - 915mm Silver
- H0855612 - 915mm Brass

**DURAFLEX SL SEALBAR LOW, EXTRA LOW  
SILL FOR PUBLIC & WHEELCHAIR ACCESS**

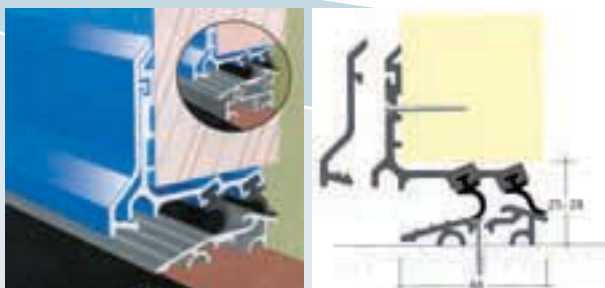

- H0855621 - 915mm Silver
- H0855622 - 915mm Brass

**DURAFLEX XL60 LOW PROFILE THRESHOLD  
FOR OUTWARD OPENING HINGED UP & OVER  
ROLLER DOORS & FRENCH WINDOWS**



- H0855631 - 915mm Silver
- H0855632 - 915mm Brass

N.B. ALL THE ABOVE PRODUCTS ARE AVAILABLE IN OTHER SIZES AND FINISHES TO ORDER

**Draught Excluders**

**DURAFLEX DK71 WEATHERBOARD**

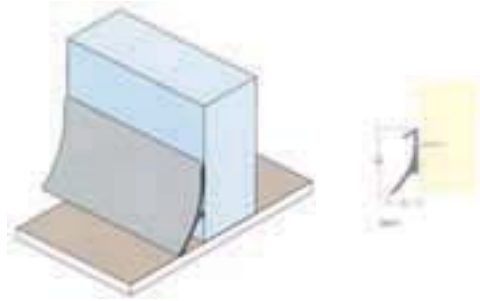

H0855021 - 915mm Silver  
H0855022 - 915mm Brass

**DURAFLEX DK91 WEATHERBOARD**

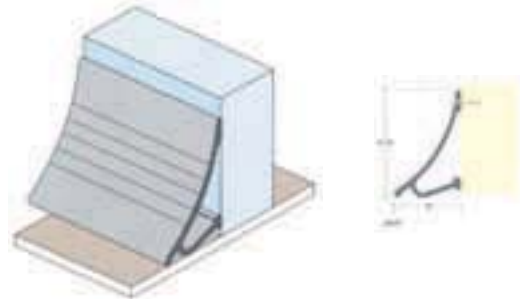

H0855031 - 915mm Silver  
H0855032 - 915mm Brass

**DURAFLEX DK30 DURASTRIP ECONOMIC COMPLETE DOOR FRAME DRAUGHT EXCLUDER KIT**

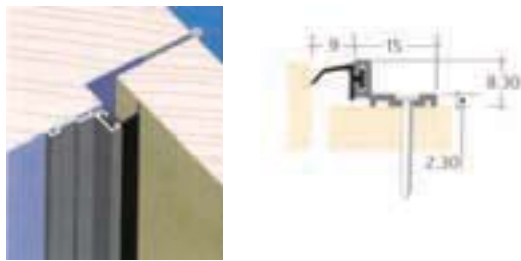

H0852001 - 5100mm Silver  
H0852002 - 5100mm Brass

**DURAFLEX DURAGLIDE ECONOMIC INTERIOR BRUSH SEALS FOR DOOR & WINDOW FRAMES**

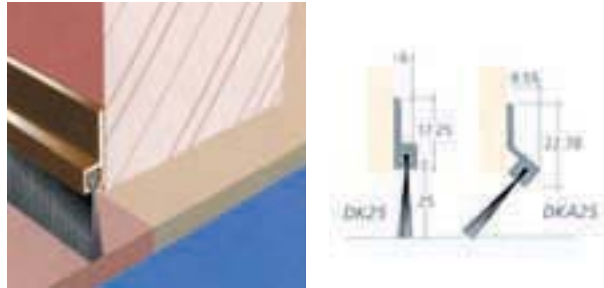

H0852501 - 915mm Silver  
H0852502 - 915mm Brass  
H0852511 - 2100mm Silver  
H0852512 - 2100mm Brass

**DURAFLEX BEADSEAL, IKP20 & COVERSEAL TOUGH FLEXIBLE SEALS FOR MOST WINDOWS & DOORS ESPECIALLY SLIDING SASH WINDOWS**

**BS15      IKP20      CS20**

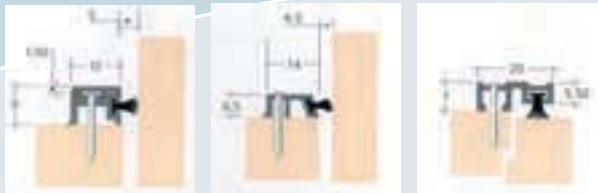

H0855731 - BS15 2100mm White  
H0855732 - IKP20 2100mm White  
H0855733 - CS20 2100mm White

**DURAFLEX CSS20 CLIPSTRIP STYLISH & EFFICIENT WAY TO DRAUGHT PROOF WINDOWS & DOORS**



H0855734 - 2100mm White

**Draught Excluders**

**DURAFLEX ELLENFLEX 1  
SELF ADHESIVE FLEXIBLE FOAM SEAL  
FOR ALL DOORS & WINDOWS**



H085650 - 17.5 Metre White  
H0856511 - 15 Metre White

**DURAFLEX NP450 SELF ADHESIVE  
NYLON BRUSH PILE FOR HINGES  
DOORS & SASH WINDOWS**

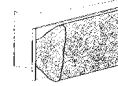

H0857501 - 5 Metre Grey

**DURAFLEX E STRIP  
SELF ADHESIVE SEAL**



H0855735 - 6 Metre White

**DURAFLEX P STRIP  
SELF ADHESIVE STRIP**



H0855736 - 6 Metre White

**DURAFLEX E LETTER BOX  
DRAUGHT SEAL**



H0858001 - Without Flap White  
H0858501 - With Internal Flap White

**PLAIN RUBBER DRAUGHT TUBING 5MM  
TUBE 60FT COIL**



H0851001 - White

**DURAFLEX FINPROTECT FINGER PROTECTION FOR DOORS PREVENTS  
SERIOUS INJURY TO FINGERS TRAPPED ON THE HINGE SIDE OF DOORS**



H0855741 - Single Broad Set White

H0855742 - Standard Set White

H0855743 - Swing Door Set White

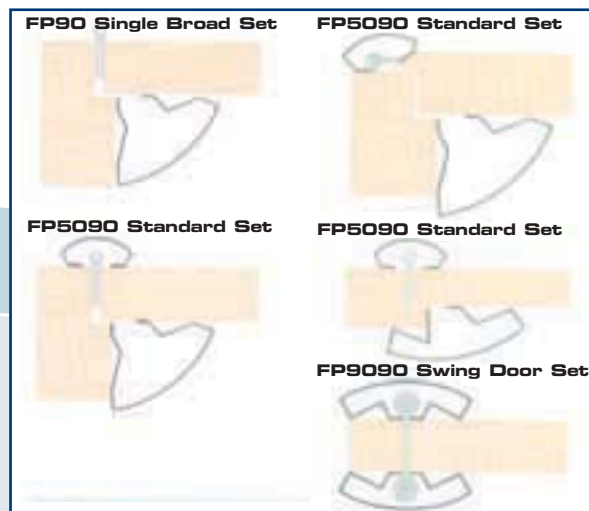

other finishes available to order



Draught Seals

## Adjustable Shelving

### SPUR STEEL-LOK HEAVY DUTY STEEL ADJUSTABLE WALL MOUNTED SHELVING



#### STEEL-LOK UPRIGHTS

<b>WHITE</b>		
H0760001 - 9011	430mm	
H0760011 - 9012	710mm	
H0760021 - 9013	1000mm	
H0760031 - 9014	1220mm	
H0760041 - 9016	1600mm	
H0760051 - 9018	1980mm	
H0760061 - 9020	2400mm	

<b>CHROME</b>		
H0760015 - 9012CH	710mm	
H0760025 - 9013CH	1000mm	
H0760035 - 9014CH	1220mm	
H0760045 - 9016CH	1600mm	



#### STEEL-LOK BRACKETS

<b>WHITE</b>		
H0760501 - 9001	120mm	
H0760511 - 9002	170mm	
H0760521 - 9002B	220mm	
H0760531 - 9003	270mm	
H0760541 - 9005	320mm	
H0760551 - 9004	360mm	
H0760561 - 9004B	360mm	
H0760571 - 9006	470mm	
H0760581 - 9021	610mm	

<b>CHROME</b>		
H0760505 - 9002CH	170mm	
H0760525 - 9002BCH	220mm	
H0760535 - 9003CH	270mm	
H0760545 - 9005CH	320mm	
H0760565 - 9004BCH	365mm	

<b>WHITE Heavy Duty</b>		
H0762001 - 9004BR	360mm	
H0762011 - 9006R	470mm	
H0762021 - 9021R	610mm	



#### SPUR SHELF STIFFENER WHITE



H0765001 - 9294 1 metre

#### SPUR STEEL SHELVES

<b>WHITE</b>		
H0764501 - 9312C	1 metre x 170mm	
H0764511 - 9313C	1 metre x 220mm	
H0764521 - 9414C	1 metre x 270mm	
H0764531 - 9315C	1 metre x 320mm	
H0764541 - 9316C	1 metre x 360mm	
H0764551 - 9317C	1 metre x 470mm	
H0764561 - 9526	1 metre x 610mm	



**Adjustable Shelving**

**SPUR SHELF ENDS FOR WOODEN SHELVES  
WHITE**



- H0762501 - 9071L 150 x 150 L/H
- H0762511 - 9071R 150 x 150 R/H
- H0762521 - 9072L 200 x 150 L/H
- H0762531 - 9072R 200 x 150 R/H
- H0762541 - 9073L 250 x 150 L/H
- H0762551 - 9073R 250 x 150 R/H

**SPUR SPRING ROD BOOK  
SUPPORTS WHITE**



- H0764001 - 9085 150mm Pair
- H0764011 - 9088 200mm Pair
- H0764021 - 9087 250mm Pair

**SPUR SQUARE BOOK END WHITE**



- H0763001 - 9082

**SPUR ROD BOOK SUPPORT GILT ANNOXIDISED**



- H0763501 - 9084A

**SPUR MULTI PURPOSE JOINT CADMIUM  
PLATED**



- H0765501 - 9032

**SPUR GLASS SHELF RETAINER SUITABLE FOR  
6MM GLASS SHELVES**



- H0766001 - 9326

**SPUR TARQUET CLIP FOR SECURING INFILL  
PANELS BETWEEN UPRIGHTS**



- H0766501 - 9069

**SPUR CABINET BRACKETS TO LOCATE &  
SUPPORT CABINETS ONTO UPRIGHTS  
CADMIUM PLATED**



- H0767001 - 9076L 25 x 76mm L/H
- H0767011 - 9076R 25 x 76mm R/H

Adjustable Shelving



**Shelf Brackets**

**STRONG REINFORCED**



- 150 x 125mm
- H0770011 - Bright Zinc Plated
- 200 x 150mm
- H0770012 - Bright Zinc Plated
- H0770022 - White
- 250 x 200mm
- H0770031 - Bright Zinc Plated
- H0770032 - White

**STRONGBEAM MITRED**



- H0770501 - 200 x 200 White
- H0770511 - 250 x 250 White
- H0770521 - 300 x 300 White
- H0770531 - 350 x 350 White

**STEEL SHELF BRACKET**



- H0773501 - 100 x 75mm Grey
- H0773511 - 125 x 100mm Grey
- H0773521 - 150 x 125mm Grey
- H0773531 - 200 x 150mm Grey
- H0773541 - 225 x 175mm Grey
- H0773551 - 255 x 205mm Grey
- H0773561 - 305 x 255mm Grey
- H0773571 - 355 x 305mm Grey

**ARCH BRACKET**



- 150 x 150mm
- H0771401 - Black
- H0771411 - Gloss Aluminium
- 200 x 200mm
- H0771402 - Black
- H0771412 - Gloss Aluminium

**CELTIC STEP BRACKET**



- 150 x 150mm
- H0771501 - Black
- H0771511 - Gloss Aluminium
- 200 x 200mm
- H0771502 - Black
- H0771512 - Gloss Aluminium

**CELTIC SCROLL BRACKET**



- 150 x 150mm
- H0771601 - Antique Bronze
- H0771611 - Pewter
- 200 x 200mm
- H0771602 - Antique Bronze
- H0771612 - Pewter

**GALVANISED STEEL ANGLE BRACKET**



- H0774501 - 102 x 76mm
- H0774511 - 127 x 102mm
- H0774521 - 152 x 127mm
- H0774531 - 203 x 152mm
- H0774541 - 254 x 152mm

**STAR BRACKET FOR WOODEN & GLASS SHELVES**



- Suitable for 200mm Shelves
- H0771001 - Silver
- H0771002 - Chrome

**MILAN BRACKET FOR 6MM GLASS SHELVES**



- Also available to suit 18mm wooden shelves
- H0771101 - Gloss Aluminium

**Shelf Brackets**

**VENICE BRACKET FOR 6MM GLASS SHELVES**



Also available to suit 18mm wooden shelves

**H0771102 - Gloss Aluminium**

**ROME BRACKET FOR 6MM GLASS SHELVES**



Also available to suit 18mm wooden shelves

**H0771103 - Gloss Aluminium**

**COMET BRACKETS**



Small for Glass Shelves up to 200mm Wide & 10mm Thick

**H0771701 - Chrome**

Medium for Glass and Wooden Shelves up to 250mm Wide & 20mm Thick

**H0771702 - Chrome**

Large for Glass and Wooden Shelves up to 300mm Wide & 25mm Thick

**H0771703 - Chrome**

**SHELF SLOT BRACKET FOR 15MM BOARD**



**H0769001 - 600mm White**  
**H0769002 - 900mm White**  
**H0769003 - 1200mm White**  
**H0769004 - 1650mm White**

**SHELF SLOT BRACKET FOR 6MM GLASS**



**H0769011 - 400mm Silver**

**SHELF SLOT BRACKET FOR 6MM GLASS CORNER SHELF**



**H0769021 - 200 x 200mm Silver**

**SHELF GRIP BRACKET  
MINIMUM SHELF THICKNESS  
3MM**



Petite - For Shelves up to 200mm Wide & 10mm Thick  
**H0769511 - Pair White**

Standard - For Shelves up to 250mm Wide & 25mm Thick  
**H0769512 - Pair White**

Grande - For Shelves up to 300mm Wide & 28mm Thick  
**H0769513 - Pair White**

**ILLUSION SHELVES  
BRACKETLESS WOODEN  
SHELVES**



**H0771801 - 800x250x38mm Maple**  
**H0771802 - 800x200x25mm Maple**

Also Available in beech.

**SUSPENSION WIRE  
SUPPORTS  
FOR 6MM GLASS SHELVES**



**H0771805 - Chrome**

Shelving

FLUSH FITTING BOOKCASE STRIP



Length 1830mm  
Size 19 x 3mm  
Other Finishes Available To Order

- H0776001 - Zinc Plated
- H0776002 - Brown Bronzed
- H0776003 - Electro Brass
- H0776004 - SAA

SURFACE FITTING BOOKCASE STRIP

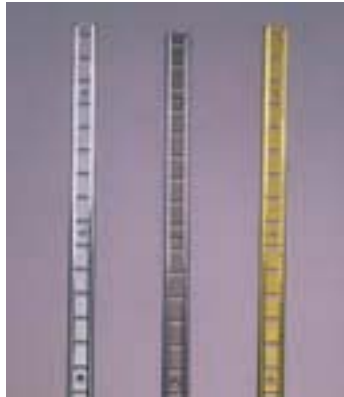

Length 1830mm  
Size 19 x 5mm  
Other Finishes Available To Order

- H0777001 - Zinc Plated
- H0777002 - Brown Bronzed
- H0777003 - Electro Brass
- H0777004 - SAA

BOOKCASE FITTINGS



Flat Studs (Packs of 10)  
H0776501 - Zinc Plated  
H0776502 - Brown Bronzed  
H0776503 - Electro Brass

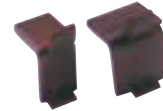

Extra Strong Studs (Packs of 10)  
H0776511 - Zinc Plated  
H0776512 - Brown Bronzed  
H0776513 - Electro Brass



Rubber Buffers (Packs of 10)  
H0776551 - Black

BANJO PATTERN FITTINGS



H0775501 - Brass Shelf Support  
H0775511 - Brass Shelf Studs

GLASS SHELVES



6MM GLASS SHELVES ROUNDED CORNERS



H0768001 - 400 x 100mm Clear  
H0768002 - 460 x 150mm Clear

6MM GLASS SHELVES RADIUS CORNER



H0768003 - 280mm Clear  
H0768004 - 230mm Clear

15MM MELAMINE BOARD COLOUR WHITE LENGTH 2440MM



- Z4033509 - 152mm
- Z4033510 - 229mm
- Z4033511 - 305mm
- Z4033512 - 381mm
- Z4033513 - 457mm
- Z4033514 - 533mm
- Z4033515 - 610mm
- Z4033517 - 762mm

IRON ON EDGING 19MM

H9945257 - White 2.5 Mtr Coil

6MM RECTANGULAR GLASS SHELVES

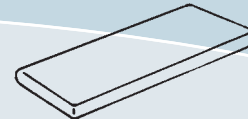

H0768005 - 800 x 250mm Clear  
H0768006 - 600 x 200mm Clear

6MM CURVED GLASS SHELVES



H0768007 - 600 x 200/150mm Clear  
H0768008 - 800 x 250/150mm Clear

**Television & Audio Brackets**



**6085BL VIDEO BRACKETS TO SUIT VIDEO UP TO 470MM**

H0771901 - Black

**6081BL STANDARD TV BRACKET TO SUIT TV 300 X 410MM, SCREEN 14" - 16"**

H0771902 - Black

**6083 MICROWAVE BRACKET TO SUIT MICROWAVE 400 X 520MM**

H0771905 - White

**6087BL PREMIER TV BRACKET TO SUIT TV 290 X 320M, SCREEN 14" - 18"**

H0771903 - Black

**6088BL PREMIER TV BRACKET TO SUIT TV 290 X 320M, SCREEN 18" - 24"**

H0771904 - Black



**Tool Hooks**



**SINGLE TOOL HOOKS    SINGLE TIDY HOOK    DOUBLE TOOL HOOKS**



H0775602 - 7531



H0775603 - 7532

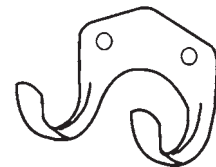

H0775601 - 7530

**LADDER BRACKET & PADLOCK**

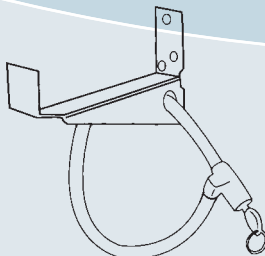

H0775604 - 7534

**HANGING BASKET BRACKET BLACK FINISH**



H0775611 - 254mm 7438    H0775613 - 280mm 7443  
H0775612 - 300mm 7439    H0775614 - 380mm 7444



**Dexion Shelving**



**PUNCHED STEEL STRAP 3 MTR LENGTH**



Z4020001 - Grey 38 x 2mm

**ANGLE 3 MTR LENGTH**

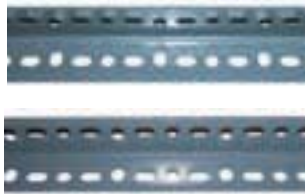

Dexion 140  
Z4020003 - 36x36x1.75mm Grey  
Dexion 160  
Z4020004 - 40x40x2mm Grey

**ANGLE LENGTH 3 MTR**



Dexion 225  
H4020005 - 62x41x2mm Grey  
Dexion 260  
H4020006 - 66x45x2.5mm Grey

**CORNER PLATES**



Z4020008 - 8mm Grey

**HEXAGON HEAD NUTS & BOLTS PACK OF 50**

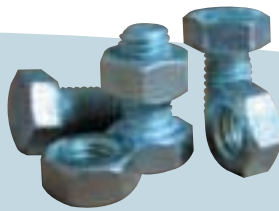

Z4020010 - 8mm

**METAL BASE PLATES**

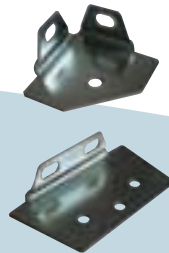

Z4020013 - Single Section  
Z4020014 - Double for T Section

**SPANNER SET AND PORTABLE CUTTER MK V**



Z4020021 - Spanner Set  
Z4020031 - Portable Cutter

**FIXED CASTORS**



Z4020041 - 2 1/2" Diameter  
Z4020042 - 4" Diameter

**SWIVEL CASTORS**



Z4020043 - 2 1/2" Diameter  
Z4020044 - 4" Diameter

**ADJUSTABLE SHELF CLIPS**



Z4020061

**STANDARD DUTY SHELVES**



H4020051 - 36x12" Grey  
H4020052 - 36x15" Grey  
H4020053 - 36x18" Grey  
H4020054 - 36x24" Grey

Shelving



**Screws**

**COUNTERSUNK  
SLOTTED WOODSCREW**

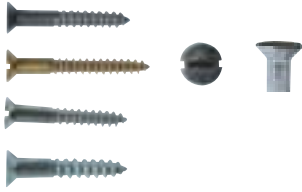

Available in various sizes in the following finishes

- Bright Steel - H1200001 - H1205014
- BZP - H1206001 - H1209509
- Brass - H1213001 - H1217010
- C.P. - H1217501 - H1220002

**ROUND HEAD  
SLOTTED WOODSCREWS**

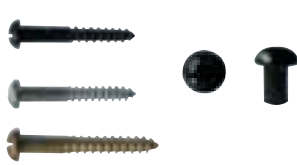

Available in various sizes in the following finishes

- Black Japanned - H1222501 - H1225505
- BZP - H1225516 - H1225549
- Brass - H1226001 - H1228505
- C.P. - H1229001 - H1230502

**RAISED HEAD SLOTTED  
WOODSCREWS**

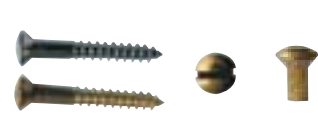

Available in various sizes in the following finishes

- Brass - H1236001 - H1238503
- C.P. - H1240001 - H1242502

**COUNTERSUNK POZIDRIV  
SCREWS**

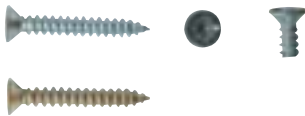

Available in various sizes in the following finishes

- BZP - H1244001 - H1246311
- Brassed - H1246512 - H1246561

**CLUTCH HEAD SCREWS**



Available in various sizes in the following finishes

- BZP - H1250001 - H1250031

**STEEL DOWEL SCREWS  
PACKS OF FOUR**



- H9945279 - 25 x 6 Gauge
- H9945280 - 25 x 8 Gauge
- H9945281 - 32 x 8 Gauge

**COUNTERSUNK SELF TAPPING  
SCREWS**

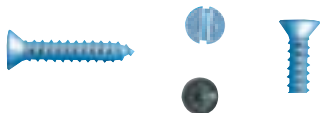

Available in various sizes in the following finishes

- BZP Slotted - H1247002 - H1247045
- BZP Pozidriv - H1248003 - H1248043

**PAN HEAD SELF TAPPING SCREWS**



Available in various sizes in the following finishes

- BZP Slotted - H1247504 - H1247555

**C.P. DOMEHEAD  
BRASS MIRROR SCREWS**



Available in various sizes  
Brass - H1251001 - H1251014

**DRYWALL SCREWS**



Available in various sizes

- Black Phosphated - H9941049 - H9941055

**COACH SCREWS**

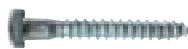

Available in various sizes

- BZP - Z1800001 - Z1800098

**HEXAGON SET SCREWS**



Available in various sizes i

- BZP - Z1806501 - Z1808021

Fixing Devices

**Nails and Bolts**

**COACH BOLTS AND NUTS**



Available in various sizes

BZP - Z9000145 - Z9000213

**HEX HEAD BOLTS AND NUTS**



Available in various sizes

Black - Z9000226 - Z9000245

**FOUNDATION BOLTS AND NUTS**



Available in various sizes

Self Colour - Z1806001 - Z1806043

**ROUND WIRE NAILS  
PLAIN HEAD**



Available in various sizes in the following finishes

Bright Steel - Z1600001 - Z1600083  
Galvanised - Z1600501 - Z1600583

**ROUND WIRE NAILS LOST HEAD**



Available in various sizes in the following finishes

Bright Steel - Z1601003 - Z1601033  
Sheradised - Z1601501 - Z1601533

**OVAL WIRE NAILS  
ORDINARY HEAD**



Available in various sizes

Bright Steel - Z1603001 - Z1603073

**OVAL WIRE NAILS  
LOST HEAD**



Available in various sizes

Bright Steel - Z1603523 - Z1603553

**JAGGED PLASTER  
BOARD NAILS**



Available in various sizes

Galvanised - Z1605501 - Z1605513

**CUT CLASP NAILS**



Available in various sizes i

Self Colour - Z1606001 - Z1606023

**FLOOR BRADS**



Available in various sizes

Self Colour - Z1606501 - Z1606523

**STAPLES**



Available in various sizes i

Galvanised - Z1607001 - Z1607053

**CUT TACKS**



Available in various sizes i

Blued - Z1607501 - Z1607533

**PANEL PINS**



Available in various sizes in the following finishes

Bright Steel - Z1608001 - Z1608063  
Sheradised - Z1608501 - Z1608543

## Fischer Fixings

### PLASTIC WALLPLUGS



	Screw Size
H1005001 - S4	2-3mm
H1005011 - S5	3-4mm
H1005021 - S6	4-5mm
H1005031 - S7	4-5.5mm
H1005041 - S8	4.5-6mm
H1005051 - S10	6-8mm
H1005061 - S12	8-10mm
H1005071 - S14	10-12mm
H1005081 - S16	12mm
H1005091 - S20	14-16mm

### HIGH PERFORMANCE NYLON WALLPLUGS



	Screw Size
H1005101 SX6	4-5mm
H1005102 SX8	4.5-6mm
H1005103 SX10	6-8mm
H1005104 SX12	8-10mm

### UNIVERSAL FIXING WALLPLUG



	Screw Size
H1005111 UX6R	4-5
H1005112 UX8R	4.5-6
H1005113 UX10R	6-8

### NYLON FRAME-FIXINGS WITH COUNTERSUNK CROSS DRIVE SCREW



	Size	Usable length
H1005121 TL Framefix	8x80	
H1005122 TL Framefix	8x100	
H1005123 TL Framefix	8x120	
H1005124 TL Framefix	8x135	
H1005125 TL Framefix	10x80	
H1005126 TL Framefix	10x100	
H1005127 TL Framefix	10x115	
H1005128 TL Framefix	10x135	
H1005129 TL Framefix	10x160	

### NYLON HAMMERFIX WITH Z.P. DRIVE SCREW

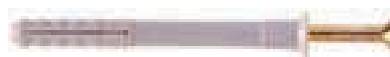

	Size	Usable Length
H1005999 N5x40		15mm
H1006000 N6x40		10mm
H1006001 N6x60		30mm
H1006011 N6x80		50mm
H1006031 N8x80		40mm
H1006041 N8x100		60mm
H1006051 N8x120		80mm

### PVCU NYLON WINDOW FRAME FIXING



	Size
H1005131 TL	8x100
H1005132 TL	8x120
H1005133 TL	8x140
H1005134 TL	10x75
H1005135 TL	10x100
H1005136 TL	10x120
H1005137 TL	10x140

# Fixing Devices

### METAL CAVITY FIXINGS

	Size	Fixture Thickness
H1005141 HM4x46S		23mm
H1005142 HM4x59S		16mm
H1005143 HM5x37S		19mm
H1005144 HM6x52S		24mm
H1005145 HM6x52S		24mm
H1010501 HMZ1		Professional Tool



### TOGGLE CAVITY FIXINGS WITH SCREWS

	Screw Size
H1005151 KT3x50S	M3x50mm
H1005152 KT5x50S	M5x50mm
H1005153 KT6x75S	M6x75mm



### SELF DRILLING PLASTERBOARD FIXINGS

H1015161	PDM100
H1015162	FD

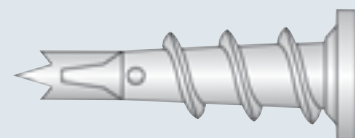

## Fischer Fixings

### THROUGHBOLT STEEL ANCHORS

#### FBN & TL



For use when fixing into concrete Available in B.Z.P., stainless steel and hot dipped, galvanised finishes.

#### FA2



Available to order for use on critical fixings and when fixing into cracked concrete. Available in B.Z.P., stainless steel and hot dipped galvanised finishes.

#### FH



A high performance throughout which can be used with cracked concrete. Available with 4 head types and supplied in B.Z.P., stainless steel and hot dipped galvanised finishes.

### FBN THROUGHBOLTS B.Z.P.

		Usable Length
H1005171	FBN6x40	5mm
H1005172	FBN6x55	10mm
H1005173	FBN6x75	30mm
H1005174	FBN8x60	5mm
H1005175	FBN8x75	10mm
H1005176	FBN8x95	30mm
H1005177	FBN10x70	5mm
H1005178	FBN10x90	15mm
H1005179	FBN10x125	50mm
H1005180	FBN12x85	5mm
H1005181	FBN12x115	15mm
H1005182	FBN12x130	30mm
H1005183	FBN12x145	45mm
H1005184	FBN16x110	10mm
H1005185	FBN16x145	25mm
H1005186	FBN16x170	50mm
H1005187	FBN16x220	100mm
H1005188	FBN20x120	10mm
H1005189	FBN20x165	20mm
H1005190	FBN20x205	60mm

### TL THROUGHBOLTS STAINLESS STEEL

		Usable Length
H1005201	TL6x40 A4	5mm
H1005202	TL6x55 A4	15mm
H1005203	TL6x85 A4	40mm
H1005204	TL8x50 A4	6mm
H1005205	TL8x75 A4	30mm
H1005206	TL8x95 A4	40mm
H1005207	TL10x60 A4	8mm
H1005208	TL10x75 A4	15mm
H1005209	TL10x90 A4	25mm
H1005210	TL10x120 A4	55mm
H1005211	TL12x80 A4	10mm
H1005212	TL12x95 A4	20mm
H1005213	TL12x110 A4	40mm
H1005214	TL12x130 A4	60mm
H1005215	TL16x90 A4	7mm
H1005216	TL16x125 A4	30mm
H1005217	TL16x145 A4	50mm
H1005218	TL16x180 A4	65mm
H1005219	TL20x120 A4	15mm
H1005220	TL20x160 A4	50mm
H1005221	TL20x220 A4	110mm

## Fischer Fixings

### WALL BOLT SHIELD ANCHORS

Suitable for Solid Brick, Concrete & Stone  
Loose Bolt Type



		Size
H1005231	FWB6/10L	M6x55mm
H1005232	FWB6/25L	M6x70mm
H1005233	FWB6/40L	M6x85mm
H1005234	FWB8/10L	M8x65mm
H1005235	FWB8/25L	M8x80mm
H1005236	FWB8/40L	M8x95mm
H1005237	FWB10/10L	M10x75mm
H1005238	FWB10/25L	M10x90mm
H1005239	FWB10/50L	M10x115mm
H1005240	FWB10/75L	M10x140mm
H1005241	FWB12/10L	M12x90mm
H1005242	FWB12/25L	M12x105mm
H1005243	FWB12/40L	M12x120mm
H1005244	FWB12/60L	M12x140mm
H1005245	FWB16/15L	M16x135mm
H1005246	FWB16/30L	M16x150mm
H1005247	FWB16/60L	M16x180mm

### WALL BOLT SHIELD ANCHORS

suitable for solid brick concrete & stone  
Projecting Bolt Type



		Size
H1005251	FWB6/10P	M6x65mm
H1005252	FWB6/25P	M6x80mm
H1005253	FWB6/60P	M6x115mm
H1005254	FWB8/10P	M8x75mm
H1005255	FWB8/25P	M8x90mm
H1005256	FWB8/60P	M8x125mm
H1005257	FWB10/15P	M10x90mm
H1005258	FWB10/30P	M10x105mm
H1005259	FWB10/60P	M10x135mm
H1005260	FWB12/15P	M12x110mm
H1005261	FWB12/30P	M12x125mm
H1005262	FWB12/75P	M12x170mm
H1005263	FWB16/15P	M16x150mm
H1005264	FWB16/35P	M16x170mm
H1005265	FWB20/15P	M20x170mm

### WALL BOLTS SHIELDS ONLY



H1005271	TL M6
H1005272	TL M8
H1005273	TL M10
H1005274	TL M12

### SLEEVE ANCHORS

Suitable for concrete, stone, solid brick  
No fines concrete and breeze block  
Loose Bolt Type



		Size
H1005281	FSA 12/10/81S	M 12x81mm
H1005282	FSA 12/25/96S	M12x96mm

### SLEEVE ANCHORS

Suitable for concrete, stone  
Solid brick, no fines concrete & breeze block.  
Projecting Bolt Type



		Size
H1005291	FSA 6/8/38	M6x38mm
H1005292	FSA 8/8/42	M8x42mm
H1005293	FSA 8/30/66	M8x66mm
H1005294	FSA 10/10/48	M10x48mm
H1005295	FSA 10/35/75	M10x75mm
H1005296	FSA 10/60/100	M10x100mm
H1005297	FSA 12/12/58	M12x58mm
H1005298	FSA 12/20/70	M12x70mm
H1005299	FSA 12/50/100	M12x100mm
H1005300	FSA 16/12/64	M16x64mm

### DROP IN ANCHORS

For fixing into concrete & stone



		Size
H1005401	TLM6	8mmx25mm
H1005402	TLM8	10mmx30mm
H1005403	TLM10	12mmx40mm
H1005404	TLM12	15mmx50mm
H1005405	TLM16	20mmx65mm
H1005406	TLM20	25mmx80mm



## Fischer Fixings

### RESIN CAPSULE ANCHORS

For high performance anchorages in concrete and stone  
Styrene Free Low Odour



H1007701	RM8	For use with	8mm Studs & Sockets
H1007702	RM10		10mm Studs & Sockets
H1007703	RM12		12mm Studs & Sockets
H1007704	RM16		16mm Studs & Sockets
H1007705	RM20		20mm Studs & Sockets

### POLYESTER RESIN CARTRIDGE SYSTEMS

For high performance fixings into concrete, stone, solid brick, breeze block and hollow pots/blocks.



H1007801	FISP380C	Styrene Free Resin 380mm
H1007802	FISP	Resin gun for F1SP380C
H1007803	FIP300SF	Styrene Free Resin 300mm
H1007804	KPM2	Heavy Duty Resin Gun suitable for F1P300SF

n.b. Vinylester Systems Available for Critical Applications

### RESIN ANCHOR STUDS



		Size	
H1007901	TL8x110	M8x110mm	
H1007902	TL10x130	M10x130mm	
H1007903	TL12x160	M12x160mm	
H1007904	TL16x190	M16x190mm	
H1007905	TL20x260	M20x260mm	

### STAINLESS STEEL RESIN SOCKETS A2



		Size	
H1017911	TLM8 IA2	8mm	
H1017912	TLM10 IA2	10mm	
H1017913	TLM12 IA2	12mm	
H1017914	TLM16 IA2	16mm	

### B.Z.P. RESIN SOCKETS



		Size	
H1007921	TL M8 I	8mm	
H1007922	TL M10 I	10mm	
H1007923	TL M12 I	12mm	
H1007924	TL M16 I	16mm	

**Fixings Devices**

**PLASTIC COVER CAPS**

100 Per Pack



H9945581 - White  
H9945582 - Brown  
H9945583 - Grey  
H9945584 - Magnolia

**CROSS HEAD CAPS**

100 Per Pack



H9945585 - White  
H9945586 - Black  
H9945588 - Brown  
H9945589 - Grey  
H9945587 - Magnolia

**SCREW CUP WASHERS**

100 Per Pack



6 Gauge  
H9945575 - Brass  
H9945578 - N.P.  
8 Gauge  
H9945576 - Brass  
H9945579 - N.P.  
10 Gauge  
H9945577 - Brass  
H9945580 - N.P.

**BRASS SCREW SOCKETS**

10 Per Pack



H1002011 - 6 Gauge  
H1002031 - 8 Gauge  
H1002041 - 10 Gauge

**SHOULDERED SQUARE HOOK**

5 Per Pack



H9945213 - 19mm Brass  
H9945223 - 32mm Brass  
H9945224 - 25mm White PVC  
H9945225 - 32mm White PVC

**SHOULDERED CUP HOOK**

5 Per Pack



H9945218 - 19mm BZP  
H9945294 - 25mm BZP  
H9945220 - 32mm BZP  
H9945230 - 38mm BZP

**SHOULDERED CUP HOOK**

5 Per Pack



H9945214 - 19mm Brass  
H9945215 - 25mm Brass  
H9945216 - 32mm Brass  
H9945217 - 38mm Brass

**STEEL SCREW HOOKS**   **STEEL SCREW EYES**

Zinc Plated



H9945184 - Large Singles  
H9945183 - Standard Pack of 2

Zinc Plated



H9945182 - Standard Pack of 2  
H9945181 - Medium Pack of 2  
H9945180 - Small Pack of 2

**SINGLE PIN PICTURE HOOKS**

4 Per Pack



H9945256 - Electro Brass

**DOUBLE PIN PICTURE HOOKS**

2 Per Pack



H9945258 - Electro Brass

**MOULDING HOOKS**

Zinc Plated

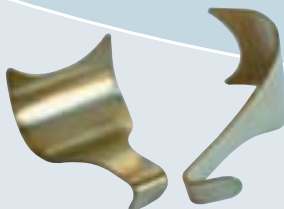

H9945203 - Brass

**PICTURE WIRE**

Zinc Plated



H9945099 - Size 1 x 3.5 mtr

**GLASS OR MIRROR PLATES**



H0614001 - 25mm Brass  
H0614011 - 38mm Brass  
H0614021 - 51mm Brass

**SLOTTED GLASS OR MIRROR PLATES**



H0614501 - 32mm Brass  
H0614511 - 38mm Brass  
H0614521 - 51mm Brass

**Fixing Devices**

**HALF BLOCKS**



H9945025 - White Pack of 4

**CORNER JOINTS**



H9945040 - White Pack of 4

**FLUSH MOUNTS**



H0662001 - 44 x 38mm (Per Pair)

**STRAIGHT REPAIR PLATES  
BZP STEEL**



H0660001 - 76mm  
H0660011 - 102mm  
H0660021 - 127mm  
H0660031 - 152mm

**CORNER REPAIR PLATES  
BZP STEEL**



H0660501 - 51mm  
H0660511 - 76mm  
H0660521 - 102mm  
H0660531 - 127mm  
H0660541 - 152mm

**TEE SHAPE REPAIR PLATE  
BZP STEEL**



H0661001 - 76mm  
H0661011 - 102mm

**CORNER BRACE  
BZP STEEL**

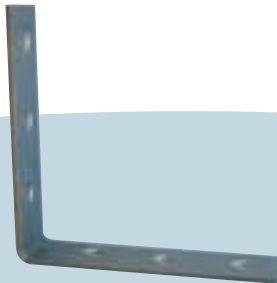

H0661501 - 25mm  
H0661511 - 38mm  
H0661521 - 51mm  
H0661531 - 76mm  
H0661541 - 102mm  
H0661551 - 127mm  
H0661561 - 152mm

**CORNER CLIP  
JAPANNED**



H0662501 - 38 x 51 x 51mm  
H0662511 - 38 x 64 x 64mm

**SLOTTED TABLE PLATE  
BRIGHT STEEL**



H0663501 - VERTICAL SLOT

**SLOTTED TABLE PLATE BRIGHT  
STEEL**



H0663501 - 45 x 32mm  
Horizontal Slot

**TABLE STRETCHER PLATE  
BRIGHT STEEL**



H0664001 - 38mm

**CABLE TIES**



H9945284 - 100mm x 2.5  
H9945285 - 150mm x 3.5  
H9945286 - 200mm x 4.6  
H9945287 - 270mm x 4.8

**Castors**

**41MM FLEXELLO  
FURNITURE CASTOR**



H0840001 - Peg Fixed  
H0840002 - Plate Fixed

**40MM SHEPHERD CASTOR  
No16 LIGHT FURNITURE**



H0841001 - Socket fitting

**64MM SHEPHERD CASTOR  
No54**



H0843001 - ScREW fixing  
H0843001 - As above with polytyre  
antistatic wheel

**SHEPHERD MINICASTOR  
No45 ALL METAL**



H0841501 - 51mm Diameter Wheel  
27mm Diameter Plate  
H0841511 - Sizes as above with  
polytyre antistatic  
wheel

**SHEPHERD MINICASTOR  
No46 ALL METAL**



H0842001 - 51mm Diameter Wheel  
32 x 10mm Socket  
H0842011 - Sizes as above with  
polytyre antistatic  
wheel

**SHEPHERD CASTOR  
No51**



H0842501 - 64mm Diameter Wheel  
38 x 38mm Plate  
H0842511 - Sizes as above with  
polytyre antistatic  
wheel

**FLEXELLO INDUSTRIAL CASTORS  
NYLON WHEEL SQUARE PLATE  
FITTING**



H0843501 - 41mm  
H0843502 - 41mm With Brake  
H0843511 - 51mm  
H0843512 - 51mm With Brake  
H0843521 - 64mm  
H0843522 - 64mm With Brake  
H0843531 - 76mm  
H0843532 - 76mm With Brake  
H0843541 - 102mm  
H0843542 - 102mm With Brake

**FLEXELLO INDUSTRIAL CASTORS  
RUBBER WHEEL  
SQUARE PLATEFITTING**



H0843503 - 41mm  
H0843503 - 41mm With Brake  
H0843513 - 51mm  
H0843514 - 51mm With Brake  
H0843523 - 64mm  
H0843524 - 64mm With Brake  
H0843533 - 76mm  
H0843534 - 76mm With Brake  
H0843543 - 102mm  
H0843544 - 102mm With Brake

Miscellaneous

**Notice Boards**

Dry wipe boards, magnetic and pin boards can be ordered in various sizes. Please ask for further details



**Barrier Systems**

Barrier systems are available with either corded ropes or retractable webbing

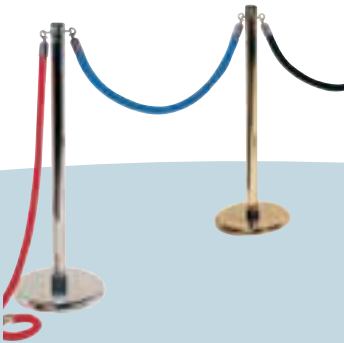

**BIRD BAN ANTI PERCHING SPIKES**

A flexible and durable system for preventing pigeons from landing. An effective non harmful deterrent for birds up to pigeon size. Bird ban can be screw fixed or attached using exterior quality silicone adhesive/sealant.



Size:  
Length 327m  
Spikes 112mm length

H0619001 - 2mtr pack  
Other pack sizes available to order



## Matwell Frames and Matting

Matwell Frames made to order in a choice of finishes and sizes which can be combined with a variety of matting materials.

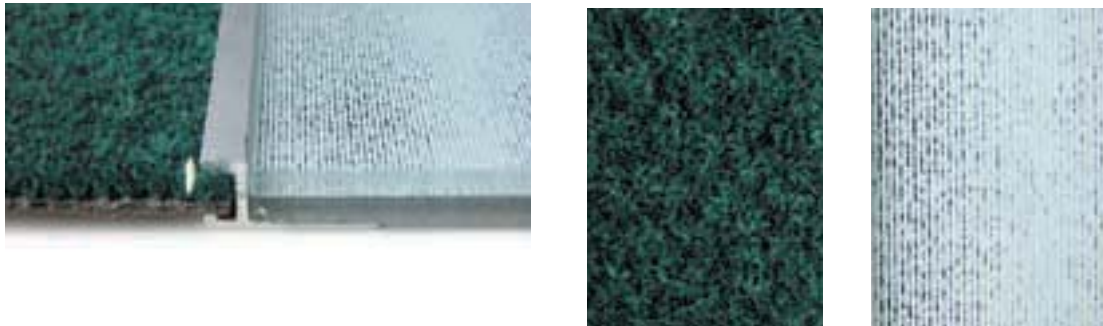

SIZE	ALUMINIUM	BRASS	STAINLESS STEEL
27 x 20 x 6mm (To take 17mm Mat)	•		
27 x 13 x 6mm (To take 12mm Mat)	•		
25 x 25 x 3mm	•	•	•
25 x 25 x 6mm	•	•	•
32 x 32 x 6mm	•	•	•
50 x 50 x 6mm	•	•	•
30 x 30 x 6mm			•

MOST FRAMES CAN BE CURVED TO A RADIUS

## Matwell Frames and Matting

### PVC BACKED COIR

- 17mm - Natural and 11 colours
- 14mm - Natural and 11 colours
- 20mm - Natural and 11 colours
- 23mm - Natural and 11 colours
- 30mm - Natural and 11 colours

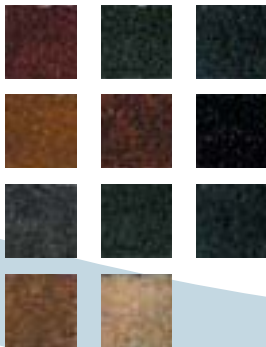

- WOVEN COIR
- COIR/JUTE CONSTRUCTION
- VC3-1.25" CREEL
- VC4-1" CREEL



### CORAL CLASSIC 9MM THICK

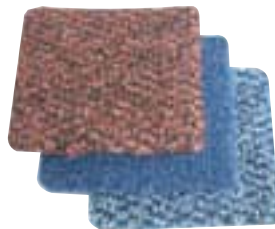

### DUST CONTROL MATTING

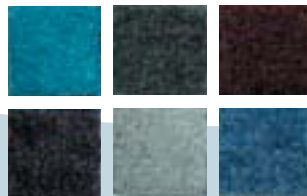

### INGENIUS 10MM & 15MM THICK

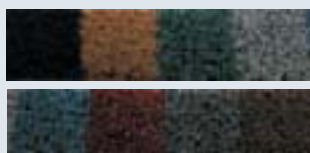

### CORAL BRUSH 9MM THICK



### POLY-RIB 9MM THICK



### LISTRE TWIST 8MM THICK



### RAINCHECK



Also available - 100% Coir, Fluted & Ribbed Rubber, Nomad Aqua, Winchester Elite, Zenprotect Super and Engineered Aluminium Mats.

Miscellaneous

**Water Butts and Dustbins**

**WATER BUTT  
SUPPLIED WITH DRAW  
OFF TAP AND LID**



- Z4032521 - 114 Litres Green
- Z4032522 - 170 Litres Green
- Z4032523 - 227 Litres Green
- Z4032524 - Draw off tap Replacement

**TYPE D DUSTBINS HEAVY  
DUTY POLYTHENE  
BIN AND LID**



- Z4032531 - 107 Litre 774 x 480 Black
- Z4032532 - 94 Litre 668 x 480 Black
- Z4032533 - 80 Litre 625 x 465 Black

**PARALLEL  
DUST BIN GALVANISED  
WITH METAL LID**



- Z4032541 - 760 x 455mm
- Z4032542 - 610 x 455mm
- Z4032543 - 510 x 405mm

Apart From our Stock Range of Bins as Shown Above We Can Also Supply a Wide Variety of Waste Receptacles, for Commercial or Domestic Use, as Well as Grit or Salt Bins. For Further Details about the Range Available Please Contact our Sales Office.

**CHARTER RANGE**



**CHARTER RANGE**



**WHEELY BINS**



**ROUNDOABOUT WASTE BINS**



**GRIT BINS**



**SATELLITE  
POST OR WALL MOUNTED**



Miscellaneous

## Capital Locker Range

A superb range of steel lockers available in a variety of sizes and colours giving security, versatility and value for money. Supplied to Order We Will Be Pleased to Quote for Your Requirements Upon Request.

### CAPITAL LOCKERS



Single Door Locker Two Door Locker Three Door Locker Four Door Locker Six Door Locker Slimline Locker

### CAPITAL LOCKERS



Divided Locker



New handle, with self adhesive numbers as standard



New handle, with colour coded number insert available at extra cost



New top vent detail

### QUARTO & SIXTO LOCKERS



Miscellaneous

**Tools**

WE SHOW HERE A SMALL SELECTION OF THE VAST SELECTION OF TOOLS AND SAFETY EQUIPMENT AVAILABLE EITHER FROM STOCK OR TO ORDER.

TO SEE THE FULL RANGE THAT IS AVAILABLE PLEASE ASK FOR YOUR COPY OF THE N&C TOOLS CATALOGUE.

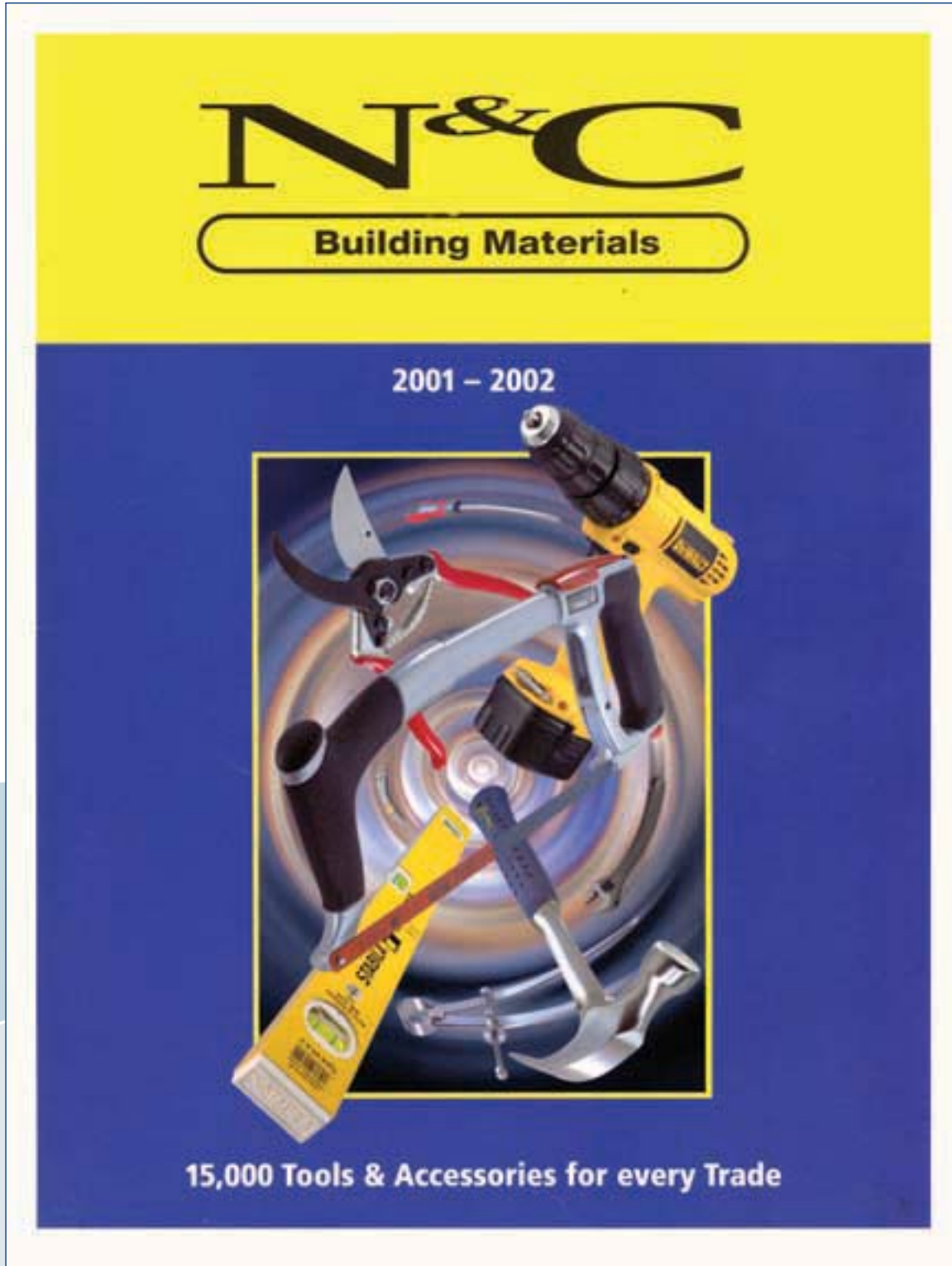

MOST OF THE ITEMS SHOWN IN THIS EXTENSIVE CATALOGUE IF NOT STOCKED CAN BE OBTAINED WITHIN A FEW DAYS

## Tools

### DYNAGRIP CHISELS



Available in sizes from 6mm to 32mm

H9923269 to H9923276

### BRICK BOLSTER



H9939080

### CHISELS



H9939081 - Electricians Bolster  
H9939085 - Plugging Chisel  
H9939108 - To H9939112  
Cold Chisels

### STANLEY CLAW HAMMER HICKORY HANDLE



H9923003 - 1602

### STANLEY STEEL CLAW HAMMER



H1048511

### CLUB HAMMER



H9999798 - 2 1/2lb  
H9999799 - 4lb

### STANLEY FIXED BLADE TRIMMING KNIFE



H9923058

### STANLEY TITAN RETRACTABLE BLADE KNIFE



H9923106

### STANLEY KNIFE BLADES



H9923081 - Pack Of Five

### COMBINATION PLIERS



H9999787

### LONG NOSE PLIERS



H9999790

### CUTTING PLIERS



H9939040



**Tools**

**STABILLA SPIRIT LEVELS**



H9999800 - 600mm  
H9999801 - 900mm  
H9999802 - 1200mm

**HANDSAWS**



H9999564

**HACKSAWS**



H9923284

**SLOTTED SCREWDRIVERS**



Available in a Range Of Sizes

H9923896 to H9923902

**PHILLIPS SCREWDRIVERS**



Available in a Range Of Sizes

H9923903 to H9923913

**STANLEY POWERLOCK RULES**



H9923076 - 5 mtr  
H9923077 - 8 mtr  
H9923078 - 10 mtr

**CONTRACTORS SHOVELS  
ALL STEEL**



H9999810

**CONTRACTORS FORK  
ALL STEEL**



H9999811 -

**CONTRACTORS BARROW**



H1141001  
3cu ft Solid Rubber Wheel  
H1141011  
4cu ft Solid Rubber Wheel  
H1141051 - 10 mtr  
3cu ft Pneumatic Wheel  
H1141061 - 10 mtr  
3cu ft Pneumatic Wheel

**TELL TALES FOR MEASURING  
MOVEMENT**



H1144010 - Standard  
H1144011 - Corner

**CHALK LINE**



H9923122  
H9924044

**REPLACEMENT LINE & CHALK**



H9924019 - Replacement Line 30mtr  
H1028533 - White Chalk

## Tools

### SAFETY HELMETS



H9923473 - White  
H9923474 - Yellow  
H9923475 - Blue  
H9923476 - Red

### SAFETY GOGGLES



H9923455

### SAFETY SPECTACLES



H9923458

### EAR PROTECTORS AND EAR PLUGS



H9923471 - Ear Protectors  
H9923472 - Ear Plugs Pack of 3

### CUP MASK



H9940501 - Each  
H9999584 - Pack of 3

### RESPIRATOR



H9999590

### CANADIAN RIGGER GLOVES



H1178001

### YELLOW GRIPPA GLOVES



H9923464-

### RED PVC KNIT GLOVES



H9923465-

### LATEX GLOVES



H9923943 Per Box of 100 Pairs

### POLYCOTTON COVERALLS



H9924233 - Navy Medium  
H9924234 - Navy Large  
H9924235 - Navy Extra Large

### DISPOSABLE COVERABLE



H9923477 - Large  
H9923478 - Extra Large

Ladders

The range of ladders, steps and loft ladders shown here are manufactured to B.S. Standards. To help identify the right product they are labelled as follows

- D.I.Y. Products
- ▲ Trade & Professional Products
- Heavy Duty & Industrial Products

If the product you require is not shown here please ring for details on ladders which will suit your requirements.

● **YOUNGMANS DIY100**  
**BS2037 CLASS 3**  
Aluminium Extension Ladder



- Non-slip twist proof rungs
- Strong box section aluminium stiles

Code	Section	Closed Height	Extended Height
H1194001	2	2.21m	3.66m
H1194002	2	2.79m	4.82m
H1194003	2	3.37m	5.98m
H1194004	2	3.95m	7.14m
H1194005	2	4.53m	8.30m
H1194006	3	2.21m	5.11m
H1194007	3	2.79m	6.85m
H1194008	3	3.37m	8.59m

▲ **YOUNGMANS TRADE**  
**200 BS EN131**  
Aluminium Extension Ladder



- High performance box section alloy stiles
- Non slip square rungs
- Unique wrap around top clips
- Extension lock for safe transportation

Code	Section	Closed Height	Extended Height
H1195001	2	2.50m	3.95m
H1195002	2	3.08m	5.11m
H1195003	2	3.66m	6.27m
H1195004	2	4.24m	7.43m
H1195005	2	4.82m	8.59m
H1195006	2	5.40m	9.75m
H1195007	3	2.50m	5.69m
H1195008	3	3.08m	7.43m
H1195009	3	3.66m	9.17m
H1195010	3	4.24m	10.68m

Also available in various sizes

▲ **YOUNGMANS TRADE 400**  
**BSEN131**  
Aluminium Extension Ladder



- Box section stiles
- Wall wheels
- Extra large slip resistant feet

■ **YOUNGMANS INDUSTRIAL 500 BS2037 CLASS 1**  
Heavy Duty Aluminium Ladder



- Box section stiles
- Wall wheels
- Extra large slip resistant feet

■ **YOUNGMANS STECALLOY 500 BS2037 CLASS 1**  
Heavy Duty Aluminium Ladder



- Heavy trade or industrial use
- Unique anti twist rung joints
- High spec alloy arrow shaped stiles and round rungs.

▲ **YOUNGMANS ROOF HOOK**



- Makes any ladder an effective roof ladder
- Maximum Load 150kg

H1196001

▲ **YOUNGMANS LADDER STAY**



- Makes working at height easier and safer
- Avoids damage to gutters, tiles and window frames

H1197001

## Ladders

### ● ATLAS STEPS BS2037 CLASS 3 Domestic Stepladder



- Lightweight
- Extra High Knee Rail
- Slip resistant treads

Code	Treads	Platform Height
H1190001	3	0.64m
H1190011	4	0.87m
H1190021	5	1.11m
H1190031	6	1.33m
H1190041	7	1.56m
H1190051	8	1.79m

### ■ BUILDERS STEPS BS2037 CLASS 1 Aluminium Stepladder



- Industrial Standard
- Large Non Slip Treads
- Broad Base

Code	Treads	Platform Height
H1198001	5	1.06m
H1198002	6	1.27m
H1198003	7	1.48m
H1198004	8	1.69m
H1198005	10	2.10m
H1198006	12	2.52m
H1198007	14	2.94m

### ● 3 WAY BS2037 CLASS 3 Combination Ladder



- Combines light weight and versatility
- Can be used as Double sided step ladder
- Extension Ladder
- Free standing stairwell stepladder

	Closed Height	Extended Height
H1188501	2.04m	2.90m

### ● SPACEMAKER BS7553 CLASS G 2 Section Aluminium Loft Ladder



- Fits loft openings as small as 457mm long x 406mm wide
- Wide flat non slip treads and rubber feet for safety
- Complete with all necessary fittings
- Easy to follow installation instructions
- Duty rating 100kg
- Max floor to ceiling height 2.60m

H1193001

### ● EASIWAY BS7553 CLASS G 3 Section Aluminium Loft Ladder



- Wide comfortable treads and handrail
- Pivot arm provides smooth gliding operation
- Easy to follow installation instructions
- Fits opening from 508mm x 432mm
- Duty rating 100kg
- Max floor to ceiling height 3m

H1192501

### ▲ PAKAWAY

Concertina Action Loft Ladder



- Requires no clearance behind loft hatch
- Complete with all fittings and instructions
- Duty rating 110kg
- All Models Fit a Minimum opening 360mm x 460mm

H1192001  
Maximum floor to ceiling height: 2.50m  
H1192011  
Maximum floor to ceiling height: 2.70m  
H1192021  
Maximum floor to ceiling height: 3.00m

Ladders

**Air Bricks**

**CAST IRON SQUARE HOLES**



- Z4000101 - 229x76mm Plain iron
- Z4000102 - 229x76mm Galvanised
- Z4000111 - 229x152mm Plain iron
- Z4000112 - 229x152mm Galvanised
- Z4000121 - 229x229mm Plain iron
- Z4000122 - 229x229mm Galvanised

**CAST IRON SCHOOL BOARD PATTERN**



- Z4000501 - 229x76mm Plain iron
- Z4000511 - 229x152mm Plain iron
- Z4000512 - 229x152mm Galvanised
- Z4000521 - 229x229mm Plain iron
- Z4000522 - 229x229mm Galvanised

**TERRA COTTA AIR BRICK**

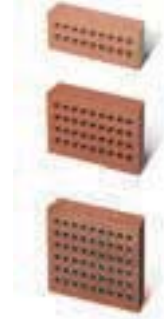

- Z4002001 - 229x76mm Red
- Z4002002 - 229x152mm Red
- Z4002003 - 229x229mm Red

**SNOWGUARD**



- Z4008001 - 2 mtr x 152mm
- Z4008002 - 2 mtr x 229mm

**SNOWGUARD BRACKETS FOR H.R. GUTTER**



- Z4008003 - For 152mm Snowguard
- Z4008004 - For 229mm Snowguard

**SNOWGUARD BRACKET FOR O.G. GUTTER**



- Z4008005 - Will Fit Both Sizes of Snowguard

**Chain Link Fencing**

**GALVANISED CHAIN LINK FENCING INCLUDING LINE WIRES**



25 metre Rolls

- Z4011501 - 900mm High
- Z4011502 - 1200mm High
- Z4011503 - 1400mm High
- Z4011504 - 1800mm High

**FITTINGS FOR CHAIN LINK FENCING ON CONCRETE POSTS**

25 metre Rolls

Each set consists of: Stretcher Bar, 2 Angle Deats, 2 Straining Eye Bolts, Nuts and Washers 2 Bolts and Nuts.

- Z4012501 - For 900mm Fencing
- Z4012502 - For 1200mm Fencing
- Z4012503 - For 1400mm Fencing
- Z4012504 - For 1800mm Fencing

**GREEN PLASTIC COATED CHAIN LINK FENCING INCLUDING LINE WIRES**



25 metre Rolls

- Z4012001 - 900mm High
- Z4012002 - 1200mm High
- Z4012003 - 1400mm High
- Z4012004 - 1800mm High



## Wire Fencing

### WIRE STRAINERS GALVANISED



Z4012505 - 120mm

### STRAINING EYE BOLTS WITH NUTS AND WASHERS

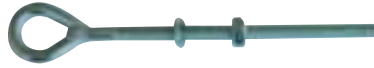

- Z4012531 - M6 x 150 Galvanised
- Z4012534 - M8 x 200mm Galvanised
- Z4012535 - M10 x 250mm Galvanised
- Z4012536 - M10 x 300mm Galvanised

### BARREL STRAINERS



- Z4012541 - 95mm x 20mm
- Z4012542 - 100mm x 23mm
- Z4012543 - 110mm x 27mm

### GALVANISED PLAIN FENCING WIRE 25 KG COILS



- Z4014001 - 162.75m x 5mm
- Z4014002 - 254.50m x 4mm
- Z4014003 - 410.25m x 3.15mm
- Z4014004 - 651.25m x 2.50mm
- Z4014005 - 1017.50m x 2mm
- Z4014006 - 1584m x 1.60mm

### GALVANISED PLAIN FENCING WIRE 10KG COILS



- Z4014011 - 164.10m x 3.15mm
- Z4014012 - 260.50m x 2.50mm
- Z4014013 - 407.25m x 2.00mm
- Z4014014 - 633.90m x 1.60mm

### GALVANISED PLAIN FENCING WIRE 0.50 KILO COILS



- Z4014021 - 20.35m x 2mm
- Z4014022 - 31.69m x 1.60mm
- Z4014023 - 51.93m x 1.25mm
- Z4014024 - 100.19m x 0.90mm

### GALVANISED WIRE NETTING 13MM MESH

- Z4008501 - 50mtr x 300mm
- Z4008503 - 50mtr x 600mm
- Z4008505 - 50mtr x 900mm
- Z4010002 - 25mtr x 900mm
- Z4010003 - 25mtr x 1200mm
- Z4010004 - 25mtr x 1800mm

### WIRE NETTING FASTENERS

- Box of 200
- Z4012511 - 16 x 10mm ZP

### BARBED WIRE GALVANISED



- Z4013501 - 200mtr coil
- Z4013502 - 15mtr coil

### ARRIS RAIL REPAIR BRACKET



- Z4013001 - 300mm Galvanised

### ANGLE IRON NETTING STAKES 38 x 38 x 3MM

- Z4012521 - Stakes 1200mm Long
- Z4012522 - Stakes 1500mm Long
- Z4012523 - Stakes 1800mm Long

**Chain And Fittings**

**STRAIGHT LINK CHAIN  
BLACK JAPANNED**

SOLD PER METRE

- Z4014501 - 3 x 21MM
- Z4014502 - 4 x 32MM
- Z4014503 - 5 x 35MM

**STRAIGHT LINK CHAIN  
GALVANISED**

SOLD PER METRE

- Z4014511 - 3 x 21MM
- Z4014512 - 4 x 32MM
- Z4014513 - 5 x 35MM

**SPIKED LINK CHAIN  
GALVANISED**

SOLD PER METRE

- Z4014522 - 6MM DIAMETER



**BRASS OVAL LINK CHAIN**

SOLD PER METRE

- H0615501 - 16mm Brass
- H0615502 - 16mm CP
- H0615511 - 19mm Brass
- H0615512 - 19mm CP

**BRASS CHANDELIER CHAIN**

SOLD PER METRE

- H0615001 - 16mm Brass
- H0615002 - 16mm CP
- H0615011 - 19mm Brass
- H0615021 - 19mm CP

**PLASTIC NYLON OVAL LINK  
CHAIN**

SOLD PER METRE

- Z4015001 - 27MM WHITE
- Z4015002 - 33MM WHITE
- Z4015004 - 27MM BLACK
- Z4015005 - 33MM BLACK

**PLASTIC ORNAMENTAL  
CHAIN**

SOLD PER METRE

- Z4015003 - 39MM WHITE

**HOOKS FOR  
CONCRETE POSTS**



- Z4014531 - Single Hook Galvanised
- Z4014532 - Double Hook Galvanised

**HOOK ON PLATE**



- Z4014533 - Galvanised

**STAPLE ON PLATE**



- Z4014530 - Galvanised

**SPLIT CONNECTING LINKS**



- Z4014534 - Galvanised

**DEE SHACKLE**



- Z4014535 - 44mm Galvanised

**QUICK REPAIR LINKS**



- Z4014545 - 28x10 Zinc Plated
- Z4014546 - 32x11 Zinc Plated
- Z4014547 - 39x12 Zinc Plated
- Z4014548 - 46x14 Zinc Plated
- Z4014549 - 52x16 Zinc Plated

## Clothes Driers



### DOMESTIC TUBULAR FRAME & LOOSE GROUND SOCKET

- Z4018521 - 90' Line Galvanised
- Z4018522 - 120' Line Galvanised
- Z4018524 - 90' Spare Line
- Z4018525 - 120' Spare Line

### DELUXE MODEL WITH 3 ALUMINIUM ARMS & LOOSE SOCKET

- Z4018532 - 130' line, aluminium

### CADET MODEL WITH 3 PVC COATED STEEL ARMS

- Z4018531 - 95' Line Galvanised

### MAJOR MODEL WITH 4 ALUMINIUM ARMS & LOOSE SOCKET

- Z4018533 - 150' Line

### ACCESSORIES FOR ROTARY CLOTHES AIRERS

- Z4018523 - Soilspear socket for Domestic Range
- Z4018534 - Additional Sockets for Cadet, Deluxe & Major Models
- Z4018603 - Additional Sockets for 4 Arm Non Folding Models

HIDALINE 5 EXTENDS UP TO 4  
METRES GIVING APPROXIMATELY  
21.3 METRES OF LINE



- Z4018701 - Beige/Cream

### 4 ARM NON FOLDING EXTRA HEAVY DUTY FOR PERMANENT INSTALLATION



- Z4018601 - 100' Galvanised

### 4 ARM NON FOLDING WITH HANDLE



- Z4018602 - 100' Galvanised

### SCREW PULLEY EPOXY BLACK



- H0616501 - 44mm

### UPRIGHT PULLEY BLACK



- Single Wheel  
H0617011 - 38mm
- Double Wheel  
H0617012 - 38mm

### LINE PULLEY GALVANISED



- H0617501 - 32mm

### TUBULAR STEEL LINE POSTS

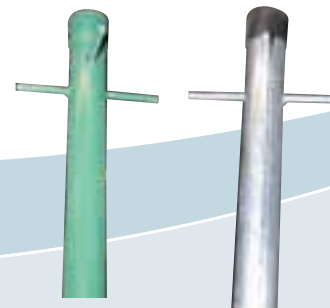

With Fixed Base Pegs

- Z4018501 - 2.44mtr - Green
  - Z4018502 - 2.7mtr - Green
  - Z4018503 - 2.44mtr - Galvanised
  - Z4018504 - 2.7mtr - Galvanised
- With Loose Ground Socket
- Z4018511 - 2.44mtr - Green
  - Z4018512 - 2.7mtr - Green
  - Z4018513 - 2.44mtr - Galvanised
  - Z4018514 - 2.7mtr - Galvanised

## Street Furniture

A wide range of street furniture is available to order. here we show a small selection of what is available for further information please call our sales office.

### CAST IRON BOLLARDS



Pavement Protector

Blackpool

Dublin

Oxford

Montrose

### TREE GRILLES



Square Tree Grille



Square Tree Grille



## Street Furniture

### ORNAMENTAL AND PLAIN BOLLARDS IN STEEL AND CAST IRON



Available to order in sizes from 48mm to 193mm diameter in fixed and removable variations

## Bicycle Racks & Shelters



A wide range of bicycle racks and shelters available to order. Please ask for details.

## Exterior Ashtrays



A variety of exterior and interior ashtrays are available to order upon request.

Z4019461 - LP100 Textured Green  
280w x 390h x 140d

Z4019462 - LP104 Textured Silver  
280w x 390h x 140d





**Parking Post**

**BROADGATE HINGED SECURITY POST**  
**LOCKABLE IN VERTICAL & HORIZONTAL POSITION**



**Z4019501 - 780 x 64mm Galvanised**  
 Requires 4 x H1012034 - bolts

**BROADGATE HINGED SECURITY POST**  
**BUILD IN PATTERN**



**Z4019502 - 780 x 64mm Galvanised**  
**Z4019503 - Spare pin to suit Broadgate Parking Post**

**BROADGATE FIXED BOUNDARY POST**



**BOLT FIX**  
**Z4019513 - 743 x 48mm Galvanised**  
 Requires 3 x H1012034 - bolts  
**BUILD IN PATTERN**  
**991MM OVERALL HEIGHT**  
**Z4019514 - 743 x 48mm Galvanised**

**AUTOPA HINGED POST WITH INTEGRAL FITTED LOCK CAN BE MASTER KEYED**



**Z4019511 - 743 x 65mm Galvanised**  
 Requires 2 x H1012041 - bolts

**AUTOPA HINGED POST ACCEPTS ALL STANDARD PADLOCKS**



**Z4019512 - 743 x 65mm Galvanised**  
 Requires 2 x H1012041 - bolts

**AUTOPA STEALTH POST**

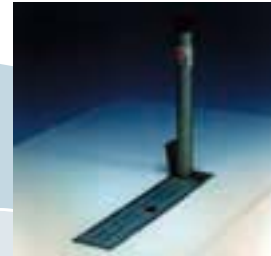

**Z4019615**

**Speed Ramps & Security products**

**SPEED RAMP**

A tough and economical ramp system, each section 50mm high, sold in pairs. Each pair comes with one black and one yellow section complete with necessary fixings.

**SPEED RAMP  
END SECTIONS**

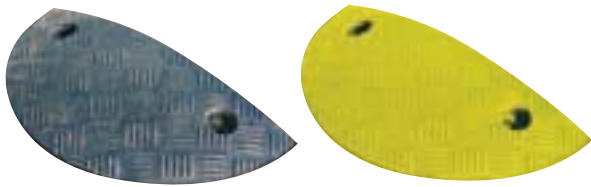

Z4019401 - Per Pair  
200mm Long  
470mm Wide

**SPEED RAMP  
CENTRE SECTIONS**

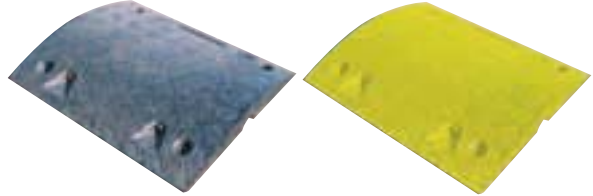

Z4019411 - Per Pair  
500mm Long  
470mm Wide

**SECURITY MIRRORS  
POST OR WALL FIXING**



Z4019421 - 600mm Diameter  
Z4019422 - 450mm Diameter

**SECURITY MIRRORS  
POST OR WALL FIXING**



Z4019431 - 600 x 400mm

**STANDARD WHEEL  
CLAMPS**

Range to fit most wheel sizes, folds for convenient storage with carry handle for ease of transportation. Steel construction with integral push in lock with 3 keys.



Z4019441 - KWC Small  
Z4019442 - KWC Medium  
Z4019443 - KWC Large  
Z4019444 - KWC Extra Large

**PROFESSIONAL WHEEL  
CLAMPS**

Constructed from tough steel with an adjustable arm and additional sections are available. Padlocks are supplied separately.



Z4019451 - KCK2 Medium  
Z4019452 - KCK2/L Large

**Keel Klamp System**



Keel Klamp is an extremely adaptable modular system of Galvanised Tubing and Cast clamps which can be easily assembled to form a variety of structures to suit your requirements. Shown here in our stock size of 48mm outside diameter, the tube and fittings are available to order in other sizes and colours to special order.

**10/8  
SIMPLE TEE**



Z4019701 - 48mm

**14/8  
EXTERNAL STRAIGHT  
CONNECTOR**



Z4019711 - 48mm

**15/8  
90° ELBOW**



Z4019721 - 48mm

**20/8  
90° 3 WAY ELBOW**



Z4019731 - 48mm

**21/8  
CORNER WITH  
THROUGH CENTRE TUBE**



Z4019741 - 48mm

**25/8  
Long Tee**



Z4019751 - 48mm

**26/8  
2 WAY CROSS**



Z4019761 - 48mm

**35/8  
3 WAY CROSS**



Z4019771 - 48mm

**40/8  
4 WAY CROSS**



Z4019781 - 48mm

Builders Hardware

**Kee Klamp System**

**45/8**  
90° CROSS OVER



Z4019791 - 48mm

**61/8**  
STANDARD WALL PLATE



Z4019801 - 48mm

**62/8**  
BASE PLATE



Z4019811 - 48mm

**64/8**  
FACE FIXED BASE PLATE  
VERTICAL FIXING



Z4019821 - 48mm

**67/8**  
UPRIGHT PIVOT  
ADJUSTABLE FROM 0° TO 11°



Z4019831 - 48mm

**70/8**  
WALL BRACKET  
SIDE FIXED



Z4019841 - 48mm

**77/8**  
PLASTIC END PLUG



Z4019851 - 48mm

**86/8**  
MIDDLE RAIL PIVOT  
ADJUSTABLE FROM 0° TO 11°



Z4019861 - 48mm

**87/8**  
TOP RAIL PIVOT  
ADJUSTABLE FROM 0° TO 11°



Z4019871 - 48mm

**88/8**  
END JOINING PIVOT  
ADJUSTABLE FROM 0° TO 11°



Z4019881 - 48mm

**89/8**  
PIVOT WITH CENTRE  
VERTICAL TUBE ADJUSTABLE  
FROM 0° TO 11°



Z4019891 - 48mm

**HR8**  
HANDRAIL BRACKET

Z4019901 - 48mm

TUBE

Stocked in 3.25mtr lengths also available to order cut to size

Z4019951 - 48mm x 3.25mtr



## Power Tools and Accessories

We also have a large selection of power tools and accessories in stock from the DeWalt & Milwaukee ranges. Other brand names can normally be ordered within a few days





# N&C

## Building Materials



# Decorating Products

The following section details the vast and varying types of decorating products held in stock at N&C Building Materials, from paints and brushes, to varnishes, adhesives, cleaning products and all decorators sundries. The brand leaders featured include, Dulux, Rustins, Ronseal, Spontex and Hagasan, to name just a few.

## Dulux



### DULUX NON-D RIP GLOSS

- Durable gloss finish
- No undercoat needed
- For interior and exterior use
- 10-12m<sup>2</sup> per litre coverage

- D1007128 - Pure Brilliant White 750ml  
 D1007130 - Pure Brilliant White 2.5 Ltr  
 D1007218 - Black 750ml  
 D1007230 - Magnolia 750ml

### DULUX GLOSS

- D1007114 - Brilliant White 500ml  
 D1007116 - Brilliant White 1 Ltr  
 D1007118 - Brilliant White 2.5 Ltr

Full Dulux colour range available

### DULUX WEATHERSHIELD FLEXICOAT QUICK DRYING UNDERCOAT

- D1007166 - Brilliant White 750ml  
 D1007168 - Brilliant White 2.5 Ltr  
 D1007260 - Dark Grey 750ml  
 D1007262 - Dark Grey 2.5 Ltr  
 D1007266 - Red 750ml  
 D1007268 - Red 2.5 Ltr

### DULUX ONCE GLOSS

- Convenient tough one coat gloss finish
- No undercoat needed
- For interior and exterior use
- 10-12m<sup>2</sup> per litre coverage

- D1007132 - Pure Brilliant White 750ml  
 D1007134 - Pure Brilliant White 2.5 Ltr  
 D1007174 - Black 750ml

A full range of ready mixed colours also available.

### DULUX QUICK DRYING GLOSS

- D1007250 - Pure Brilliant White 750ml  
 D1007252 - Pure Brilliant White 2.5 Ltr

### DULUX UNDERCOAT

- D1007823 - Brilliant White 500ml  
 D1007825 - Brilliant White 1 Ltr  
 D1007827 - Brilliant White 2.5 Ltr

Available in colours

### PROFESSIONAL LIQUID GLOSS

- Professional high gloss finish
- Requires Dulux undercoat
- For interior and exterior use
- 16-18m<sup>2</sup> per litre coverage

- D1007120 - Pure Brilliant White 750ml  
 D1007122 - Pure Brilliant White 2.5 Ltr

### PROFESSIONAL UNDERCOAT

- D1007124 - Pure Brilliant White 750ml  
 D1007126 - Pure Brilliant White 2.5 Ltr

### DULUX SATIN WOOD

- Smooth satin finish
- For interior use
- No undercoat needed
- 15-17m<sup>2</sup> per litre coverage

- D1007136 - Pure Brilliant White 750ml  
 D1007138 - Pure Brilliant White 2.5 Ltr

### DULUX QUICK DRYING SATINWOOD

- D1007246 - Pure Brilliant White 750ml  
 D1007248 - Pure Brilliant White 2.5 Ltr

### DULUX VINYL MATT

- D1007140 - Pure Brilliant White 3 Ltr  
 D1007142 - Pure Brilliant White 5 Ltr  
 D1007143 - Pure Brilliant White 10 Ltr

Full colour range available in 1 litre, 2.5 litre & 5 litre

### DULUX FLEXICOVER

#### VINYLSILK

- D1007062 - Pure Brilliant White 2.5 Ltr  
 D1007058 - Pure Brilliant White 4.5 Ltr

### DULUX KITCHEN & BATHROOMS MOISTURE RESISTANT PAINT

- Durable Soft Sheen Finish
- Moisture resistant
- Easy to wipe clean
- Not suitable for showers
- 14m<sup>2</sup> per litre coverage
- 10 times tougher than conventional silk paint

Available in 1 litre & 2.5 litre Full colour range available

- D1007220 - Pure White 1 Ltr  
 D1007222 - Pure White 2.5 Ltr

### DULUX VINYL SILK

- D1007146 - Pure Brilliant White 2.5 Ltr  
 D1007148 - Pure Brilliant White 5 Ltr  
 D1007150 - Pure Brilliant White 10 Ltr

### DULUX WOOD PRIMER

- D1007234 - 750ml  
 D1007236 - 2.5 Ltr

### DULUX FLEXICOLOUR VINYL MATT

- D1007064 - Pure Brilliant White 2.5 Ltr  
 D1007066 - Pure Brilliant White 4.5 Ltr

### DULUX VINYL

#### SOFT SHEEN

- D1007152 - Pure Brilliant White 5 Ltr

Full colour range available in 1 litre, 2.5 litre & 5 litre

### DULUX QUICK DRYING PRIMER & UNDERCOAT

- D1007254 - 750ml  
 D1007256 - 2.5 Ltr

**Dulux Trade**



**DULUX METAL PRIMER**

D1007242 - 250ml

**DULUX WEATHERSHIELD SMOOTH**

D1007154 - Pure Brilliant White 5 Ltr  
D1007156 - Pure Brilliant White 10 Ltr

Full weathershield colour range available.

**DULUX WEATHERSHIELD STABILISING PRIMER**

D1007032 - 2.5 Ltr  
D1007038 - 5 Ltr

**DULUX PLASTER SEALER**

D1007240 - 2.5 litre

**DULUX WEATHERSHIELD TEXTURED**

D1007158 - Pure Brilliant White 5 Ltr  
D1007160 - Pure Brilliant White 10 Ltr

Full weathershield colour range available

**DULUX WEATHERSHIELD MULTI SURFACE FUNGICIDE WASH**

D1007040 - 1 Ltr  
D1007050 - 5 Ltr

**DULUX WEATHERSHIELD EXTERIOR GLOSS**

D1007162 - Pure Brilliant White 750ml  
D1007164 - Pure Brilliant White 2.5 Ltr  
D1007270 - Black 750 ml  
D1007272 - Black 2.5 Ltr

Full weathershield colour range available

**DULUX WEATHERSHIELD FLEXIBLE FILLER**

D1007052 - 200gm  
D1007054 - 450gm

**Crown Trade Paints**



**TRADE FULL GLOSS**

High performance decorative and protective finish. for wood and metal interior and exterior surfaces.

- Exceptionally hard wearing and flexible
- Excellent opacity and film-build
- Good gloss and colour retention

Typical Coverage: 16sq. metres per Ltr  
Drying Times: Touch dry 2-4 hours  
Recoatable: 16 hours

D1040236 - 5 Ltr Brilliant White  
D1040238 - 2.5 Ltr Brilliant White  
D1040248 - 1 Ltr Brilliant White  
D1040244 - 5 Ltr White  
D1040246 - 2.5 Ltr White  
D1040248 - 1 Ltr White  
D1040252 - 5 Ltr Magnolia  
D1040254 - 2.5 Ltr Magnolia  
D1040255 - 1 Ltr Magnolia

Full selection of Crown Trade Colours Available



**TRADE FULL UNDERCOAT**

High Quality undercoat for interior and exterior use - particularly for first decoration.

- Excellent obliteration
- Maximum gloss hold-out when overcoated
- Good edge retention

Typical Coverage: 18sq. metres per ltr  
Drying Times: Touch dry 2-3 hours  
Overcoatable: 16 hours

D1040314 - 5 Ltr White  
D1040316 - 2.5 Ltr White  
D1040318 - 1 Ltr White

Full selection of Crown Trade Colours Available



**TRADE MATT VINYL**

Premium quality finish for interior walls and ceilings.

- Fast Drying
- High opacity
- First class colour retention

Typical Coverage: 15sqm. metres per litre.  
Drying Times: Touch dry 1-2 hours  
Recoatable: 4 hours

D1040000 - 5 Ltr Brilliant White  
D1040002 - 2.5 Ltr Brilliant White  
D1040004 - 10 Ltr White  
D1040006 - 5 Ltr White  
D1040008 - 2.5 Ltr White  
D1040012 - 5 Ltr Magnolia  
D1040014 - 2.5 Ltr Magnolia



## Crown Trade Paints



### TRADE MID SHEEN VINYL

Attractive mid sheen emulsion for interior walls and ceilings.

- Tough and washable
- Fast drying
- Attractive mid sheen finish

Typical Coverage: 14 sq. metres per ltr  
Drying Times: Touch dry 1-2 hours  
Recoatable: 16 hours

D1040104 - 5 Ltr Brilliant White

Full selection of Crown Trade Colours Available

### OBLITERATING EMULSION COVERMATT

Specially formulated emulsion for decorating new interior surfaces.

- Exceptionally High Opacity
- Allows Surface to breathe
- Fast Drying

D1040206 - 10 Ltr White  
D1040210 - 10 Ltr Magnolia

Full selection of Crown Trade Colours Available

### TRADE SILK VINYL

Premium quality finish for interior walls and ceilings, particularly kitchens/bathrooms.

- Tough, washable finish
- Fast drying
- Low odour, high opacity
- Good colour retention

Typical Coverage: 14sq. metres per ltr  
Drying Times: Touch dry 1-2 hours  
Recoatable: 4 hours

D1040048 - 5 Ltr Brilliant White  
D1040046 - 2.5 Ltr Brilliant White  
D1040054 - 5 Ltr White  
D1040056 - 2.5 Ltr White  
D1040060 - 5 Ltr Magnolia  
D1040062 - 2.5 Ltr Magnolia

Full selection of Crown Trade Colours Available

### TRADE ACRYLIC EGGSHELL

Acrylic formulation for interior use particularly suitable for painting projects where fast completion is important.

- Excellent durability
- Fast Drying
- Very low odour
- Extended sheen retention

Typical Coverage: 12sq. metres per litre.  
Drying Times: Touch dry 1-2 hours  
Recoatable: 4 hours

D1040088 - 5 Ltr White  
D1040092 - 5 Ltr Magnolia

Full selection of Crown Trade Colours Available

### TRADE SATIN FINISH

A tough, durable formulation, offering a washable satin finish for interior woodwork and metalwork.

- Excellent durability
- Elegant satin finish

Typical Coverage: 16 sq. metres per ltr  
Drying Times: Touch Dry. 3-4 hours  
Recoatable: 16 hours

D1040168 - Brilliant White 5 Ltr

Full selection of Crown Trade Colours Available

### TRADE OIL BASED LOW ODOUR EGGSHELL

High Quality finish for interior use where exceptional resistance to wear, dirt and steam is required.

- Excellent durability
- Low odour
- Smooth sheen finish

Typical Coverage: 16sq. metres per ltr  
Drying Times: Touch dry 2-3 hours  
Recoatable: 16 hours

D1040136 - 5 Ltr White  
D1040138 - 2.5 Ltr White  
D1040140 - 5 Ltr Magnolia  
D1040142 - 2.5 Ltr Magnolia

Full selection of Crown Trade Colours Available

### STRONGHOLD TEXTURED

For use on exterior wall finishes providing a durable, weather - resistant coating.

Typical Coverage: 7 sq. metres on smooth surfaces.  
Drying Times: Touch Dry. 1-2 hours  
Recoatable: 4 hours

D1044002 - 5 Ltr White

Full selection of Crown Trade Colours and 10 Ltr sizes Available

### STRONGHOLD SMOOTH

For use on exterior wall finishes providing a durable, weather - resistant coating.

Typical Coverage: 10 sq. metres on smooth surfaces.

Drying Times: Touch Dry. 1-2 hours  
Recoatable: 4 hours

D1044004 - 5 Ltr White

Full selection of Crown Trade Colours and 10 Ltr sizes Available

### STRONGHOLD STABILISING PRIMER

For binding loosely-bound, powdery and flaking surfaces

D1044006 - 5 Ltr White

### STRONGHOLD EXTERIOR GLOSS

Specially formulated high gloss paint for long term protection of exterior wood can also be used on primed metal.

Typical Coverage: 17sq. metres per litre.  
Drying Times: Touch dry 4-6 hours  
Recoatable: 16 hours

D1044008 - 2.5 Ltr White

A full selection of Crown Trade colours available

### STRONGHOLD FUNGICIDAL SOLUTION

Liquid concentrate for diluted use to kill moulds algae and other organic growths.

D1044010 - 5 Ltr White

**Crown Trade Paints**



**STRONGHOLD ALKALI RESISTING PRIMER**

For bare, dry, alkaline surfaces such as lime plaster cement and concrete. Use prior to application of water thinned paints.

D1044012 - 5 Ltr

**STRONGHOLD EXTERIOR PRIMER/UNDERCOAT**

Specially formulated for use with Stronghold Exterior Gloss.

Typical Coverage: 15sq. metres per ltr.  
Drying Times: Touch dry 4-6 hours  
Recoatable: 16 hours

D1044014 - 2.5 Ltr White  
Also available in colours



**STRONGHOLD SILICONE WATERPROOFING LIQUID**

For waterproofing porous exterior walls (including Brickwork stone work and cement rendered surfaces). Not for wood, canvas and fabrics

D1044016 - 5 Ltr

**UNIVERSAL PRIMER**

Primer providing a sound base for decoration on correctly prepared softwoods and metal, including galvanised surfaces.

D1044017 - 1 Ltr  
D1044018 - 5 Ltr



**WOOD PRIMER**

General purpose high quality primer for softwoods, chipboards etc.

D1044030 - 5 Ltr White  
D1044032 - 2.5 Ltr White  
D1044034 - 1 Ltr White  
D1044036 - 5 Ltr Pink  
D1044038 - 2.5 Ltr Pink

**ZINC PHOSPHATE PRIMER**

High quality metal primer for most ferrous, non-ferrous metals and aluminum alloys. May also be used on dry, glazed bricks, tiles and similar smooth surfaces.

D1040898 - 1 Ltr  
D1040899 - 5 Ltr

**Crown Timonox Paint**



**CROWN TIMONOX FLAME RETARDANT PAINTS**

Timonox is a way of providing a durable decorative finish with the added benefit of flame retardant properties. When flames and heat make contact with the surface of a timonox system a reaction takes place which inhibits the spread of flame across its surface. In a fire situation this means valuable time is allowed for escape.

**CROWN TIMONOX UNDERCOAT**

A solvent borne undercoat for new softwood surfaces

D1010050 - 2.5 Ltr White (White Only)



**CROWN TIMONOX SILK**

A waterborne, mid sheen paint for wall and ceiling surfaces.

D1010100 - 5 Ltr White

Other colours available to order

**CROWN TIMONOX MATT**

A waterborne matt paint for wall and ceiling surfaces

D1010110 - 5 Ltr White

Other colours available to order

**CROWN TIMONOX EGGSHELL**

A solvent borne, mid sheen paint for wall and ceiling surfaces

D1010200 - 5 Ltr Brilliant White

Other colours available to order



**CROWN TIMONOX ACRYLIC EGGSHELL**

A waterborne, mid sheen paint for wall and ceiling surfaces

D1010250 - 5 Ltr Brilliant White

**CROWN TIMONOX INTUMESCENT BASECOAT**

A waterborne, high build coating, which in contact with fire, produces a thick intumescent layer. Must be overcoated with a suitable Timonox finish.

D1010300 - 5 Ltr White (White Only)

**CROWN TIMONOX GLOSS**

A solvent borne gloss paint for use in conjunction with Crown Timonox undercoat and intumescent basecoat.

D1010160 - 5 Ltr White



## Macphersons



### MACPHERSON GLOSS

A durable high-gloss finish suitable for decoration and preservation of interior & exterior surfaces.

- D1011416 - Brilliant White 5 Ltr
- D1011415 - Brilliant White 2.5 Ltr
- D1011414 - Brilliant White 1 Ltr
- D1011426 - Magnolia 5 Ltr
- D1011425 - Magnolia 2.5 Ltr
- D1011428 - Magnolia 1 Ltr
- D1011432 - Black 5 Ltr
- D1011431 - Black 2.5 Ltr
- D1011430 - Black 1 Ltr

### MACPHERSON ACRYLIC GLOSS

A quick drying, self undercoating waterborne subtle gloss finish.

- D1011423 - Brilliant White 5 Ltr
- D1011424 - Brilliant White 2.5 Ltr
- D1011420 - Magnolia 5 Ltr
- D1011421 - Magnolia 2.5 Ltr

### MACPHERSON VINYL SILK

A durable silk finish for the decoration and preservation of interior surfaces.

- D1012216 - Brilliant White 5 Ltr
- D1012215 - Brilliant White 2.5 Ltr
- D1012226 - Magnolia 5 Ltr
- D1012228 - Magnolia 2.5 Ltr
- D1012231 - Black 5 Ltr
- D1012233 - Black 2.5 Ltr

### MACPHERSON UNDERCOAT

Suitable for use under gloss paints in interior or exterior surfaces.

- D1011616 - White 5 Ltr
- D1011615 - White 2.5 Ltr
- D1011614 - White 1 Ltr
- D1011632 - Deep Grey 5 Ltr
- D1011631 - Deep Grey 2.5 Ltr
- D1011630 - Deep Grey 1 Ltr

### MACPHERSON ACRYLIC EGGSHELL

A quick drying waterborne alternative to conventional eggshell finish.

- D1011834 - Brilliant White 5 Ltr
- D1011836 - Magnolia 5 Ltr

### MACPHERSON ECLIPSE EMULSION

An economical matt wall finish for interior use, ideal for new plaster.

- D1012408 - Brilliant White 15 Ltr
- D1012418 - Brilliant White 10 Ltr
- D1012416 - Magnolia 15 Ltr
- D1012414 - Magnolia 10 Ltr

### MACPHERSON LOW ODOUR EGGSHELL

A durable sheen finish suitable for use on interior surfaces. Recommended for use on surfaces subject to condensation.

- D1011816 - Brilliant White 5 Ltr
- D1011815 - Brilliant White 2.5 Ltr
- D1011826 - Magnolia 5 Ltr
- D1011825 - Magnolia 2.5 Ltr
- D1011831 - Black 5 Ltr
- D1011830 - Black 2.5 Ltr

### MACPHERSON VINYL MATT

An attractive matt finish suitable for the decoration and preservation of interior surfaces.

- D1012016 - Brilliant White 5 Ltr
- D1012014 - Brilliant White 2.5 Ltr
- D1012026 - Magnolia 5 Ltr
- D1012025 - Magnolia 2.5 Ltr
- D1012031 - Black 5 Ltr
- D1012030 - Black 2.5 Ltr

### MACPHERSON UNIVERSAL PRIMER

An alkali/oil based primer for use on wood, iron, steel, aged plaster, concrete and most non-ferrous metals.

- D1012807 - White 5 Ltr
- D1012805 - White 2.5 Ltr

### MACPHERSON RED OXIDE PRIMER

A low cost metal primer for use on ferrous metal where corrosion conditions are not exacting.

- D1013006 - 5 Ltr
- D1013805 - 2.5 Ltr

### MACPHERSON ACRYLIC PRIMER/UNDERCOAT

A fast drying dual role primer & undercoat.

- D1014406 - White 5 Ltr
- D1014405 - White 2.5 Ltr

### MACPHERSON ALKALI RESISTING PRIMER

Primer/sealer specifically designed to seal new plaster, concrete.

- D1014206 - White 5 Ltr

### MACPHERSON ALUMINIUM WOOD PRIMER

Provides an effective metallic barrier. Suitable for use on oily or resinous softwoods and all hardwoods.

- D1012810 - Metallic Grey 5 Ltr
- D1012808 - Metallic Grey 1 Ltr

### MACPHERSON WOOD PRIMER

An oil/alkali based primer suitable for interior and exterior surfaces especially recommended for use on new timber.

- D1013416 - White 5 Ltr
- D1013415 - White 2.5 Ltr
- D1013414 - White 1 Ltr

### MACPHERSONS STABILISING SOLUTION

A highly penetrating, clear solution for application to pliable or chalking surfaces, to produce a substrate suitable for decoration.

- D1020412 - 5 Ltr

## Sandtex



### SANDEX FINE TEXTURED MATT

Long Established, high quality, finely textured masonry paint.

- BBA certified, 15 years durability
- Very Fine Aggregate for superior proven durability
- High opacity
- Easy application by brush, roller or spray (not airless)

Typical Coverage: 3-6.5sq. metres per ltr  
Depending upon surface texture and porosity.

Drying Times: 4-6 hours

D0903002 - Brilliant White 5Ltr

Available in full Sandtex colour Range

### SANDEX HIGH COVER SMOOTH

A smooth masonry paint formulated especially for the professional user.

- BBA certified, 10 years durability
- High opacity
- Quick easy application by brush, roller or airless spray

Typical Coverage: 8-12.sq. metres per ltr  
Depending upon surface texture and porosity.

Drying Times: 3-5 hours

D0903124 - Brilliant White 5Ltr  
D0903130 - Magnolia 5Ltr

Available in full Sandtex Colour range

### SANDEX 365 ALL WEATHER

Based on the high performance Pliolite® resin 365 All Weather™ is a result of the cooperation of two leading chemical companies, Goodyear Chemicals and Akzo Nobel.

Formulated for the professional user.

- Dries in adverse weather conditions
- Durable protection up to 15 years BAA Certified
- This product also contains a fungicide/algicide for the sole purpose of protecting the applied film

Typical Coverage: 10 sq. metres per ltr  
Depending upon surface texture and porosity.

Drying Times: Touch dry time and rain resistant time depend on weather conditions and film thickness applied.

Recoat: 16 hours

D0903150 - 5 Ltr

Available in full Sandtex colour Range

### SANDEX TRADE FLEXIGLOSS

A high performance exterior gloss system providing greater resistance to cracking and flaking than a traditional gloss with longer lasting protection.

- For use on suitably primed exterior wood and metal
- High gloss finish and excellent colour retention
- Specially formulated for long term protection
- Contains effective fungicide/algicide for the sole purpose of protecting the applied film

Typical Coverage: 17sq. metres per ltr

Drying Times: 4-6 hours

Recoat: After 16 hours

D0903155 - Brilliant White 2.5 Ltr  
D0903156 - Brilliant White 5 Ltr

### SANDEX HIGH BUILD/FINEBUILD

Advanced decorative and protective coatings ideal for the renovation of uneven and irregular surfaces. Fine Build has a more finely textured finish.

- High Build - BBA certified 15 years durability
- For exterior and interior use Covers undulations and uneven surfaces in one coat
- Gives an attractive and durable finish to new areas
- In-built flexibility to compensate for normal building movement
- Minimal preparation required
- Tough durable finish

D0903160 - 15kg White

Available in full Sandtex Colour range

### SANDEX STABILISING SOLUTION

A high penetrative colourless surface stabiliser for chalking, weathered and porous surfaces. Endorsed by the BAA.

Typical Coverage: 3-6.sq. metres per ltr  
depending on surface and porosity.

Drying Times: 12 hours

D0903170 - 2.5 Ltr  
D0903171 - 5 Ltr  
D0903172 - 20 Ltr

### SANDEX EASIPLAST

A high performance polymer modified masonry filler and repair mortar for application to most sound exterior masonry surfaces.

D0903180 - 2kg Box

D0903181 - 6kg Box

### SANDEX DIRT REPELLENT

A colourless protective coating which minimises dirt retention on exterior masonry coatings.

- Quick and easy to apply
- Prevents the accumulation of dirt deposits, even in industrial areas
- Inhibits mould growth
- High spreading Rate
- Excellent adhesion to all matt masonry coatings

Typical Coverage: 15-25 sq. metres per ltr  
depending on surface texture and porosity.

Drying Times: 1-2 hours

D0903190 - 2 Ltr  
D0903191 - 5 Ltr

### SANDEX FUNGICIDE

An easily applied concentrated treatment to kill organic growth and help prevent its reappearance.

Typical Coverage: 10-30.sq. metres per ltr  
depending on surface and porosity.

Drying Times: 24 hours

D0903175 - 1 Ltr  
D0903176 - 5 Ltr

### SANDEX SYSTEM PRIMER

An Acrylic polymer-based primer and polyester membrane for use on denatured plywood and to bridge panel joints. Decorate with Sandtex Textured Coatings.

- Panel system Membrane

Typical Coverage: Scrimming 3m<sup>2</sup> per litre, priming 5-6m<sup>2</sup> per litre.

Drying Times: 24 hours

D0903185 - 10 Ltr

## Coovar



### COOVAR FLOORCOTE

A Rubberised floor coating providing excellent resistance to solvents and chemical solutions.

For use inside or outside.

Exceptional resistance to spills, solvents water etc.

D1026005	- Tile Red	2.5Ltr
D1026006	- Tile Red	5Ltr
D1025035	- Black	2.5Ltr
D1025036	- Black	5Ltr
D1025010	- Clear	2.5Ltr
D1025011	- Clear	5Ltr
D1025015	- White	2.5Ltr
D1025016	- White	5Ltr
D1025405	- Gull Grey	2.5Ltr
D1025406	- Gull Grey	5Ltr
D1025020	- Laurel Green	2.5Ltr
D1025021	- Laurel Green	5Ltr
D1025040	- Dolphin Blue	2.5Ltr
D1025041	- Dolphin Blue	5Ltr
D1025045	- Carnival Red	2.5Ltr
D1025046	- Carnival Red	5Ltr

### COOVAR ROAD LINE MARKING PAINT

A fast drying spirit based paint which can be applied directly to tarmac inside or outside for marking specific areas.

D1030815	- White	2.5 Ltr
D1030816	- White	5 Ltr
D1030865	- Yellow	2.5 Ltr
D1030866	- Yellow	5 Ltr

D1030868	- Road Line Marking Paint Thinner	2.5 Ltr
----------	-----------------------------------	---------

### COOVAR FLOOR PAINT

A single pack floorcoating, easy to use, versatile and economical. Ideal to protect and decorate floors inside and outside.

Not Suitable for wet areas.

D1026390	- Tan	5 Ltr
D1026392	- Stone	5 Ltr
D1026394	- Light Grey	5 Ltr
D1026396	- Safety Yellow	5 Ltr
D1026410	- Tile Red	5 Ltr
D1026608	- Bright Red	5 Ltr
D1026610	- Flint Grey	5 Ltr
D1027008	- Forest Green	5 Ltr
D1027208	- Steel Blue	5 Ltr
D1027818	- White	5 Ltr
D1027838	- Black	5 Ltr
D1027848	- Dark Grey	5 Ltr

### COOVAR ROAD LINE MARKING AEROSOL

Ideal for line and spot marking on large range of surfaces.

D1030870	- Yellow	750ml
D1030872	- Black	750ml
D1030874	- White	750ml
D1030876	- Red	750ml
D1030878	- Blue	750ml
D1030880	- Green	750ml

D1030812	- Z Wheel Road Line Aerosol Additional	
----------	--	--

### COOVAR SURE GRIP

A ready mixed aggregated floor coating which provides a rough antislip finish when dry.

For use inside and outside . Ideal for Ramps.

D1027851	- Red	5 Ltr
D1027853	- Green	5 Ltr
D1027861	- Blue	5 Ltr
D1027865	- White	5 Ltr
D1027871	- Light Grey	5 Ltr
D1027875	- Grey	5 Ltr
D1027831	- Yellow	5 Ltr
D1027885	- Black	5 Ltr

### COOVAR VANDALENE ANTI CLIMB PAINT

A thick single pack non-drying sticky product. Helps protect property from intruders.

Used on window ledges, down pipes walls, gutters or anywhere which may be used as a grip point to gain unauthorised access.

D1031035	- Black	2.5 Ltr
D1031036	- Black	5 Ltr
D1031206	- Grey	5 Ltr
D1031406	- Green	5 Ltr
D1031606	- Tile Red	5 Ltr

### VANDALENE SIGNS

(For notification and Deterrence)

To be shown clearly where the anti climb paint has been used.

D1031610	- A5 Size Plastic	
D1031611	- A4 Size Plastic	

### COOVAR ANTI-CORROSIVE RED OXIDE

A strong alkyd based red oxide product applied direct to metal surfaces.

Uses include structural Steel, General metalwork, tanks, iron gates or pipes

D1031620	- 250 ml
D1031621	- 500 ml
D1031622	- 1 Ltr
D1031623	- 2.5 Ltr
D1031624	- 5 Ltr

### COOVAR ZINC PHOSPHATE PRIMER

A high performance rust inhibiting metal primer.

Ideal when timber and metal are combined in the same structure - will prime both surfaces.

D1036140	- Red	1 Ltr
D1036141	- Red	2.5 Ltr
D1036142	- Red	5 Ltr
D1036145	- Grey	1 Ltr
D1036146	- Grey	2.5 Ltr
D1036147	- Grey	5 Ltr

### COOVAR RED OXIDE METAL PRIMER

A good general purpose metal primer for ferrous metallic objects.

D1031630	- 250 ml
D1031631	- 500 ml
D1031632	- 1 Ltr
D1031633	- 2.5 Ltr
D1031634	- 5 Ltr

### COOVAR SOLAR REFLECTIVE PAINT

An Acrylic bright white Aggregated coating. Used to protect felt roofs and reduce heat build up in roofs and internal areas.

D1034712	- White	5Ltr
----------	---------	------

An oil based paint giving a high reflective metallic sheen.

D1034711	- Aluminium	5Ltr
----------	-------------	------

### COOVAR THINNER

D1026300	- 2.5 Ltr
----------	-----------



## Zinsser



### ZINSSER BULLS EYE 1-2-3 PRIMER/SEALER STAIN KILLER/BOND COAT

- Acrylic/Waterbased
- Great for all purpose interior and exterior priming
- Compatible with all oil and waterbased topcoats
- Flexible dry film resists cracking and peeling
- Excellent adhesion to glossy, chalky and hard to paint surfaces
- Can be overpainted in 1 hour

D1070002 - White 3-78 Ltr (US Gallon)  
D1070004 - White 946ml (US Quart)

### ZINSSER PERMA-WHITE MILDEW PROOF BATHROOM PAINT

- Available in satin or semi-gloss
- 5 year mildew proof guarantee
- Moisture resistant, plister proof
- Self priming-adheres to gloss paints, vinyl wallcoverings, formica and other hard-to-stick surfaces
- Washable
- Waterbased
- Ideal for use in bathrooms, kitchens, basements etc

D1070020 - White Satin 3-78 Ltr (US Gallon)  
D1070022 - White Satin 946ml (US Quart)  
D1070024 - White Semi Gloss 3-78 Ltr (US Gallon)  
D1070026 - White Semi Gloss 946ml (US Quart)

### ZINSSER B-I-N PRIMER/SEALER/STAIN KILLER

- Premier stain killer
- Blocks water stains
- Blocks smoke stains
- Completely seals in odours from smoke and fire damage
- Dries in 15 minutes can be recoated in 45 minutes
- Primes and seals all interior surfaces including flocks
- Bonds tightly to glass, glazed tiles, metal and other glossy surfaces

D1070006 - White 3-78 Ltr (US Gallon)  
D1070008 - White 946ml (US Quart)  
D1070010 - White 473ml (US Pint)  
D1070012 - White 13oz aerosol

### ZINSSER COVER STAIN

- Primer for all interior and exterior surfaces
- Kills stains - water, crayon, ink, graffiti etc
- Compatible with all oil based and water based topcoats.
- Fast drying - can be over painted in 1 hour
- Suitable for glossy surfaces

D1070014 - White 3-78 Ltr (US Gallon)  
D1070016 - White 946ml (US Quart)  
D1070018 - White 13oz Aerosol

## Hammerite

### HAMMERITE BRUSH CLEANER & THINNER

Due to the unique formulation of Hammerite metal finishes brushes and equipment must be cleaned using this product. Also for thinning Hammerite metal finishes when spray applying.

D7000300 - 250ml  
D7000302 - 500ml  
D7000304 - 1 Ltr  
D7000306 - 2.5 Ltr  
D7000308 - 5 Ltr

### HAMMERITE GARAGE DOOR ENAMEL

Tough durable high gloss finish for garage doors, no undercoat required highly resistant to flaking. Easy to apply to vertical surfaces.

D7000310 - White 750ml  
D7000312 - Black 750ml

### HAMMERITE RADIATOR ENAMEL

Specially formulated to provide a heat resistant brilliant white finish on waterfilled household radiators and hot water pipes. Resists yellowing and prevents rust. Low odour.

D7000328 - Gloss White 250ml  
D7000330 - Gloss White 500ml  
D7000332 - Gloss White 400ml Aerosol  
D7000334 - Satin White 250ml  
D7000336 - Satin White 500ml  
D7000338 - Satin White 400ml Aerosol



### HAMMERITE KURUST ONE COAT RUST CONVERTING PRIMER

Stabilises and converts rust into soluble metallo-organic complexes. Primes surfaces ready for application of undercoat/topcoat.

D7000368 - 250ml

### HAMMERITE SPECIAL METALS PRIMER

Waterbased primer to promote adhesion to all non-ferrous metals.

For priming galvanised and stainless steel, aluminium, chrome, brass and copper.

D7000390 - Light Grey 2.5 Ltr  
D7000389 - Light Grey 250ml  
D7000394 - Brick Red 2.5 Ltr  
D7000392 - Brick Red 250ml

## Hammerite

Corrosion Resistant decorative Coatings.

A highly durable decorative protective coating for all ferrous and non-ferrous metals, also suitable for use on wood and some plastics. Ideal for structural steelwork, cast iron work, railings, down pipes etc.

- Fast Drying
- Highly effective barrier to moisture
- Corrosion resistant
- Available in hammered and smooth finishes.



### SMOOTH METAL FINISH

D7000002	- Black	250ml
D7000004	- Black	500ml
D7000006	- Black	1 Ltr
D7000008	- Black	2.5 Ltr
D7000010	- Black	5 Ltr
D7000012	- Black	400ml Aerosol
D7000014	- White	250ml
D7000016	- White	500ml
D7000018	- White	1 Ltr
D7000020	- White	2.5 Ltr
D7000022	- White	5 Ltr
D7000024	- White	400ml Aerosol
D7000026	- Silver	250ml
D7000028	- Silver	500ml
D7000030	- Silver	1 Ltr
D7000032	- Silver	2.5 Ltr
D7000034	- Silver	5 Ltr
D7000036	- Silver	400ml Aerosol
D7000038	- Blue	250ml
D7000040	- Blue	500ml
D7000042	- Blue	1 Ltr
D7000050	- Red	250ml
D7000052	- Red	500ml
D7000054	- Red	1 Ltr
D7000062	- Green	250ml
D7000064	- Green	500ml
D7000066	- Green	1 Ltr
D7000072	- Green	400ml Aerosol
D7000074	- Dark Green	250ml
D7000078	- Dark Green	500ml
D7000076	- Dark Green	1 Ltr
D7000086	- Yellow	250ml
D7000088	- Yellow	500ml
D7000090	- Yellow	1 Ltr
D7000098	- Dark Brown	250ml
D7000100	- Dark Brown	500ml
D7000102	- Dark Brown	1 Ltr
D7000110	- Magnolia	250ml
D7000112	- Magnolia	500ml
D7000122	- Magnolia	1 Ltr
D7000118	- Burgundy	250ml
D7000120	- Burgundy	500ml
D7000122	- Burgundy	1 Ltr
D7000128	- Burgundy	400ml Aerosol
D7000130	- Dark Blue	250ml
D7000132	- Dark Blue	500ml
D7000134	- Dark Blue	1 Ltr
D7000142	- Gold	250ml
D7000144	- Gold	500ml
D7000146	- Gold	1 Ltr
D7000152	- Gold	400ml Aerosol
D7000154	- Grey	250ml
D7000156	- Grey	500ml
D7000158	- Grey	1 Ltr

### HAMMERED METAL FINISH

D7000166	- Black	250ml
D7000168	- Black	500ml
D7000170	- Black	1 Ltr
D7000172	- Black	2.5 Ltr
D7000174	- Black	5 Ltr
D7000176	- Black	400ml Aerosol
D7000178	- White	250ml
D7000180	- White	500ml
D7000182	- White	1 Ltr
D7000184	- White	2.5 Ltr
D7000186	- White	5 Ltr
D7000188	- White	400ml Aerosol
D7000190	- Silver Grey	250ml
D7000192	- Silver Grey	500ml
D7000194	- Silver Grey	1 Ltr
D7000196	- Silver Grey	2.5 Ltr
D7000198	- Silver Grey	5 Ltr
D7000200	- Silver Grey	400ml Aerosol
D7000202	- Light Blue	250ml
D7000204	- Light Blue	500ml
D7000206	- Light Blue	1 Ltr
D7000212	- Dark Blue	250ml
D7000214	- Dark Blue	500ml
D7000216	- Dark Blue	1 Ltr
D7000218	- Dark Blue	2.5 Ltr
D7000222	- Dark Blue	400ml Aerosol
D7000224	- Mid Green	250ml
D7000226	- Mid Green	500ml
D7000228	- Mid Green	1 Ltr
D7000234	- Copper	250ml
D7000236	- Copper	500ml
D7000238	- Copper	1 Ltr
D7000240	- Deep Green	250ml
D7000242	- Deep Green	500ml
D7000244	- Deep Green	1 Ltr
D7000250	- Red	250ml
D7000252	- Red	500ml
D7000254	- Red	1 Ltr
D7000260	- Brown	250ml
D7000262	- Brown	500ml
D7000264	- Brown	1 Ltr
D7000270	- Grey	250ml
D7000272	- Grey	500ml
D7000274	- Grey	1 Ltr
D7000280	- Gold	250ml
D7000282	- Gold	500ml
D7000282	- Gold	1 Ltr



## Sadolin

### SADOLIN CLASSIC

Sadolin Classic is a well proven general purpose translucent woodstain, particularly suitable for cladding and roughsawn timber.

- Tough weather protection
- Long lasting colour
- Resists blistering & flaking

D1050000	- Light Oak	1 Ltr
D1050002	- Mais	1 Ltr
D1050004	- Antique Pine	1 Ltr
D1050006	- Burma Teak	1 Ltr
D1050008	- African Walnut	1 Ltr
D1050010	- Redwood	1 Ltr
D1050012	- Teak	1 Ltr
D1050014	- Rosewood	1 Ltr
D1050016	- Jacobean Walnut	1 Ltr
D1050018	- Dark Palisander	1 Ltr
D1050020	- Ebony	1 Ltr
D1050022	- Red	1 Ltr
D1050210	- Mahogany	1 Ltr
D1050030	- Light Oak	2.5 Ltr
D1050032	- Mais	2.5 Ltr
D1050034	- Antique Pine	2.5 Ltr
D1050036	- Burma Teak	2.5 Ltr
D1050038	- African Walnut	2.5 Ltr
D1050040	- Redwood	2.5 Ltr
D1050042	- Teak	2.5 Ltr
D1050044	- Rosewood	2.5 Ltr
D1050046	- Jacobean Walnut	2.5 Ltr
D1050048	- Dark Palisander	2.5 Ltr
D1050050	- Ebony	2.5 Ltr
D1050052	- Red	2.5 Ltr
D1050212	- Mahogany	2.5 Ltr
D1050060	- Light Oak	5 Ltr
D1050062	- Mais	5 Ltr
D1050064	- Antique Pine	5 Ltr
D1050066	- Burma Teak	5 Ltr
D1050068	- African Walnut	5 Ltr
D1050070	- Redwood	5 Ltr
D1050072	- Teak	5 Ltr
D1050074	- Rosewood	5 Ltr
D1050076	- Jacobean Walnut	5 Ltr
D1050078	- Dark Palisander	5 Ltr
D1050080	- Ebony	5 Ltr
D1050214	- Mahogany	5 Ltr

All other colours in the Sadolin Classic Range mixed to order



### SADOLIN EXTRA

Sadolin extra is a durable translucent woodstain which gives extra protection and is particularly suitable for joinery, doors & windows.

- Tough weather protection
- Long lasting colour
- Resists blistering & flaking

D1050090	- Light Oak	500ml
D1050092	- Mais	500ml
D1050094	- Antique Pine	500ml
D1050096	- Burma Teak	500ml
D1050098	- African Walnut	500ml
D1050100	- Redwood	500ml
D1050102	- Teak	500ml
D1050104	- Rosewood	500ml
D1050106	- Jacobean Walnut	500ml
D1050108	- Dark Palisander	500ml
D1050110	- Ebony	500ml
D1050112	- Red	500ml
D1050216	- Mahogany	500ml
D1050120	- Light Oak	1 Ltr
D1050122	- Mais	1 Ltr
D1050124	- Antique Pine	1 Ltr
D1050126	- Burma Teak	1 Ltr
D1050128	- African Walnut	1 Ltr
D1050130	- Redwood	1 Ltr
D1050132	- Teak	1 Ltr
D1050134	- Rosewood	1 Ltr
D1050136	- Jacobean Walnut	1 Ltr
D1050138	- Dark Palisander	1 Ltr
D1050140	- Ebony	1 Ltr
D1050142	- Red	1 Ltr
D1050218	- Mahogany	1 Ltr
D1050150	- Light Oak	2.5 Ltr
D1050152	- Mais	2.5 Ltr
D1050154	- Antique Pine	2.5 Ltr
D1050156	- Burma Teak	2.5 Ltr
D1050158	- African Walnut	2.5 Ltr
D1050160	- Redwood	2.5 Ltr
D1050162	- Teak	2.5 Ltr
D1050164	- Rosewood	2.5 Ltr
D1050166	- Jacobean Walnut	2.5 Ltr
D1050168	- Dark Palisander	2.5 Ltr
D1050170	- Ebony	2.5 Ltr
D1050172	- Red	2.5 Ltr
D1050220	- Mahogany	2.5 Ltr
D1050180	- Light Oak	5 Ltr
D1050182	- Mais	5 Ltr
D1050184	- Antique Pine	5 Ltr
D1050186	- Burma Teak	5 Ltr
D1050188	- African Walnut	5 Ltr
D1050190	- Redwood	5 Ltr
D1050192	- Teak	5 Ltr
D1050194	- Rosewood	5 Ltr
D1050196	- Jacobean Walnut	5 Ltr
D1050198	- Dark Palisander	5 Ltr
D1050200	- Ebony	5 Ltr
D1050222	- Mahogany	5 Ltr

All other colours in the Sadolin Extra Range mixed to order

### SADOLIN SUPERDEC

Sadolin Superdec has all the benefits of a woodstain its unique formulation offers a combination of extensibility and durability minimising the risk of flaking and peeling. Suitable for use on all timber, ideal where a complete change of colour is required, or on new timber.

D1050300	- White	1 Ltr
D1050302	- Walnut	1 Ltr
D1050304	- Black	1 Ltr
D1050312	- White	2.5 Ltr
D1050314	- Walnut	2.5 Ltr
D1050316	- Black	2.5 Ltr
D1050324	- White	5 Ltr
D1050326	- Walnut	5 Ltr
D1050328	- Black	5 Ltr

### PV 67 HEAVY DUTY VARNISH

For floors and work surfaces. A Fast drying system approach with which a highly professional finish can be achieved.

Hardwearing and scratch resistant

D200000	- 1 Ltr Gloss
D200001	- 1 Ltr Satin
D200004	- 5 Ltr Gloss
D200010	- 5 Ltr Satin

## Sikkens



**CETOL HLS**

A low build exterior wood stain containing fungicide for use on smooth planed softwoods and hardwoods as a base stain to Sikkens Filter 7. Can also be used as a three coat, single product finish on rough sawn timber or components subject to high levels of wear and abrasion such as garden furniture and handrails.

D1051000	Light Oak	1 Ltr
D1051002	Dark Oak	1 Ltr
D1051004	Walnut	1 Ltr
D1051006	Mahogany	1 Ltr
D1051008	Rosewood	1 Ltr
D1051010	Teak	1 Ltr
D1051012	Ebony	1 Ltr
D1051014	Pine	1 Ltr
D1051024	Light Oak	2.5 Ltr
D1051026	Dark Oak	2.5 Ltr
D1051028	Walnut	2.5 Ltr
D1051030	Mahogany	2.5 Ltr
D1051032	Rosewood	2.5 Ltr
D1051034	Teak	2.5 Ltr
D1051036	Ebony	2.5 Ltr
D1051038	Pine	2.5 Ltr



**CETOL FILTER 7**

A medium build, high durability finish coat for use over Cetol HLS, on smooth planed softwoods and hardwoods.

D1051126	Light Oak	1 Ltr
D1051128	Dark Oak	1 Ltr
D1051130	Walnut	1 Ltr
D1051132	Mahogany	1 Ltr
D1051134	Rosewood	1 Ltr
D1051136	Teak	1 Ltr
D1051138	Ebony	1 Ltr
D1051140	Pine	1 Ltr
D1051142	Light Oak	2.5 Ltr
D1051144	Dark Oak	2.5 Ltr
D1051146	Walnut	2.5 Ltr
D1051148	Mahogany	2.5 Ltr
D1051150	Rosewood	2.5 Ltr
D1051152	Teak	2.5 Ltr
D1051154	Ebony	2.5 Ltr
D1051156	Pine	2.5 Ltr

## Ronseal



**RONSEAL ULTRA TOUGH HARDGLAZE CLEAR GLOSS VARNISH**

Ultra tough polyurathane clear gloss varnish protects and highlights the true beauty of wood.

- Extremely tough and durable
- Heat, water and scratch resistant
- Long lasting protection

D4060000	250ml
D4060002	500ml
D4060006	1 Ltr
D4060008	2.5 Ltr



**RONSEAL QUICK DRYING VARNISH**

Unique 'Quick Drying' waterbased formulation combining convenience and performance to achieve beautiful results.

- Touch dry in 20 minutes
- Recoat in 2 hours
- Low solvent, low odour
- Unique polymer for maximum quality

D4060038	Clear Gloss	250ml
D4060040	Clear Gloss	750ml
D4060042	Clear Gloss	2.5 Ltr
D4060044	Clear Satin	250ml
D4060046	Clear Satin	750ml
D4060048	Clear Satin	2.5 Ltr
D4060050	Clear Matt	250ml
D4060052	Clear Matt	750ml
D4060054	Clear Matt	2.5 Ltr



**RONSEAL OUTDOOR VARNISH**

An ultra durable, long lasting all weather exterior varnish that protects smooth planed exterior wood. Ultra flexible alkyd resin - will not crack, peel or blister.

- Higher build formula
- Higher solid content
- Microporous - allows wood to breathe
- Longer lasting U.V. protection

D4060070	Clear Gloss	250ml
D4060072	Clear Gloss	750ml
D4060074	Clear Gloss	2.5 Ltr
D4060076	Clear Satin	250ml
D4060078	Clear Satin	750ml
D4060080	Clear Satin	2.5 Ltr

**Ronseal**



**COLRON WOOD DYE**

A cloth applied dye to penetrate into the woodgrain producing a rich depth of colour specially formulated to overcoat with Ronseal ultra tough varnish.

- One coat for total colour
- Professional beautiful finish
- Overcoat with Ronseal clear varnish

D4060426	• Mellow Pine	125ml
D4060428	• Victorian Pine	125ml
D4060430	• Antique Pine	125ml
D4060432	• Deep Mahogany	125ml
D4060434	• Red Mahogany	125ml
D4060436	• Peruvian Mahogany	125ml
D4040438	• English Light Oak	125ml
D4060440	• Georgian Medium Oak	125ml
D4060442	• Jacobean Dark Oak	125ml
D4060444	• Burmese Teak	125ml
D4060446	• American Walnut	125ml
D4060448	• Indian Rose Wood	125ml
D4060450	• Burmese Teak	250ml
D4060452	• Peruvian Mahogany	250ml
D4060454	• Indian Rosewood	250ml
D4060456	• Jacobean Dark Oak	250ml
D4060458	• Georgian Medium Oak	250ml
D4060460	• American Walnut	250ml
D4060462	• English Light Oak	250ml
D4060466	• Red Mahogany	250ml
D4040468	• Deep Mahogany	250ml
D4040470	• Antique Pine	250ml
D4040472	• Victorian Pine	250ml
D4060474	• Mellow Pine	250ml
D4060476	• Burmese Teak	500ml
D4060478	• Peruvian Mahogany	500ml
D4060480	• American Walnut	500ml
D4060482	• Indian Rosewood	500ml
D4060484	• Jacobean Dark Oak	500ml
D4060486	• English Light Oak	500ml
D4060488	• Georgian Medium Oak	500ml
D4060490	• Red Mahogany	500ml
D4060492	• Deep Mahogany	500ml
D4060494	• Antique Pine	500ml
D4060496	• Georgian Medium Oak	2.5 Ltr
D4060498	• English Light Oak	2.5 Ltr
D4060500	• Jacobean Dark Oak	2.5 Ltr
D4060502	• Indian Rosewood	2.5 Ltr
D4060504	• American Walnut	2.5 Ltr
D4060506	• Burmese Teak	2.5 Ltr
D4060508	• Peruvian Mahogany	2.5 Ltr

**RONSEAL QUICK DRYING FLOOR VARNISH**

For wooden floors subject to normal wear. Ideal for lounges, dining rooms, bedrooms and bathrooms

- Very tough and durable
- Good resistance to household chemicals and abrasion
- Light natural appearance
- Quick drying, touch dry in 20 mins
- Recoat after 2 hours

D4060310	• Gloss	750ml
D4060314	• Satin	750ml
D4060318	• Matt	750ml
D4060312	• Gloss	2.5 Ltr
D4060316	• Satin	2.5 Ltr
D4060320	• Matt	2.5 Ltr

**RONSEAL QUICK DRYING WOODSTAIN**

A unique quick drying waterbased formulation which colours, waterproofs and protects all exterior softwood & hardwood.

- Available in both gloss and satin finishes
- Touch dry in 20 mins
- Rainproof in 30 mins
- Recoatable after 4 hours
- Lasts longer than traditional woodstains
- Low odour
- Clean brushes out in water

D4060180	• Walnut Oak Gloss	250ml
D4060138	• Antique Oak Gloss	250ml
D4060162	• Mahogany Gloss	250ml
D4060156	• Deep Mahogany Gloss	250ml
D4060144	• Antique Pine Gloss	250ml
D4060168	• Rosewood Gloss	250ml
D4060174	• Teak Gloss	250ml
D4060150	• Dark Oak Gloss	250ml
D4060182	• Walnut Oak Gloss	750ml
D4060140	• Antique Oak Gloss	750ml
D4060164	• Mahogany Gloss	750ml
D4060158	• Deep Mahogany Gloss	750ml
D4060146	• Antique Pine Gloss	750ml
D4060170	• Rosewood Gloss	750ml
D4060176	• Teak Gloss	750ml
D4060152	• Dark Oak Gloss	750ml
D4060184	• Walnut Oak Gloss	2.5 Ltr
D4060142	• Antique Oak Gloss	2.5 Ltr
D4060166	• Mahogany Gloss	2.5 Ltr
D4060160	• Deep Mahogany Gloss	2.5 Ltr
D4060148	• Antique Pine Gloss	2.5 Ltr
D4060172	• Rosewood Gloss	2.5 Ltr
D4060178	• Teak Gloss	2.5 Ltr
D4060154	• Dark Oak Gloss	2.5 Ltr
D4060228	• Walnut Oak Satin	250ml
D4060186	• Antique Oak Satin	250ml
D4060210	• Mahogany Satin	250ml
D4060204	• Deep Mahogany Satin	250ml
D4060192	• Antique Pine Satin	250ml
D4060216	• Rosewood Satin	250ml
D4060222	• Teak Satin	250ml
D4060198	• Dark Oak Satin	250ml
D4060230	• Walnut Oak Satin	750ml
D4060188	• Antique Oak Satin	750ml
D4060212	• Mahogany Satin	750ml
D4060206	• Deep Mahogany Satin	750ml
D4060194	• Antique Pine Satin	750ml
D4060218	• Rosewood Satin	750ml
D4060224	• Teak Satin	750ml
D4060200	• Dark Oak Satin	750ml
D4060232	• Walnut Oak Satin	2.5 Ltr
D4060190	• Antique Oak Satin	2.5 Ltr
D4060214	• Mahogany Satin	2.5 Ltr
D4060208	• Deep Mahogany Satin	2.5 Ltr
D4060196	• Antique Pine Satin	2.5 Ltr
D4060220	• Rosewood Satin	2.5 Ltr
D4060226	• Teak Satin	2.5 Ltr
D4060202	• Dark Oak Satin	2.5 Ltr

**RONSEAL 5 YEAR WOODSTAIN**

A superior quality exterior woodstain specially formulated to waterproof and protect exterior wood and independently guaranteed to last for at least 5 years

- Superb 5 year performance independently guaranteed
- Protects, colours and finishes exterior wood
- Prevents cracking, peeling and blistering
- Durable finish
- No basecoats or primers
- Rainproof in 1 hour
- Brushes wash out in water

D4060258	• Mahogany	250ml
D4060252	• Deep Mahogany	250ml
D4060240	• Antique Pine	250ml
D4060246	• Dark Oak	250ml
D4060270	• Teak	250ml
D4060276	• Walnut	250ml
D4060264	• Rosewood	250ml
D4060260	• Mahogany	750ml
D4060254	• Deep Mahogany	750ml
D4060242	• Antique Pine	750ml
D4060248	• Dark Oak	750ml
D4060272	• Teak	750ml
D4060278	• Walnut	750ml
D4060266	• Rosewood	750ml
D4060262	• Mahogany	2.5 Ltr
D4060256	• Deep Mahogany	2.5 Ltr
D4060244	• Antique Pine	2.5 Ltr
D4060250	• Dark Oak	2.5 Ltr
D4060274	• Teak	2.5 Ltr
D4060280	• Walnut	2.5 Ltr
D4060268	• Rosewood	2.5 Ltr



Ronseal



**RONSEAL LAMINATE FLOOR SEAL**

The quick and easy way to revitalise worn laminate flooring. Satin finish.

- Quick drying
- Easy wipe on application
- Provides added protection

D4061350 - 1 Ltr

**RONSEAL ULTRA TOUGH MATTCOAT CLEAR MATT VARNISH**

Ultra tough polyurathane clear matt varnish, protects + highlights the true beauty of wood.

- Extremely tough + durable
- Heat, water + scratch resistant
- Long lasting protection

D4060014 - 250ml  
 D4060016 - 500 ml  
 D4060020 - 1 Ltr  
 D4060022 - 2.5 Ltr  
 D4060024 - 5 Ltr

**RONSEAL YACHT VARNISH**

A highly flexible exterior varnish providing superior protection for exterior wood

- Special flexible formula prevents cracking, peeling + blistering
- Highly water repellent
- Long lasting protection

D4060056 - Clear Gloss 250ml  
 D4060058 - Clear Gloss 500ml  
 D4060060 - Clear Gloss 1 Ltr  
 D4060062 - Clear Gloss 2.5 Ltr  
 D4060064 - Clear Satin 250ml  
 D4060066 - Clear Satin 500ml  
 D4060068 - Clear Satin 1 Ltr

**RONSEAL MULTI-PURPOSE WOOD TREATMENT**

An effective universal wood preserver that provides protection against wet rot and insect attack.

- Kills woodworm
- Kills wet rot
- Protects against insects and insect reinfestation
- Apply by brush, spray or dipping.

D4060102 - 1 Ltr  
 D4060104 - 2.5 Ltr  
 D4060106 - 5 Ltr

**RONSEAL ULTRA TOUGH SATINCOAT CLEAR SATIN VARNISH**

Ultra tough polyurathane clear satin varnish, protects + highlights the tru beauty of wood.

- Extremely tough & durable
- Heat, water & scratch resistant
- Long lasting protection

D4060026 - 250ml  
 D4060028 - 500ml  
 D4060032 - 1 Ltr  
 D4060034 - 2.5 Ltr  
 D4060036 - 5 Ltr

**RONSEAL DIAMOND HARD FLOOR VARNISH**

The ultimate protection for wooden floors

- Ronseals hardest ever floor varnish
- Maximum toughness + durability
- Quick drying, low labour and easy to apply
- Available in gloss + stain

D4060286 - Clear Gloss 750ml  
 D4060288 - Clear Satin 750ml  
 D4060290 - Clear Gloss 2.5 Ltr  
 D4060292 - Clear Satin 2.5 Ltr

**RONSEAL MULTI-PURPOSE WOOD PRESERVER**

Highly penetrative solvent based wood preserver providing long lasting protection to interior and exterior wood

- Penetrates deep to prevent rot & decay
- Colours & protects wood & joinery
- Longlasting waterproofing protection

D4060108 - Light Oak 1 Ltr  
 D4060110 - Dark Oak 1 Ltr  
 D4060112 - Green 1 Ltr  
 D4060114 - Clear 1 Ltr  
 D4060116 - Redwood 1 Ltr  
 D4060118 - Light Oak 2.5 Ltr  
 D4060120 - Dark Oak 2.5 Ltr  
 D4060122 - Green 2.5 Ltr  
 D4060124 - Clear 2.5 Ltr  
 D4060126 - Redwood 2.5 Ltr  
 D4060128 - Light Oak 5 Ltr  
 D4060130 - Dark Oak 5 Ltr  
 D4060132 - Green 5 Ltr  
 D4060134 - Clear 5 Ltr  
 D4060136 - Redwood 5 Ltr



**Rustins**



**MATT BLACK FINISHING PAINT**

Gives a very fine matt finish to woodwork and metal in exterior and interior situations.

- D1036630 - 125ml
- D1036631 - 250 ml
- D1036632 - 500 ml
- D1036634 - 1 Ltr
- D1036635 - 2.5 Ltr
- D1036636 - 5 Ltr

**SATIN BLACK**

Produces a smooth satin finish on wood and metal in exterior and interior situations.

- D1036831 - 250ml
- D1036832 - 500ml
- D1036834 - 1 Ltr
- D1036835 - 2.5 Ltr

**BLACK GLOSS PAINT**

High quality alkyd based paint suitable for interior and exterior use.

- D1036840 - 125ml
- D1036841 - 250ml
- D1036842 - 500ml
- D1036843 - 1 Ltr

**BLACKBOARD PAINT**

Fast drying black paint also ideal for photographic work.

- D1037030 - 125ml
- D1037031 - 250ml
- D1037032 - 500ml
- D1037034 - 1 Ltr
- D1037035 - 2.5 Ltr
- D1037036 - 5 Ltr

**ALUMINIUM PAINT**

Used both for its decorative effect and its waterproofing properties. Can be used as a metal primer or as a finishing paint for tanks and other metal structures. Heat resistant to approximately 100°C.

- D1037200 - 125ml
- D1037201 - 250ml
- D1037202 - 500ml
- D1037204 - 1 Ltr
- D1037205 - 2.5 Ltr
- D1037206 - 5 Ltr

**PRIMERS FOR WOOD**

White: An oil based primer for use when white or pastel shades of finishing paint are being applied. Lead free.

- D1038005 - 250ml
- D1038006 - 500ml
- D1038007 - 1 Ltr

Pink: For use on all wood

- D1038001 - 250ml
- D1038002 - 500ml
- D1038003 - 1 Ltr

Aluminium: Contains aluminium powder which provides better water resistance.

- D1037208 - 250ml
- D1037210 - 500ml

**STOVE BLACK (HEAT RESISTING)**

Used for painting grates but is also suitable for painting external timber and metal surfaces.

- D1037430 - 125ml
- D1037431 - 250ml
- D1037436 - 5 Ltr

**RADIATOR ENAMEL**

A heat resistant, quick drying, low odour brilliant white enamel that does not yellow with heat.

- D1037611 - 250ml
- D1037612 - 500ml

**BRICK & TILE PAINT**

Bonds exceptionally well to brick and tiles providing a durable and weather resistant matt finish. Ideal for interior and exterior use.

- D1037790 - Matt Red 250ml
- D1037792 - Matt Red 500ml
- D1037794 - Matt Red 1 Ltr

**STEP & TILE PAINT**

Gloss paint for stone & brick. Hard & durable.

- D1037800 - Gloss Red 250ml
- D1037801 - Gloss Red 500ml
- D1037802 - Gloss Red 1 Ltr
- D1037804 - Gloss Red 5 Ltr

**UNDERCOAT PAINT**

Lead free, high quality oil based undercoat.

- D1038010 - White 250ml
- D1038012 - White 500ml
- D1038014 - White 1 Ltr

**GLOSS PAINT**

A high quality alkyd based paint, suitable for interior and exterior use.

- D1038016 - Brilliant White 250ml
- D1038018 - Brilliant White 500ml
- D1038020 - Brilliant White 1 Ltr

**ACRYLIC FLOOR COATING**

- D1038210 - Gloss 1 Ltr
- D1038212 - Gloss 2.5 Ltr
- D1038214 - Gloss -5 Ltr
- D1038216 - Satin 1 Ltr
- D1038218 - Satin 2.5 Ltr
- D1038220 - Satin 5 Ltr

**PLASTIC FLOOR COATING**

- D1038222 - Gloss 1 Ltr
- D1038224 - Gloss 4 Ltr
- D1038224 - Satin 1 Ltr
- D1038228 - Satin 4 Ltr



## Rustins



### ACRYLIC VARNISH

For use on all interior woodwork and furniture. Fast drying, hard wearing, easy to apply, for all types of wood & cork.

- D1038230 - Clear Gloss 250ml
- D1038232 - Clear Gloss 500ml
- D1038234 - Clear Gloss 1 Ltr
- D1038236 - Clear Gloss 2.5 Ltr
- D1038238 - Clear Gloss 5 Ltr
- D1038240 - Clear Satin 250ml
- D1038241 - Clear Satin 500ml
- D1038242 - Clear Satin 1 Ltr
- D1038250 - Clear Matt 250ml
- D1038252 - Clear Matt 500ml
- D1038254 - Clear Matt 1 Ltr
- D1038256 - Clear Matt 2.5 Ltr
- D1038258 - Clear Matt 5 Ltr

### SHELLAC SANDING SEALER

A cloudy white Shellac solution used instead of grain filler on fine grained woods and as a sealer before waxing.

- D1038260 - 500ml
- D1038262 - 1 Ltr

### SHELLAC VARNISH

Used as gasket cement. Knotting and for sealing timber which has been treated with creosote and then requires painting.

- D1038266 - 1 Ltr
- D1038268 - 4 Ltr

### FRENCH POLISH

Used extensively on high quality furniture and for renovating old furniture that does not need stripping.

- D2000201 - 4 Ltr
- D2000202 - 2 Ltr
- D2000203 - 1 Ltr
- D2000204 - 500 ml
- D2000205 - 250ml
- D2000206 - 114ml

### GARNET POLISH

For use on mahogany or darkwoods

- D2000401 - 4 Ltr
- D2000402 - 1 Ltr

### GOLD PAINT

Made to the same formula as aluminium paint but using gold powder in place of aluminium powder.

- D2000403 - 57ml
- D2000404 - 125ml
- D2000405 - 250ml
- D2000406 - 1 Ltr

### BUTTON POLISH

Applied in the same way as french polish but gives a harder more orange colour finish.

- D2000601 - 4 Ltr
- D2000602 - 2 Ltr
- D2000603 - 1 Ltr
- D2000604 - 500ml
- D2000605 - 250ml
- D2000606 - 114ml

### LINSEED OIL RAW

Used for oiling cricket bats and by french polishers to lubricate the polishing rubber

- D2001001 - 4 Ltr
- D2001002 - 2 Ltr
- D2001003 - 500ml
- D2001004 - 250ml
- D2001005 - 114ml

### LINSEED OIL BOILED

Ideal for oiling bare wood, adding to paint and softening putty. Heat treated so that it dries quicker.

- D2000801 - 4 Ltr
- D2000802 - 2 Ltr
- D2000805 - 500ml
- D2000806 - 250ml
- D2000804 - 114ml



### TRANSPARENT POLISH

- D200120 - 250ml

### WHITE POLISH

French polish made with bleached white Shellac

- D2001201 - 4 Ltr
- D2001202 - 2 Ltr
- D2001203 - 1 Ltr
- D2001204 - 250ml
- D2001205 - 114ml

**Rustins**



**TEAK OIL**

A quick drying penetrating seal for teak, cedar and all bare woods. For exterior and interior woods

- D2001401 - 5 Ltr
- D2001402 - 1 Ltr
- D2001403 - 250ml
- D2001404 - 114ml
- D2001405 - 500ml

**CELLULOSE THINNER**

A blend of solvents for use with any make of Cellulose

- D2002001 - 5 Ltr
- D2002002 - 1 Ltr
- D2002003 - 500ml
- D2002004 - 250ml
- D2002005 - 114ml

**WOODSTOPPING**

Excellent for filling holes or cracks in wood as it does not shrink when drying

- D2002201 - 320g Natural
- D2002202 - 320g Oak
- D2002203 - 320g Mahogany
- D2002204 - 320g Teak

**EXTERIOR WOODSTOPPING**

A waterproof version for exterior woodwork

- D2002200 - 260g White

**DANISH OIL**

Oil finish suitable for all types of timber. Differs from teak oil in that contains ingredients preventing it drying to a gloss. Used on timber which has been heavily oiled.

- D2001602 - 1 Ltr
- D2001603 - 500ml
- D2001604 - 250ml

**GRAINFILLER**

A paste thinned with white spirit for use on wood before finishing. Prevents sinking of the finish.

- D2002301 - 230g Natural
- D2002302 - 230g Oak
- D2002303 - 230g Mahogany
- D2002304 - 230g Teak

**METHYLATED SPIRITS**

- D2002450 - 250ml
- D2002451 - 500ml
- D2002452 - 4 Ltr

**KNOTTING**

Used to paint over knots to prevent resinous material in them from dissolving solvents in paint.

- D2001801 - 4 Ltr
- D2001802 - 2 Ltr
- D2001803 - 1 Ltr
- D2001804 - 500ml
- D2001805 - 250ml
- D2001806 - 114ml

**WHITE KNOTTING**

Use as a knotting

- D2001798 - 4oz
- D2001799 - 250ml
- D2001800 - 1 Ltr

**FLEXTERIOR**

A flexible exterior satin wood finish with ultra violet & fungicide protection. Ideal for use on all new, planed, sawn, soft & hard woods. When correctly applied it will not peel, crack or blister.

- D2002605 - 1 Ltr Teak
- D2002608 - 1 Ltr Dark Oak
- D2002612 - 500ml Clear

**WOOD BLEACH**

Makes natural woods white or lighter in colour. Removes weather stains and other discolourations. Can only be used on bare timber.

- D2003002 - 4 Ltr Set A
- D2003003 - 4 Ltr Set B

**POLYURETHANE FLOOR SEALER**

A heavily bodied clear polyurethane giving a high gloss durable finish to wood and cork floors. Dries in approx 6 hours.

- D2003203 - 1 Ltr Clear Gloss
- D2003204 - 1 Ltr Clear Satin

**YACHT VARNISH**

Contains tung oil to give protection and long lasting durability on all exterior woodwork. When correctly applied will not flake or peel.

- D2003300 - 250ml
- D2003301 - 500ml
- D2003302 - 1 Ltr

**Rustins**



**POLYURETHANE VARNISH**

Hard & durable finish for all woodwork & cork.

Clear Gloss  
 D2003403 - 1 Ltr  
 D2003404 - 500ml

Clear Satin  
 D2003603 - 1 Ltr  
 D2003604 - 500ml

Clear Matt  
 D2003803 - 1 Ltr  
 D2003804 - 500ml

**SCRATCH COVER**

Will mask unsightly surface scratches. Made in 2 shades for light, medium & dark furniture.

D2004210 - 250ml Light  
 D2004211 - 250ml Dark

**SURFACE CLEANER**

A blend of powerful solvents which will remove accumulated wax and dirt from furniture without harming the original finish.

D2004213 - 250ml

**FINISH REVIVER**

Will restore the gloss and remove minor surface defects to finishes that have lost their lustre. Surface water & heat marks can also be removed.

D2004215 - 250ml

**LIQUID WAX**

Non-flammable & non toxic wax emulsion containing beeswax & Carnauba wax. Can be used safely on new & old furniture after cleaning off old wax with the surface cleaner.

D2004217 - 250ml

**PLASTIC WOOD**

A quick drying filler. Suitable for interior or exterior use. Can be cut, filed, drilled, sanded, planed, painted, stained or varnished. When dry it will take screws and nails.

D2004229 - 125ml Natural  
 D2004230 - 20ml Natural  
 D2004231 - 20ml White  
 D2004232 - 20ml Mahogany  
 D2004233 - 20ml Teak

**BRUSH CLEANER**

A special liquid which emulsifies oil paints & varnishes so that brushes can be washed completely clean with water.

D2004240 - 5 Ltr  
 D2004241 - 2.5 Ltr  
 D2004242 - 250ml

**BRUSH RESTORER**

Removes dried paints, varnishes and polyurathanes

D2004243 - 5 Litre  
 D2004244 - 2.5 Litre

**MDF QUICK DRYING SEALER CLEAR**

Can be varnished or painted for a perfect finish

D2004500 - 250ml  
 D2004502 - 500ml  
 D2004504 - 1 Ltr





## Nitromors

### NITROMORS MASTER CRAFTSMAN PAINT & VARNISH REMOVER



A fast and effective stripper which is tough on paint and varnish but kind to wood. For use on fine furniture, veneers and mouldings.

- D4000012 - 250ml
- D4000014 - 500ml
- D4000016 - 1 Ltr
- D4000018 - 2.5 Ltr
- D4000020 - 5 Ltr

### NITROMORS SPECIALIST VARNISH & LAQUER REMOVER



A fast and effective stripper which is tough on varnish but kind to wood. For removing polyurethane, shelliac and french polish.

- D4000022 - 250ml
- D4000024 - 500ml
- D4000026 - 1 Ltr
- D4000028 - 2.5 Ltr
- D4000030 - 5 Ltr

### NITROMORS TEXTURED PAINT REMOVER BIODEGRADABLE



A unique thick gel for use overhead on textured ceilings. Non-drip, ideal for large areas. Suitable for emulsions and masonry paints.

- D4000032 - 2.5 Ltr

### NITROMORS SUPERSTRIP PAINT & VARNISH REMOVER



A low odour, deep penetrating stripper which remains active for up to 24 hours.

- D4000034 - 400ml Brush Pack
- D4000036 - 2 Ltr

### NITROMORS ALL PURPOSE PAINT & VARNISH REMOVER



A fast and effective stripper which is tough on paint and varnish but kind to wood. For use on wood, metal and masonry.

- D4080000 - 250ml
- D4080002 - 500ml
- D4080004 - 1 Ltr
- D4080006 - 2.5 Ltr
- D4080008 - 5 Ltr
- D4080010 - 200 Ltr

### NITROMORS WOODSTAIN REMOVER



- D4000038 - 400ml Brush Pack

## Aquaseal



### AQUASEAL HIGH PERFORMANCE EXTERIOR WATERSEAL

An exterior water repellent product containing silicones suitable for use on all porous building surfaces, brick, stone, concrete, cement, building blocks, renderings, gypsum plaster, hardboard, wood and decorative wall coatings.

D4000000 - 5 Ltr

### AQUASEAL SOLVENT FREE ROOF WATERPROOFER

A waterbased emulsion for the treatment of asphalt, concrete, metal, roofing felt and other similar roof surfaces. Being a waterbased emulsion the product must be fully dry before it is resistant to rain.

D4000003 - 2.5 Ltr  
D4000004 - 1 Ltr

### AQUASEAL BLACK BITUMEN PAINT

A black bitumen paint which is completely waterproof and weatherproof. Suitable on corrugated iron sheets, stairways, fire escapes, storage and water tanks, metal gutters, down pipes, metal fences, railings and gates.

D4000402 - 5 Ltr  
D4000403 - 2.5 Ltr  
D4000404 - 1 Ltr

### AQUASEAL SELF ADHESIVE ROOF AND GUTTER REPAIR TAPE

A self-adhesive black tape used in the repair of cracked guttering. Can also be used for other gaps and cracks on roofs.

D4000801 - 100mm x 2.5m

### AQUASEAL INTERIOR DAMP STAIN BLOCK

A specially formulated damp proof treatment for interior surfaces of walls and ceilings. It can be applied to damp or dry surfaces.

D4000802 - 2.5 Ltr

### AQUASEAL BITUMEN ROOF REPAIR MASTIC

A mastic specifically prepared to seal cracks, holes and joints in roofs and gutters prior to the surfaces being coated by Aquaseal solvent free waterproofer

D4001002 - 5 Ltr  
D4001003 - 2.5 Ltr  
D4001004 - 1 Ltr

### AQUASEAL HYPRUFE DAMP PROOF LIQUID MEMBRANE

Aquaseal Hyprufe damp proof liquid membrane is a liquid applied between a bitumen/rubber latex damp proofer to provides a flexible damp and vapour proof seamless membrane for floors and walls.

D4001202 - 5 Ltr  
D4001203 - 2.5 Ltr

### AQUASEAL FAST DRYING ROOF WATERPROOFER

For use in the waterproofing of flat roofs, including felt, asphalt, concrete, metal, corrugated sheets. Being solvent based it will resist rain wash off soon after application.

D4001401 - 2.5 Ltr  
D4001402 - 5 Ltr

### AQUASEAL FIRMAFIX ADHESIVE

A cold applied bitumen adhesive. A tenacious adhesive for sticking roofing felt to concrete, asphalt, metal or bitumen.

D4002002 - 5 Ltr  
D4002003 - 2.5 Ltr  
D4002004 - 1 Ltr

### AQUASEAL HIGH PERFORMANCE ROOF GUTTER SEALANT

A solvent based high performance sealant for roofs/gutters. Generally used to repair cracks and gaps on roofs and guttering

D4003010 - 318ml



## Ruberoid & Laybond



### RUBEROID SYNTHAPRUFE

Synthaprufe is a high performance damp proofing emulsion for a wide range of applications. Provides a damp proof membrane for concrete, brick, skimmed brickwork, retaining walls and bridge abutments. Used on walls and floors but not suitable for roofing applications.

D4009911 - 2.5 Ltr  
D4009912 - 5 Ltr



### LAYBOND WEATHERBAND

Laybond Weatherband  
A self adhesive flashing for general repairs & sealing. Suitable for guttering, down pipes, roofs and various other uses.

10 Mtr Rolls  
D6002810 - 50mm wide  
D6002811 - 75mm wide  
D6002812 - 100mm wide  
D6002813 - 150mm wide  
D6002814 - 225mm wide  
D6002815 - 300mm wide



### LAYBOND SUPER PENETRATION PRIMER

Brush or spray applied to prime roofs before applying bituminous coatings

D6003602 - 1 Ltr

## Thompson's



### THOMPSON'S WATER SEAL

High performance decorative and protective finish. for wood and metal interior and exterior surfaces.

- A unique colourless universal waterproofing solution that creates a barrier against water for external use on brick, concrete, stone, wood and canvas.
- Penetrates deep into the substrate-providing better protection than surface coatings.
- The worlds leading clear waterproofer and protector
- Prevents moisture penetration whilst allowing the substrate to breathe.

D4061200 - 1 Ltr  
D4061202 - 2.5 Ltr  
D4061204 - 5 Ltr  
D4061210 - Spray Gun



### THOMPSON'S WATER SEAL ULTRA

Especially formulated to last much longer than standard waterproofer, it is the ultimate high performance transparent water repellent.

- Specially formulated for exterior brickwork and stone
- Can be applied on damp surfaces
- Quick drying
- Water sealing lasts four times longer than conventional clear waterproofer
- Only one coat required

D4061212 - 1 Ltr  
D4061214 - 2.5 Ltr  
D4061216 - 5 Ltr



### THOMPSON'S HIGH PERFORMANCE ROOF SEAL

Long lasting flexible coating designed to resist cracking during expansion and contraction.

- Waterproofs and protects flat roofs
- Outlasts conventional bitumen based coatings
- No primer required

D4061218 - Black 1 Ltr  
D4061220 - Grey 1 Ltr  
D4061222 - Black 2.5 Ltr  
D4061224 - Grey 2.5 Ltr  
D4061226 - Black 4 Ltr  
D4061228 - Grey 4 Ltr  
D4061230 - Black 7.5 Ltr

### THOMPSON'S SOLAR REFLECTIVE ROOF SEAL

Reduces heating absorption by up to 50% and designed to resist cracking during expansion and contraction.

- Waterproofs and protects flat roofs
- Outlasts conventional bitumen based coatings
- No primer required

D4061232 - White 4 Ltr

Waterproofing

## Thompson's



### THOMPSON'S PATIO SEAL

A durable clear sealer designed to protect and maintain most types of patio

- Quick drying - Patio ready to use 1 hour after application
- Resists dirt pick up and formation of fungal growth
- Protects most types of patio from staining and weather damage

D4061242 - Clear 1 Ltr  
 D4061244 - Clear 2.5 Ltr  
 D4061246 - Clear 5 Ltr

### THOMPSON'S EMERGENCY ROOF SEAL

Can be applied underwater, contains added fibres designed to resist cracking during expansion and contraction

- Waterproofs and protects flat roofs
- Outlasts conventional bitumen based coatings
- No primer required

D40612345 - Black 1 Ltr  
 D4061236 - Black 2.5 Ltr

### THOMPSON'S BLOCK PAVING SEAL

A highly durable clear penetrating sealer designed to protect and maintain block paved areas.

- Prevents penetration of oil and fuels
- Waterproofs to resist the formation of fungal growth
- Enhances colour of block paving

D4061248 - 5 Ltr

### THOMPSON'S PATIO AND PAVING CLEANER

Thompsons patio and paving cleaner is specially formulated to clean and remove moss and algae from patios, paths and paving.

- Kills and protects against fungal growth
- Easy, quick and safe to use
- Leaves paving clean and free from dirt and algae.

D4061238 - 2.5 Ltr  
 D4061240 - 5 Ltr

### THOMPSON'S STAIN BLOCKING DAMP SEAL

High performance interior coating that masks unsightly water stains and prevents patches of penetrating damp showing through and spoiling decorations.

- Can be applied to damp surfaces
- Hides unsightly water stains
- Suitable for use on plaster, cement and stone
- Enables trapped water to escape without stains re-appearing

D4061250 - 250ml  
 D4061252 - 750 ml  
 D4061254 - 2.5 Ltr

### THOMPSON'S OIL + DRIVE CLEANER

Specially formulated to remove stubborn oil, grease, petrol and diesel stains.

- Powerful cleaning action
- Removes stubborn oil and fuel stains
- Quick easy + effective

D4061268 - 1 Ltr  
 D4061270 - 2 Ltr

### THOMPSON'S NICOTINE COVER

Permanently conceals virtually all household problem stains which spoil décor

D4061356 - White 750ml

### THOMPSON'S UPVC RESTORER

Cleans, revives and whitens UPVC in one. Removes ingrained dirt without scratching the surface.

D4061358 - 480ml

### THOMPSON'S CONCRETE SEAL

A highly durable stain resistant clear seal designed to stabilise and protect all concrete surfaces.

- Hard wearing: Ideal for use on garage floors
- Stops dusting, no overcoat required
- Resists penetration of oil and fuel spills

D4061272 - 2.5 Ltr  
 D4061274 - 5 Ltr

### THOMPSON'S AEROSOLS

A range of 6 problem solving aerosols that can address a multitude of repairs.

D4061256 - Damp Seal 300ml  
 D4061258 - Roof + Gutter Repair 300ml  
 D4061260 - Moss + Mould Repair 300ml  
 D4061264 - Oil Spot Remover 300ml  
 D4061266 - Stain Block 300ml  
 D4061262 - Waterproofer and Protector 300ml

### THOMPSON'S DRIVE SEAL

A high performance coating specially designed to renew, waterproof and protect tarmac drives  
 Resists oil, grease and dirt stains  
 Waterproofs to resist the formation of fungal growth

- Quick drying - dry in 1 hour
- Re-use drive after 4 hours
- Refreshes old, discoloured tarmac and covers existing stains.

D4061276 - Black 5 Ltr

**Anglo**

**ANGLO EPOXY REPAIR MORTAR**



Granite Hard two part epoxy resin mortar for use where conventional material would fail. No primer required. very easy to mix and use.

Coverage: 1kg covers 0-12m<sup>2</sup> at 5mm thick

- D1024012 - 1 kg
- D1024014 - 5 kg

**ANGLO SPEED PATCH**



A fast setting polymer modified cementitious concrete repair mortar for horizontal surfaces.

Coverage: 10kg covers 0-5m<sup>2</sup> at 10mm thickness

- D1024020 - 10 kg
- D1024022 - 20 kg

**ANGLO EPOXY FLOOR PAINT**



An exceptionally tough water dispersible epoxy paint which cures to form a silk finish - ideal for most types of industrial environments and as it is virtually odourless it can be used in confined areas.

- D1024124 - 4 Ltr Mid-Grey
- D1024126 - 4 Ltr Tile Red

**ANGLO SPEED GROUT**



An easy to use, single pack grout for bolt fixing, hole filling etc.

Coverage: 1kg will fill approx 625cc

- D1024030 - 10 kg

**ANGLO CEMENT CLEANER/ETCHANT**



Acidic etchant for the removal of laitence and the preparation of concrete prior to painting, giving a good surface for bonding. It will also remove cement and mortar stains from brickwork, paving, stonework etc.

Coverage: Up to 4m<sup>2</sup> per litre

- D1024060 - 2.5 Ltr
- D1024062 - 5 Ltr

**ANGLO VERTI PATCH**



A lightweight epoxy resin repair mortar for repairing vertical concrete, render and stone surfaces

Coverage: 1.5kg covers 0-6m<sup>2</sup> at 5mm thickness

- D1024110 - 1.5 kg Grey
- D1024112 - 1.5 kg Stone
- D1024114 - 1.5 kg Grey
- D1024115 - 1.5 kg Stone

**ANGLO FLOOR PAINT**



Durable mid-gloss finish, fast drying and oil resistant, suitable for garages, light industrial floors, utility rooms etc.

Coverage: Up to 40m<sup>2</sup> per litre per coat (2 coats required)

- D1024084 - 5 Ltr Mid-Grey
- D1024086 - 5 Ltr Tile Red



**Anglo**

**MULTI PURPOSE DEGREASER**



A superb penetrating, emulsifying degreasant which removes oil and grease from concrete and masonry floors. It is also suitable for cleaning machinery.

Coverage: Up to 2m<sup>2</sup> per litre

- D1024050 - 1 Ltr
- D1024052 - 2.5 Ltr

**ANGLO SAFE T EPOXY**



A roller applied slip resistant version of floor paint. Pre-blended aggregate produces an attractive evenly textured finish

Coverage: Up to 30m<sup>2</sup> per 5 litre per coat

- D1024100 - Midgrey 5 Ltr
- D1024102 - Red 5 Ltr

**ANGLO TREADSAFE**



A three part epoxy resin compound containing special hard wearing particles that quickly provides a safe and attractive anti-slip floor surface. Suitable for concrete, metal, stone and timber.

Coverage: 5m<sup>2</sup> per pack (only one coat required)

- D1024000 - 5m<sup>2</sup> Pack Black
- D1024001 - 5m<sup>2</sup> Pack Buff
- D1024002 - 5m<sup>2</sup> Pack Terracotta
- D1024003 - 5m<sup>2</sup> Pack Mid grey
- D1024004 - 5m<sup>2</sup> Pack Tile red
- D1024005 - 5m<sup>2</sup> Pack Blue
- D1024006 - 5m<sup>2</sup> Pack Green

**ANGLO ROOF REPAIR COMPOUND**



Exceptionally thick, fibre reinforced, brushable bitumen compound for use on all types of roof including felt, bitumen, asbestos, tiles and gutters etc.

Coverage: Up to 1m<sup>2</sup> per kg

- D1024040 - 5kg

**ANGLO MULTI PURPOSE SEALER**



A penetrative, water dispersed acrylic sealer that seals and hardens concrete surfaces to prevent dusting and provide a more easily cleaned surface. Ideal for most industrial floors including warehouses and machine shops.

Coverage: 30m<sup>2</sup> per 5 litre (only one coat required)

- D1024070 - 5 Ltr Clear

**ANGLO ANTI-SLIP TAPE**



Instant anti-slip surfaces for steps, ramps, floors, vehicles, boats, decks etc.

Roll size: 18m x 50mm approx

- D1024140 - Black
- D1024142 - Yellow
- D1024144 - Black/Yellow Hazard

**ANGLO ANTI-SLIP PRIMER**

for use in conjunction with anti-slip tape. Improves adhesion particularly on porous surfaces

- D1024160 - 500ml

## N & C Paint Brushes

### N & C PROFESSIONAL

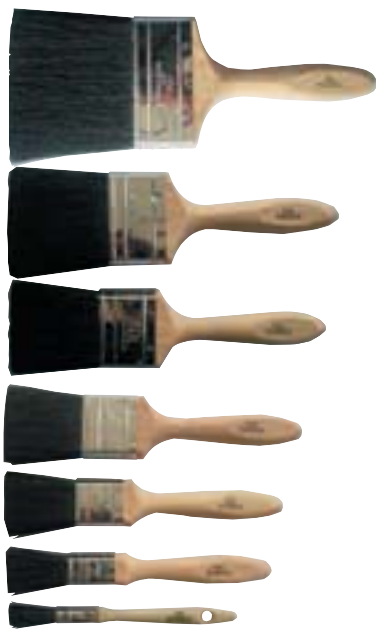

A high quality brush for the professional user, featuring premium quality bristles, a sealed beavertail wood handle and stainless steel ferrule.

- D8023020 - 25mm
- D8023022 - 37mm
- D8023024 - 50mm
- D8023026 - 64mm
- D8023028 - 75mm
- D8023030 - 100mm

### N & C WALL BRUSH

A high quality professional wall brush made of pure grey bristle with a 25mm thick copper ferrule and clear polished laminate wood handle.

- D8021001 - 100mm
- D8021002 - 125mm
- D8021003 - 150mm
- D8021004 - 175mm

### N & C PAPER HANGERS BRUSH

Top quality brush for the tradesman

- D8023600 - 9"

### CREOSOTE BRUSH



- D8021800 - 100 x 40 mm

### N & C CONTRACTOR

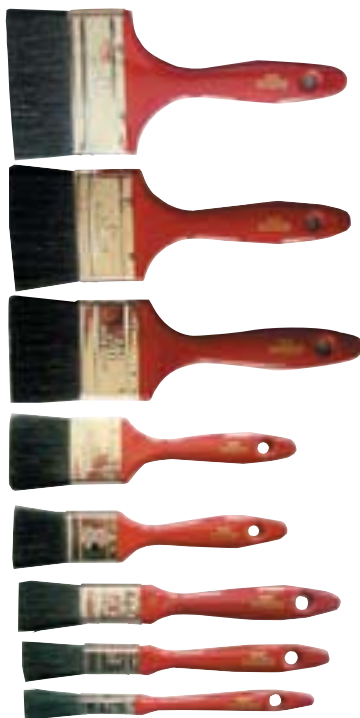

A medium quality brush for the tradesmen, ideal for site work. Made with pure black bristle with a maroon coloured beavertail handle.

- D8023000 - 12mm
- D8023016 - 19mm
- D8023018 - 25mm
- D8023006 - 37mm
- D8023008 - 50mm
- D8023010 - 64mm
- D8023012 - 75mm
- D8023014 - 100mm

### N & C FITCH BRUSH



Round, flat & slant cut fitches are made with pure white bristle

#### ROUND

- D8023201 - Size 2
- D8023202 - Size 4
- D8023203 - Size 6
- D8023204 - Size 8
- D8023205 - Size 10
- D8023206 - Size 12
- D8023207 - Set of 4 Containing, 4.6.8.10

#### FLAT

- D8023300 - Size 2
- D8023301 - Size 4
- D8023302 - Size 6
- D8023303 - Size 8
- D8023304 - Size 10
- D8023305 - Size 12
- D8023306 - Set of 4 Containing 4.6.8.10

#### SLANT CUT

- D8023001 - 1/4"
- D8023002 - 1/2"
- D8023003 - 3/4"
- D8023004 - 1"

### HAMILTON PERFECTION PREMIUM PERFORMANCE



This premium brush has satin tipped bristles for a perfectly smooth even finish, and a stainless steel ferrule.

- D8020601 - 12mm
- D8020602 - 19mm
- D8020603 - 25mm
- D8020604 - 37mm
- D8020605 - 50mm
- D8020606 - 64mm
- D8020607 - 75mm
- D8020608 - 100mm

### JAMB DUSTERS



- D8022000 - 100mm

### RADIATOR BRUSHES



Two styles of radiator brushes are available. The R series are of the flag type with a normal paintbrush head set at 90° to a wire handle. The N series are of dogleg construction with a long plastic handle.

#### R Series

- D8022601 - 25mm
- D8022602 - 37mm
- D8022603 - 50mm

#### N Series

- D8022801 - 25mm
- D8022802 - 37mm
- D8022803 - 50mm

# Brushes & Rollers



**N & C Paint Brushes**

**WIRE BRUSHES**



Well fitted steel wire

- D8023800 - 4 Row Plain
- D8024000 - 4 Row with 50mm Scraper

**PAINT ROLLER SLEEVES**



Extra long pile 1 1/4"  
For use on very rough surfaces  
1 3/4" Core Size

- D8024800 - 7"
- D8024801 - 9"

**PROFESSIONAL PLUS 10" STICK SYSTEM ROLLER SLEEVE REFILLS**



Masonry refill

- D8025510 - 10"

**LONG HANDLE TAR BRUSH**



- D8024200 - 2" Dia with 4'0" Handle

**LONG PILE IDEAL FOR EMULSION PAINTS**



1 3/4" Core Size

- D8025001 - 7"
- D8025002 - 9"

**PROFESSIONAL RAINBOW REFILL**



Offers high paint loading capacity for work on most surfaces

- D8025512 - 10"

**SHORT HANDLE TAR BRUSH**



- D8024201 - 2" Dia with Short Handle

**SHORT PILE IDEAL FOR GLOSS OR EMULSION PAINTS**



1 3/4" Core Size

- D8025202 - 7"

**N & C 9" PAINT ROLLER TRAY SET**



**PRO-FINISH PAINT ROLLER CAGE FRAME**

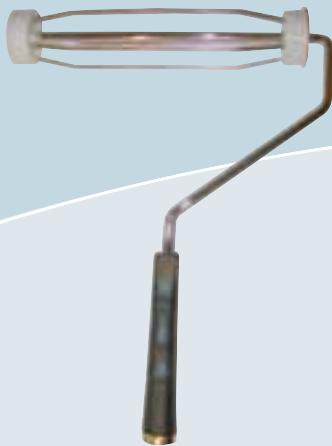

A plastic handled roller for the tradesmen 1 3/4" Core Size

- D8024710 - 7"
- D8024712 - 9"

**R TYPE SYNTHETIC IDEAL FOR GLOSS PAINTS**

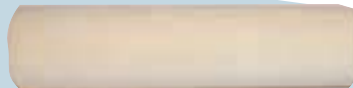

1 3/4" Core Size

- D8025401 - 7"
- D8025402 - 9"

**PROFESSIONAL PLUS 10" STICK SYSTEM ROLLER FRAME**

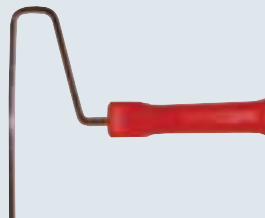

Allows easy refill changes whilst continuing to provide a secure grip

- D8024714 - 10"

Ideal for site work

- D8025602 - 9"

Soft Grip Contractor Tools



D9900116 - Contractor Soft Grip Stripping Knife 3"



D9900130 - Wallpaper Seam Roller



D9900126 - Contractor Soft Grip Stripping Knife 2"



D9900132 - Combination Shave Hook



D9900120 - Contractor Soft Grip Stripping Knife 1"



D9900134 - Triangle Shave Hook



D9900106 - Contractor Soft Grip Ultra Heavy Puty Scraper 4"



D9900102 - Contractor Soft Grip 5 in 1 Tool



D9900100 - Contractor Soft Grip Putty Knife

Decorating Tools

## Brush Mate

A wet paint brush care and storage system designed for use with oil based paints. Brush mate keeps wet brushes soft and pliable ready for instant use without cleaning. Available in two types for trade and D.I.Y. usage.

### BRUSH MATE TRADE 20



- Holds up to 20 brushes
- Supplied with 250ml of fluid and drip mat
- Steel carrying handle
- Stable design for non drip transportation

D8019950

### BRUSH MATE TRADE 4 PLUS



- Holds up to 4 brushes
- Impregnated vapour mate pad (no fluid required)
- Tough nylon construction

D8010052

## Brush Mate Accessories

- D8019954 • Trade 4 Plus Vapour Mate Pad
- D8019956 • Trade 20 Roller Plus
- D8019958 • Trade 20 Fluid 250ml
- D8019960 • Trade 20 Replacement Drip Mat
- D8019962 • Trade 20 Vapouriser panel
- D8019964 • Brush Mate Brush Clips (Pack of 4)

### PAINT KETTLES



D8018200 • 1 Ltr  
D8018210 • 2.5 Ltr

### PAINT SCUTTLES



D8026410 • 9 Ltr  
D8026412 • 15 Ltr

### WHITE SPIRIT



D8015001 • 2 Ltr  
D8015002 • 500ml Odour Free

**Decorating Sundries**

**DUST SHEETS  
BEST QUALITY TWILL**



- D8017201 - 18' x 12'
- D8017202 - 12' x 12'
- D8017203 - 12' x 9'
- D8017204 - 24' x 3'

**DOUBLE GUARD PAPER AND  
PLASTIC COMBINATION DUST  
SHEET**



D8017615 - 12' x 9'

**GAFFA TAPE**



50 metre roll

- D8018610 - Silver 50mm
- D8018611 - Black 50mm

**DUST SHEETS  
STITCH BONDED RAYON**



- D8017401 - 12' x 12'
- D8017402 - 12' x 9'

**STRING**



3 ply Sisal Twine

D8017800 - 200m

**STIKATAK DOUBLE SIDED  
HEAVY DUTY CLOTH TAPE**



50mm Wide

- D8018652 - 50m roll
- D8018654 - 5m roll

**DUST SHEETS  
POLYTHENE**



- D8017601 - 12' x 6'
- D8017602 - 12' x 9'
- D8017603 - 12' x 12'
- D8017604 - 15' x 12'
- D8017605 - 18' x 12'

**HEAVY DUTY 3 GALLON  
BLACK BUILDERS BUCKET**



D8018402

**STIKATAK DOUBLE SIDED  
HI TAK TAPE**



50mm Wide

D8018660 - 5m roll

**DUST SHEETS  
ATLAS WATER REPELLENT  
DUST SHEET**



D8017611 - 12' x 9'

**MASKING TAPE**



Best Quality Twill 50 metre roll

- D8018601 - 12mm Wide
- D8018602 - 18mm Wide
- D8018603 - 25mm Wide
- D8018604 - 36mm Wide
- D8018605 - 50mm Wide
- D8018606 - 75mm Wide
- D8018607 - 100mm Wide

**STIKATAK SINGLE SIDED  
WATERPROOF CLOTH TAPE**



50mm Wide

- D8018662 - 4.5m roll
- D8018656 - 50m roll

Decorating Sundries

**Decorating Sundries**

**STIKATAK DOUBLE SIDED ANTI PLAS TAPE**



50mm Wide

D8018658 - 5m Roll  
D8018664 - 50m Roll

**POLYTHENE JOINTING TAPE**

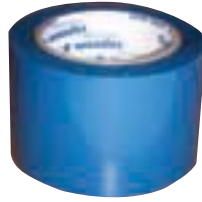

D8018800 - 75mm x 33m Blue

**BLACK REFUSE SACKS 50MM**



D8018902 - 18"x29"x34"  
(200 Per Box)

**UNIVERSAL TARPAULIN WATERPROOF SHEETS**



Eyeletted at metre intervals on all sides

D8017150 - 16' x 20'  
D8017152 - 30' x 18'  
D8017154 - 36' x 24'

**PARCEL PACKAGING TAPE 48MM**



D8018700 - 66m Roll Brown

**POLYTHENE BUILDING FILM**

Medium Duty (8 kilo)  
D8018801 - 4m x 50m

Heavy Duty (8 kilo)  
D80118802 - 4m x 25m

**N & C HEAVY DUTY BUILDERS BAG**



**GENERAL PURPOSE POLYTHENE**

800 Gauge  
D8018803 - 4m x 25m

Suitable for rubble. Ideal for site clearance

D8018900

**Wooden Step Ladders**



D8001972 - Domestic 3 Tread Stepladder inc. Platform

D8001980 - Light Duty Builders 6 Tread Step Ladder

D8001982 - Light Duty Builders 8 Tread Step Ladder

D8001984 - Light Duty Builders 10 Tread Step Ladder





## Lining and Woodchip Paper



Lining paper produces a stable base on walls and ceilings for overhanging other wallcoverings, and provides an ideal surface for emulsion painting and paint effects.

Woodchip is an excellent general decorating material producing a decorative and durable surface when over painted with emulsion paints.

- D8030401 - Lining 480 Gauge
- D8030402 - Lining 600 Gauge
- D8030403 - Lining 800 Gauge
- D8030404 - Lining 1000 Gauge
- D8030405 - Lining 1200 Gauge
- D8030600 - Woodchip Fine
- D8030601 - Woodchip Medium
- D8030602 - Woodchip Coarse

### SOLVITE OVERLAP & BORDER ADHESIVE



Improved formulation for overlapping seams, borders and wallpaper repairs

- D6010350 - Standard Tub

### SOLVITE WALLPAPER ADHESIVE



For all wallpapers including heavy embossed, washables, vinyls and blown vinyls.

- D6502010 - Retail Pack 5 Roll
- D6502040 - Decorators Pack 20 Roll

## Sandpaper and Glasspaper

### REDSTONE ALUMINIUM OXIDE PAPER

A range of heavy duty Industrial Quality Aluminium oxide paper for use when preparing paint & woodwork for decoration. Can be used on paint, plaster, fillers, particle boards and softwoods.

#### ALUMINIUM OXIDE YELLOW

150gm Weight superior paper backing & supplied on 50 mtr rolls.

- D8010602 - P240 Grit
- D8010604 - P180 Grit
- D8010606 - P150 Grit
- D8010608 - P120 Grit
- D8010610 - P100 Grit
- D8010612 - P 80 Grit
- D8010614 - P 60 Grit
- D8010616 - P 40 Grit

#### ALUMINIUM OXIDE GREEN

220gm Weight superior paper backing supplied on 50mtr rolls

- D8010618 - P240 Grit
- D8010620 - P180 Grit
- D8010622 - P150 Grit
- D8010624 - P120 Grit
- D8010626 - P100 Grit
- D8010628 - P 80 Grit
- D8010630 - P 60 Grit
- D8010632 - P 40 Grit
- D8010634 - P 36 Grit

#### ALUMINIUM OXIDE GREEN

Supplies on 10mtr Rolls  
D801660 P240 Grit

- D8010662 - P180 Grit
- D8010664 - P150 Grit
- D8010666 - P100 Grit
- D8010668 - P 36 Grit

### ALUMINIUM OXIDE RED

220gm Weight superior paper backing supplied on 50 mtr rolls

- D8010636 - P240 Grit
- D8010638 - P180 Grit
- D8010640 - P150 Grit
- D8010642 - P120 Grit
- D8010644 - P100 Grit
- D8010646 - P80 Grit
- D8010648 - P60 Grit
- D8010650 - P40 Grit

### ALUMINIUM OXIDE RED

Supplied on 10mtr rolls

- D8010674 - P150 Grit
- D8010678 - P100 Grit

### REDSTONE SILICON CARBIDE GREY

An industrial quality finishing abrasive. Can be used wet & dry to sand wood, metal, plastics, lacquers & paint.

100gm Weight superior paper backing supplied on 50mtr rolls

- D8010652 - P400 Grit
- D8010654 - P320 Grit
- D8010656 - P240 Grit
- D8010658 - P180 Grit

### REDSTONE CABINET GLASSPAPER

Glasspaper for the preparation of wood, painted plaster surfaces etc. Supplied in single sheet size 280 x 230mm

- D8010805 - Grade F2 Fine
- D8010806 - Grade M2 Medium
- D8010807 - Grade S2 Coarse



## Tetrion



# Fillers & Adhesives

### TETRION READY MIXED ALL PURPOSE FILLER

An easy to use, versatile, ready mixed filler suitable for large cracks. Developed for interior and exterior use

- Water resistant
- Can be drilled and tapped
- Tough, smooth and permanent
- Resistant to vibration cracking and shrinking
- Super white formulation

D7010000 - 330gm Tube  
 D7010010 - 600gm Tub  
 D7010020 - 1kg Tub  
 D7010030 - 2kg Tub  
 D7010040 - 5kg Tub

### TETRION SMART FILLER

- Ready Mixed, suitable for large or fine cracks
- Will not slump, sag or shrink
- Brilliant white formulation  
 Can be over painted or wallpapered in 15 minutes
- Screw or nail straight into filler
- At least 10 times stronger than conventional lightweight fillers

D7010130 - 500ml  
 D7010135 - 1 Ltr

### TETRION WOOD FILLER AND ADHESIVE

An all purpose filler for the repair and renovation of natural timbers and manufactured boards as well as for pattern making. It can be sawn, drilled, screwed, sanded, planed, carved and painted. Resistant to sea water, oil, petrol, atmospheric chemicals and frost. Acts as a powerful wood to wood or wood to metal adhesive.

D7010250 - 400mg Tin  
 D7010260 - 1.5kg Tin

### TETRION READY MIXED FINE SURFACE FILLER

Ideal for filling fine cracks, nicks or chips in wood and plaster. Gives a super smooth finish and only needs light sanding before painting.

- Ideal for most building materials
- For interior and exterior use.

D7010060 - 600gm  
 D7010070 - 1kg

### TETRION ALL PURPOSE FILLER POWDER

Developed to be versatile, tough and water-resistant. For interior and exterior use. Seals, bonds and fills most household materials including plaster, wood, stone, concrete, glass, metal and brickwork.

D7010150 - 500gm Carton  
 D7010160 - 1.5kg Carton  
 D7010170 - 3kg Carton  
 D7010180 - 5kg Carton  
 D7010190 - 10kg Sack

### TETRION RAPID SET FILLER POWDER

Formulated to set harder than concrete and is completely waterproof. It will set rock hard in 1 hour in ambient temperatures.

- Sets 5 times harder than concrete
- Ideal for heavy duty repairs
- Anchors bolts, pins and posts into floors + walls

D7010310 - 2kg

### TETRION READY MIXED FLEXIBLE WOOD FILLER

Easy to use, ready mixed for interior and exterior use. Bonds strongly to wood and leaves a water resistant, super smooth finish which can be stained.

- Easy to sand
- Shrink resistant
- Suitable for wood filling repairs to doors, skirting boards, floor boards, window frames, nail holes etc.

D7010090 - 330gm Tube  
 D7010140 - 600gsm Tub

### TETRION MULTI-PURPOSE INTERIOR FILLER-POWDER

Specifically made for inside use and provides a repair that is particularly compatible with plastered surfaces which are to be painted.

D7010200 - 500gm Carton  
 D7010210 - 1.5kg Carton  
 D7010220 - 5kg Sack  
 D7010230 - 10kg Sack



### TETRION STONE FILLER AND ADHESIVE

A two part fast setting, waterproof filler for the repair and restoration of natural and ornamental stone and ceramic. It can be used for filling holes, cracks and joints and when used as an adhesive, provides a fast and powerful bond.

- Interior and exterior use
- Sets within 30 minutes
- Water and weather proof

D7010350 - Black 1 Ltr  
 D7010352 - White 1 Ltr  
 D7010354 - Clear 1 Ltr  
 D7010356 - Straw 1 Ltr

### SURESEAL ULTRA LIGHT FILLER

An ultralight filler for large or small cracks in concrete, masonry, plaster and wood. The filler is non slump and therefore ideal for ceilings, non shrinking, sandable, paintable & flexible.

D8007805 - 1 Ltr

**Spontex**



**MANGERS SUGAR SOAP**

A highly effective cleaner for the preparation of surfaces prior to decorating.

- D8009004 - 5 Ltr Mix
- D8009005 - 10 Ltr Mix
- D8009006 - 30 Ltr Mix
- D8008802 - 50 Ltr Mix

**SPONTEX 40 ALL PURPOSE CLOTHS**

D8012000 - Roll Weight 226m2

**SPONTEX BATHROOM SPONGE SCOURER**

D8012010

**SPONTEX DRIPSTRIP**

The amazing dripstrip is an ingenious solution to condensation problems. Left along window sills it soaks up puddles protecting walls & paintwork and prevents stains. When wet simply wring out and re-lay. Can be cut to ensure snug tidy fit.

D8012020 - 6 mtr Roll

**SPONTEX EASY SPONGE SCOURER**

D8012030 - Pack of 2

**SPONTEX HEAVY DUTY SPONGE**

100% Natural cellulose sponge. Ideal for tough clean up jobs. Super absorbent it can hold up to 20 times its own weight in water.

D8012040 - Each

**SPONTEX HYGENIC HANDY SPONGE**

Contains Tricolosan an anti bacterial agent to reduce the growth of bacteria.

D8012050

**SPONTEX HYPERMOP**

Dries and cleans quicker than traditional mops and will clean right into corners.

- D8012060 - Hydromop Complete
- D8012070 - Hydromop Refill

**SPONTEX ANTI BACTERIAL WIPES**

Lemon fresh anti bacterial wipes  
D8012080 - Pack of 30

**SPONTEX GREEN SCOURER PADS**

Durable and versatile pads ideal for the removal of stubborn burnt on stains.

- D8012090 - Pack of 10
- D8012100 - Pack of 2

**SPONTEX TOUGH SCOURERS**

Used to shift the toughest burnt on food and grease without effort.

D8012110 - Pack of 3

**SPONTEX DECORATORS SPONGE**

Standard size sponge which is extra absorbent and versatile.

D8013001

Decorating Sundries



**Oils and Cleaning Agents**

**WD-40**



An outstanding lubricant, penetrating oil, rust preventative, moisture repellent, metal cleaner & silicone spray.

- D8016401 - 5 Ltr
- D8016402 - 400ml
- D8016403 - 200ml
- D8016404 - 100ml
- D8016405 - 600ml
- D8016406 - Cleaning Cloth (Pack of 3)

**3 IN 1 MULTI PURPOSE OIL**



It lubricates, cleans & prevents rust, its precise, easy to use drip spout enables precise lubrication with no overspray.

- D8016202 - 100ml
- D8016204 - 200ml
- D8017214 - 125ml Telespout

**LAVA CLEANERS**



The Lava range of heavy duty hand cleaning products are available in various formats to meet all of the needs of anyone who gets their hands dirty.

- D8011100 - Lava Heavy Duty Hand Cleaner 150G Bar
- D8011101 - Lava Heavy Duty Hand Cleaner 225ml Liquid
- D8011102 - Lava Heavy Duty Hand Cleaner 500ml Liquid
- D8011104 - Lava Heavy Duty Hand Cleaner 975ml Liquid
- D8011105 - Lava Heavy Duty Hand Towels 10 Pack

**DISCLEAN BRICK CLEANER**



**CLEANER**  
Cleans cement mortar stains from brickwork as well as limescale and algae.

**HYDROCHLORIC ACID SPIRITS OF SALTS**



A Highly effective stain remover. Caution needed when using.

- D8015201 - 5 Ltr
- D8015199 - 15 Ltr

**DISINFECTANTS & WASHING UP LIQUID AND INDUSTRIAL BLEACH**



D8015302 Industrial Black Disinfectant



D8015400 Industrial Pine Disinfectant



D8015600 Industrial Detergent Washing Up Liquid



D8015800 Industrial Bleach

## H G Hagesan

HG Hagesan manufacture over 170 products that clean, protect and beautify tiles, flagstones, natural stone, cotto, marble, laminated wood, parquet, vinyl, linoleum, textiles, leather, furniture, carpet, upholstery, kitchens, bathrooms and kitchens. We have shown some of the more common treatments but if you have a particular surface to clean or protect please contact a member of our sales team who will be pleased to advise.



### HG EXTRA

Safely removes cement film from tiles and flagstones without affecting the joints. Also removes limescale and rust stains.

D8050010 - 1 Ltr  
D8050012 - 5 Ltr

### HG IMPREGNATOR

Helps to prevent stains on unglazed porous tiles and flagstones, does not contain silicones and can be used inside and outside.

D8053010 - 1 Ltr  
D8053012 - 5 Ltr

### HG GOLV POLISH

This unique removable polish for floor and wall tiles gives a fabulous satin gloss and protects against stains and stubborn soiling at the same time.

D8052010 - 1 Ltr  
D8052012 - 5 Ltr

### HG SUPERFLOOR

Cleans, maintains and protects with a gloss in one application. For use on all glazed and unglazed tiles and floors treat with HG 'Golv Polish'

D8057010 - 1 Ltr  
D8057012 - 5 Ltr

### HG QUICK

A special cleaner for lightly and heavily soiled porcelain floor tiles and stoneware. Also suitable for other unglazed floor tiles.

D8052014 - 1 Ltr  
D8052016 - 5 Ltr

### HG REMOVER

For the removal of stubborn dirt, old wax coatings and worn polish such as HG 'Golv Polish' on tiled floors.

D8051010 - 1 Ltr  
D8051012 - 5 Ltr

### HG GROUT CLEANER

A deep and thorough cleaner, which restores all joints between wall and floor tiles.

D6055010 - 0.5 Ltr

### HG SPOT STAIN REMOVER

Removes deep and stubborn stains on unglazed flooring, concrete, natural stone and porous grout joints.

D8054010 - 0.5 Ltr

### HG MARBLE CEMENT AND LIME FILM REMOVER

Special cleaner for removing cement and lime without any damage to the marble.

D8070010 - 1 Ltr  
D8070012 - 5 Ltr

### HG MARBLE IMPREGNATOR

Invisibly helps to prevent dirt and stains from penetrating deep into porous marble. Surfaces retain their natural appearance and are able to breath.

D8072010 - 1 Ltr  
D8072012 - 5 Ltr

### HG LAMINATE WASH AND SHINE

This glossy cleaner helps to prevent dulling by adding a shine to laminated surfaces everytime you clean.

D8098000 - 1 Ltr

### HG VINYL AND LINOLEUM CLEAN AND SHINE

Cleans, protects and takes care of vinyl and linoleum in one treatment. Dries without streaks and leaves shiny layer.

D8097000 - 1 Ltr

### HG CARPET AND UPHOLSTERY CLEANER

Cleans deeply, thoroughly and fast. Has a dirt repellent action after use. Suitable for manual cleaning as well as all cleaning machine.

D8097022 - 1 Ltr

### HG DESCALER

A fast acting descaler for heating elements, kettles, coffee makers, hot water dispensers, washing and dishwashing machines.

D8065010 - 0.5 Ltr

### HG HAGESAN BLUE

A powerful yet safe product to remove lime scale, rust stains and copper oxide. Specially formulated to recondition chrome, stainless steel, tiles, glass and plastic.

D8060010 - 0.5 Ltr  
D8060012 - 1 Ltr  
D8060014 - 5 Ltr



**Brooms**

All brooms shown are supplied complete with handle

**12" ROUND STOCK BROOM**



D8028006 - Bassine  
D8028008 - Soft (coco)

**GARDEN BROOM**



D8027801 - 11" Red PVC

**HOUSEHOLD PLASTIC SWEEPERS**



D8028002 - Soft  
D8028001 - Stiff

**PLATFORM BROOM WITH STAY**

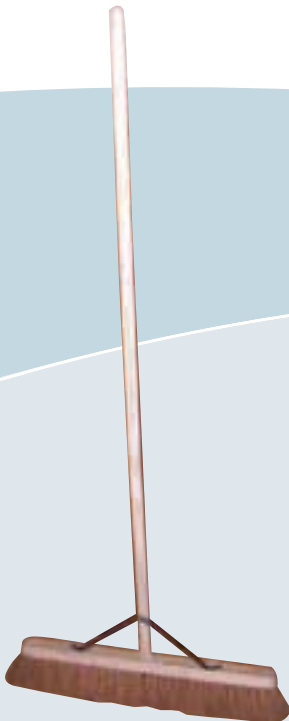

D8027601 - 18" Bassine  
D8027602 - 24" Bassine  
D8027401 - 18" Soft (Coco)  
D8027400 - 24" Soft (Coco)

**YARD BROOM**

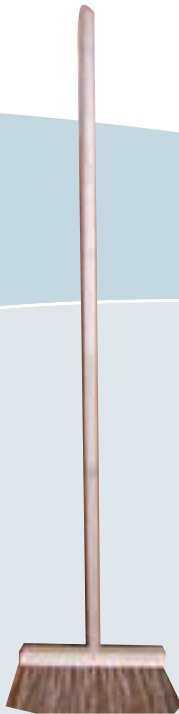

D8028010 - 13" Bassine/Cane

**WOODEN BROOM HANDLES**

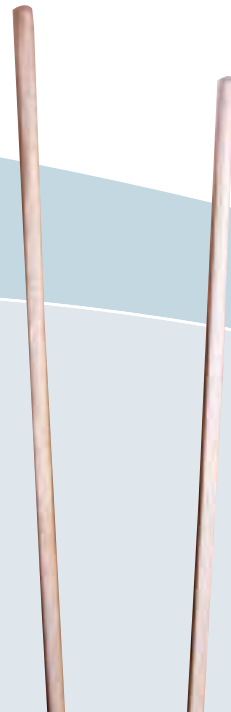

D8029001 - 48" x 15/16"  
D8029002 - 48" x 1 1/8"  
D8029003 - 60" x 1 1/8"

**Cleaning Products**

**9" DECK SCRUB**

D8028600

**10" CHURN BRUSH CURVED STOCK**



(Dandy Brush)  
D8028400

**RUBBER FLOOR SQUEEGEE HEAD**



D8028801 - 18"  
D8028802 - 24"

**LIGHT WEIGHT STAINLESS STEEL SQUEEGEE WITH STREAK FREE RUBBER BLADE**



D8001920 - 12"  
D8001950 - Replacement Blade

**GOLDEN GLOVE WINDOW SCRUBBER**



For use before squeegeeing.  
Machine washable cover  
D8001952 - 10"  
D8001960 - Replacement Cover

**GENERAL PURPOSE ACRYLIC SQUEEGEE**

D8001970 - 6"

**SCRUBBER/SQUEEGEE TWIN PACK CONSISTING OF**



1 x 12" Squeegee x 1 10" window scrubber

D8001968

**SQUEEGEE OFF LIQUID**



Easy Glide Formula  
D8001974

**DUSTPAN & BRUSH SET**

D8029600 - Soft Bristle  
D8017222 - Stiff Bristle

**PURE YARN MOP & HANDLE METAL SOCKET**



D8029401 Size 10  
D8029402 - Size 12  
D8029403 Size 14

**PURE YARN MOP HEAD METAL SOCKET**



D8029398 Size 10  
D8029400 Size 12  
D8029399 Size 14

**BIG INDUSTRIAL WIPES**



D8013805 - 80 Pack

Decorating Sundries

**Dow Corning**



**DOW CORNING 794 PLASTIC & GLASS SILICONE SEALANT.**

A single component clear neutral corning silicone sealant, suitable for glazing applications that utilise polycarbonate sheeting and for perimeter pointing of door & window frames.

D6009028 - Neutral Clear 310ml

**DOW CORNING FIRE STOP 400 INTUMESCENT ACRYLIC SEALANT**

For internal perimeter pointing around door and window frames and joints where fire rated partition sections meet.

D6009005 - White 380ml

**DOW CORNING 781 ACETOXY SILICONE SEALANT**

A single component, ready to use, high modulus silicone sealant. Suitable for glazing applications weathersealing of sheet cladding, curtain walls, draught proofing and general internal sealing.

D6009020 - White 310ml  
 D6009022 - Clear 310ml  
 D6009016 - Grey 310ml  
 D6009018 - Aluminium 310ml  
 D6009026 - Brown 310ml  
 D6009024 - Black 310ml

**DOW CORNING 796 PVC-U Wood & ALUMINIUM SILICONE SEALANT**

A single component, low modulus silicone sealant specifically developed for use with PVC-U

D6009030 - White 310ml

**DOW CORNING FIRESTOP 700 SILICONE SEALANT**

For the sealing of expansion joints and pipe and cable penetrations in fire rated structures.

D6009002 - White 310ml  
 D6009003 - Grey 310ml  
 D6009004 - Black 310ml

**DOW CORNING 785 SANITARY SILICONE SEALANT**

A single component, ready to use, high modulus silicone sealant suitable for sealing around sanitary fittings to give a water resistant hygienic seal.

D6009120 - White 310ml  
 D6009122 - Clear 310ml

**DOW CORNING 797 WEATHER-PROOFING SILICONE SEALANT**

A low modulus one-part silicone sealant that gives excellent unprimed adhesion to both porous + non-porous substrates. Ideal for weathersealing of curtain walling, building facades and expansion joints. Also suitable for use as a frame sealant.

D6009032 - White 310ml  
 D6009017 - Bronze 310ml

**DOW CORNING PAINTERS MATT FLEXIBLE ACRYLIC FILLER**

Ideal for use on door and window frames, skirting boards, ceilings, walls architraves and plasterboards.

D6009008 - Brown 310ml  
 D6009010 - White 310ml  
 D6009011 - Magnolia 310ml

**Sealants**



**DOW CORNING 201 ONE PART POLYSULFIDE SEALANT**

For external perimeter pointing of door and window frames and expansion joints.

- D6009007 - White 380ml
- D6009062 - Black 380ml
- D6009062 - Red 380ml
- D6009064 - Buff 380ml
- D6009066 - Grey 380ml
- D6009068 - Teak 380ml

**DOW CORNING SILICONE SEALANT REMOVER**

A gel for removing unwanted cured silicone sealant.

D6009006 - 100ml

**DOW CORNING ACRYLIC FRAME SEALANT**

A solvent free acrylic for sealing around door and window frames both internally and externally. Can be overpainted 4 hours after application.

- D6009200 - White 310ml
- D6009202 - Brown 310ml
- D6009204 - Natural 310ml
- D6009206 - Grey 310ml

**DOW CORNING 580 ONE PART OIL BASED MASTIC**

For new or remedial external applications including pointing of painted and seasoned timber door and window frames.

- D6010010 - White 380ml
- D6010012 - Grey 380ml
- D6010014 - Black 380ml

**DOW CORNING PLUMBA FLUE HIGH TEMPERATURE SILICONE SEALANT**

Ideal for sealing gas flues and once cured is able to withstand temperatures of up to 300 C.

D6010020 - Red 310ml

**DOW CORNING ROOF & GUTTER SEALANT**

Ideal for repairing and maintaining roof & gutters.

D6009130 - Black 310ml

**N & C**

**FLEXIBLE DECORATORS FILLER**

DE1001600 - White 400m

**SKELETON GUN**



**LAYBOND GRIPFILL**



Solvent based gap filling adhesive will bond a wide range of materials including, wood, metal, brick, and plasterboard

F1000002 - 350ml Cartridge

**Sealants**

## Adhesives



### LAYBOND MULTIBOND GOLD

Multibond gold is a multi-purpose acrylic floor covering adhesive for internal use. It will bond all vinyls (including cushioned types) and most carpets to asphalt, concrete, chipboard, hardboard, plywood and smoothing compounds.

- F1000029 - 1kg
- F1000031 - 2.5kg
- F1000030 - 5kg
- F1000032 - 15 kg

### SIROFLEX FLAMEGUARD

A fire retardant silicone with excellent adhesion to most building surfaces. Use where heat and fire resistance is required.

D8008001 - 310ml White

### SIROFLEX FIRE RETARDENT FOAM

Hand applied fire retardant filler foam for stone, brickwork & many other construction applications.

D8008002 - 700ml Natural



### SIROFLEX MIRROR ADHESIVE

Suitable for bonding mirrors up to 6mm thickness to concrete, wood, metal, glass, ceramic tiles and paintwork.

D8007850 - 310ml

### LAYBOND GRIPSEAL FOAM & FILL

Self expanding ready to use polyurethane foam. Forms a semi rigid cellular structure when cured which can be cut, plastered or painted.

D8009510 - 750ml

### SURESEAL MULTI PURPOSE PUTTY

This has been formulated for glazing, wood and metal framed single glass windows.

- |                  |                 |
|------------------|-----------------|
| Finish Brown     | Finish Natural  |
| D8008101 - 25kg  | D8008201 - 25kg |
| D8008102 - 10kg  | D8008202 - 10kg |
| D8008103 - 5kg   | D8008203 - 5kg  |
| D8008104 - 2kg   | D8008204 - 2kg  |
| D8008105 - 1kg   | D8008205 - 1kg  |
| D8008106 - 0.5kg |                 |

## Evo-Stik

### EVO-STIK PLUMBERS MAIT

Waterproof non-setting, non-cracking putty for sanitary installations.

- D6002801 - Grey 750 Gram
- D6002802 - Grey 1.5 kg
- D6002803 - Grey 3kg

### EVO STIK WEATHER PROOFING TAPE

For sealing glass roofs, gutters, drain pipes, greenhouses, corrugated sheeting etc

- D6003801 - 8m x 25mm
- D6003802 - 8m x 50mm
- D6003803 - 8m x 75mm
- D6003804 - 8m x 100mm

### EVO STIK EVOSWATHE

For sealing and rust proofing metal surfaces, frames and pipes

- D6004001 - 9m x 50mm
- D6004002 - 9m x 75mm
- D6004003 - 9m x 100mm

### EVO STIK IMPACT ADHESIVE

Provides a strong bond on contact, without the need for clamps or weights.

- D6004201 - 32gm Tube
- D6004202 - 67gm Tube
- D6004203 - 250ml
- D6004204 - 500 ml

### EVO STIK TIME BOND

A Thixotropic non-drip contact adhesive

- D6004401 - 1 Ltr
- D6004402 - 500ml
- D6004403 - 250ml

### EVO STIK RESIN 'W' EXTRA FAST WOOD ADHESIVE

A quick drying wood adhesive for interior use.

- D6005201 - 5 Ltr
- D6005202 - 2.5 Ltr
- D6005203 - 1 Ltr
- D6005204 - 500 ml
- D6005205 - 250ml
- D6005206 - 125ml
- D6004403 - 250ml

### EVO STIK 528 ADHESIVE

General Purpose Contact Adhesive Ideal for laminating.

- D6005601 - 5 Ltr
- D6005602 - 2.5 Ltr
- D6005603 - 1 Ltr
- D6005604 - 500ml

### EVO STIK 191 CLEANER

Provides a strong bond on contact, without the need for clamps or weights.

- D6004201 - 32gm Tube
- D6004202 - 67gm Tube
- D6004203 - 250ml
- D6004204 - 500 ml

### EVO STIK TX528 THIXOTROPIC ADHESIVE NON-DRIP

Ideal for use on vertical or horizontal surfaces.

- D6006001 - 5 Ltr
- D6006002 - 2.5 Ltr
- D6006003 - 1 Ltr





Naco

SELF ASSEMBLY DE LUXE LOUVRE WINDOWS

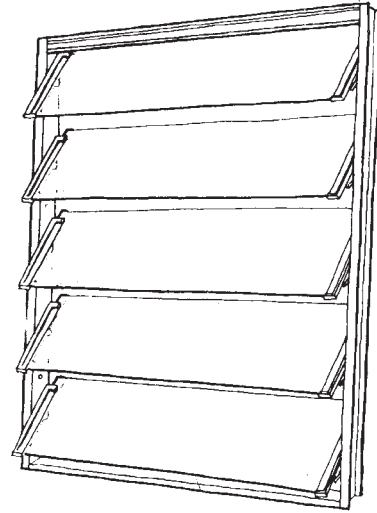

De luxe fully louvred windows combine the strength and stability of aluminium with modern technology in section moulded blade holders which ensure positive contact between each glass blade while providing an effective 'wiping action' seal at the jambs.

Each louvre set is packed in a sealed polythene bag with detailed fixing instructions and screws.

Note: Although the glass blades are not included they are available from N&C Glass Ltd on 020 8986 6212

STANDARD HEIGHT LOUVRE SETS

Sizes shown are the overall height of the louvre jamb.

Number of operating handles

Up to 5 blade = 1

6 to 10 blade = 2

11 to 15 blade = 3

G3100001	-	1 Blade	Louvre Set Standard Height	165mm white
G3100002	-	2 Blade	Louvre Set Standard Height	305mm white
G3100003	-	3 Blade	Louvre Set Standard Height	445mm white
G3100004	-	4 Blade	Louvre Set Standard Height	584mm white
G3100005	-	5 Blade	Louvre Set Standard Height	724mm white
G3100006	-	6 Blade	Louvre Set Standard Height	864mm white
G3100007	-	7 Blade	Louvre Set Standard Height	1003mm white
G3100008	-	8 Blade	Louvre Set Standard Height	1143mm white
G3100009	-	9 Blade	Louvre Set Standard Height	1283mm white
G3100010	-	10 Blade	Louvre Set Standard Height	1423mm white
G3100011	-	11 Blade	Louvre Set Standard Height	1562mm white
G3100012	-	12 Blade	Louvre Set Standard Height	1702mm white
G3100013	-	13 Blade	Louvre Set Standard Height	1842mm white
G3100014	-	14 Blade	Louvre Set Standard Height	1981mm white
G3100015	-	15 Blade	Louvre Set Standard Height	2121mm white

EXTENDED HEIGHT LOUVRE SETS

For non-standard heights use extended louvre sets which provide a fixed infill blade above the normal louvre unit which can be cut down to the required size on site.

Number of operating blades with extension shown. Sizes given will fit between opening heights stated.

G3200001	-	1 Blade	Louvre Set Extended Height	203mm-306mm White
G3200002	-	2 Blade	Louvre Set Extended Height	343mm-446mm White
G3200003	-	3 Blade	Louvre Set Extended Height	483mm-585mm White
G3200004	-	4 Blade	Louvre Set Extended Height	622mm-725mm White
G3200005	-	5 Blade	Louvre Set Extended Height	762mm-865mm White
G3200006	-	6 Blade	Louvre Set Extended Height	902mm-1004mm White
G3200007	-	7 Blade	Louvre Set Extended Height	1041mm-1144mm White
G3200008	-	8 Blade	Louvre Set Extended Height	1181mm-1284mm White
G3200009	-	9 Blade	Louvre Set Extended Height	1321mm-1424mm White
G3200010	-	10 Blade	Louvre Set Extended Height	1461mm-1563mm White
G3200011	-	11 Blade	Louvre Set Extended Height	1600mm-1703mm White
G3200012	-	12 Blade	Louvre Set Extended Height	1740mm-1843mm White
G3200013	-	13 Blade	Louvre Set Extended Height	1880mm-1982mm White
G3200014	-	14 Blade	Louvre Set Extended Height	2019mm-2122mm White +

Natural anodised aluminium also available.

LOUVRES

## Naco

### WEATHERBARS

Head and cill weather bars are extruded twin grade PVC material incorporating a flexible weather tongue.  
Colour: Grey

#### WEATHER BAR STANDARD HEAD

- G3320024 - 24" (610mm)
- G3320030 - 30" (760mm)
- G3320036 - 36" (914mm)
- G3320042 - 42" (1067mm)
- G3320045 - 45" (1142mm)
- G3320048 - 48" (1219mm)

#### WEATHER CILL

- G3340024 - 24" (610mm)
- G3340030 - 30" (760mm)
- G3340036 - 36" (914mm)
- G3340042 - 42" (1067mm)
- G3340045 - 45" (1142mm)
- G3340048 - 48" (1219mm)

#### WEATHERBAR FIXED HEAD

- G3360024 - 24" (610mm)
- G3360030 - 30" (760mm)
- G3360036 - 36" (914mm)
- G3360042 - 42" (1067mm)
- G3360045 - 45" (1142mm)
- G3360048 - 48" (1219mm)

### COUPLING SETS

For windows up to 10 blades high, coupling sets can be used to join any number of panels to form multiple panel assemblies.

- G3500005 - 1-5 Blade Coupling Set
- G3500050 - 6-10 Blade Coupling Set
- G3500055 - 11-15 Blade Coupling Set

### DROP ROD ATTACHMENT

Where 'out of reach' windows occur, drop rods can be fitted to the standard handle.

- G3400018 - 18" (450mm)
- G3400024 - 24" (610mm)
- G3400036 - 36" (900mm)
- G3400048 - 48" (1200mm)
- G3400060 - 60" (1500mm)

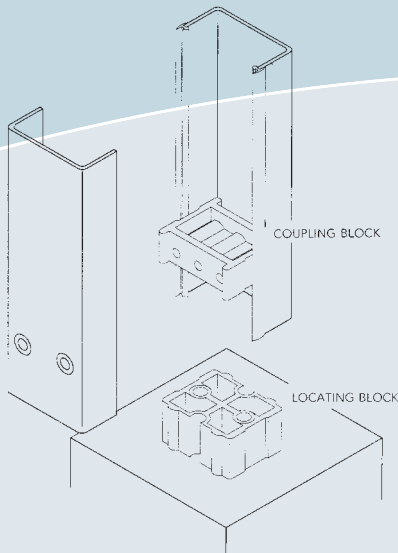

# N&C

## Nicobond



- Glass Tiles
- Fashion Ceramics
- Architectural Tiles
- Natural Stone
- Tumbled Marble
- Marble
- Healthcare
- Wall and Floor Products
- Metallics

N & C Nicobond have been manufacturing and supplying tiles and adhesives for over fifty years, our policy of supplying only quality products at competitive prices has enabled the company to become one of the leading suppliers in the market place.

The N & C Nicobond range is vast and new products are constantly being introduced. The following pages show just a few of our products but our sales team are at your service to supply samples and discuss any requirements of your projects.



## The N&C Nicobond White Collection

The N & C Nicobond White Collection has been carefully developed to offer the widest variety of design opportunities in this ever popular colour.

Surface finishes may be flat, bumpy or bevelled with glazes in gloss or matt and many size options

T1220928	- NB8681	200 x 150	Gloss White
T1220930	- NB8682	200 x 150	Matt White
T1220936	- NB8685	200 x 200	Bumpy White
T1220938	- NB8686	200 x 200	Gloss White
T1220940	- NB8687	200 x 200	Matt White
T1220970	- NB8700	200 x 200	Bevel White
T1220950	- NB8691	200 x 250	Bevel White
T1220952	- NB8692	200 x 250	Gloss White
T1000260	- NB8690	200 x 250	Bumpy White
T1220956	- NB8694	200 x 300	Bumpy White
T1220958	- NB8695	200 x 300	Bevel White
T1220960	- NB8696	200 x 300	Gloss White
T1220000	- NB8280	300 x 300	Bevel White
T1220001	- NB8279	300 x 300	Gloss White



To compliment the N & C Nicobond white collection

there is a wide selection of decorative borders available.

Please contact our sales team for full details

## The N&C Nicobond Plain Colour Collection

The N & C Nicobond plain colour range offers simplicity of style, value for money, with an impressive range of colours, catering for the simplest of splashbacks to the most complex of designs.

- Conforms to European & British standards
- Confirms to Ral design system
- Comprehensive range of colours, finishes and sizes. 150x150,200x200,150x23
- Pastels and bright tones, gloss, matt and bumpy
- Glazed edges
- Established for over 20 years
- Guaranteed colour range availability for 5 years



N&C Building Materials are also major stockist of:  
GRES PANIA • PILKINGTON • H&R JOHNSON • WOOLISCROFT • DANIEL PLATTS • LONGMEAD

## N & C Nicobond Maronagres Range



A highly competitive Porcelain unglazed tile in a comprehensive range of 27 colours, 3 sizes, and 4 finishes Natural, Polished Studded and Riven.

7 Colours in 30 x30cm, natural finish are available ex-stock.

All other variations along with skirting Tiles and step treads are available to special order.

30 x 30 Natural Finish

T2533160 - COL16 Black

T2533220 - COL32 White

T2533170 - COL17 Rosia Granito

T2533200 - COL20 Blue Granito

T2533330 - COL33 Beige Granito

T2533410 - COL41 Platinum Granito

T2533750 - COL75 White Granito

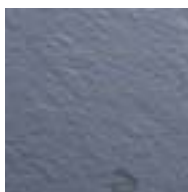

Riven



Studded



Step tread

## The N&C Nicobond Travetine Range



A unique combination of a classic natural stone effects with a substantially higher technical performance than the natural product giving the Travertine range endless possibilities. The natural beauty which is highlighted in the marbling and variegated tones makes each piece unique. The combination of these subtle tones can be intermixed with the Maronagres or Architects range, thus giving the maximum appeal in design and colour.

## The N&C Nicobond Easicare Antibacterial Tile Range



Easicare-Anti-Bacterial tiles feature a surface treatment that gives high self-cleaning and bacterial eliminating qualities. These exceptional properties come from using a licensed Japanese technique - HYDROTECT. A transparent film of Titanium Dioxide and inorganic components have no effect on the appearance and mechanical properties of the tiles, it does however improve their hygienic properties due to the hydrophilic and anti-bacterial effect.

### HYDROPHILIC EFFECT

The surface treatment is activated by UV rays after which the surface tension between water and the tile surface is greatly reduced. This effect creates a continuous water film wetting that dissolves and washes away dirt particles. This treatment to the tile surface has the washing ability that is comparable to a strong solution of detergent.

### ANTI-BACTERIAL EFFECT

When oxygen and air humidity reacts with the UV rays the film creates a source of active oxygen which oxidises and destroys organic substances such as bacteria, mildew, fungus etc. Tests have shown that 99% of all bacteria is eliminated in 30 minutes.



## Nicobond Ultragrip Ceramic Wall Tile Adhesive



A white, acrylic emulsion based, ready to use thin-bed adhesive for ceramic wall tiles.

**Features**

- Non-slip
- Easy to spread
- High grip for heavier tiles
- Ready mixed for immediate use
- Excellent adhesion to clean, sound surfaces.

**N1030001 - 10 Ltr**

**N1030003 - 5 Ltr**

Exceeds the performance BS EN 12004 and BS 5980.

## Nicobond Aqua Ultragrip



A white, acrylic emulsion based, ready to use thin-bed adhesive for ceramic wall tiles.

**Features**

- Non-slip
- Easy to spread
- High grip for heavier tiles
- Ready mixed for immediate use
- Excellent adhesion to clean, sound surfaces.
- Class AA waterproof adhesive

**N1070001 - 10 Ltr**

**N1070003 - 5 Ltr**

Exceeds the performance BS EN 12004 and BS 5980.

## Nicobond Tile



A white ready to use, acrylic emulsion based, thin-bed adhesive for interior wall tiling.

**Features**

- Easy to spread
- Non-slip
- Ready mixed for immediate use
- Excellent adhesion to clean, sound surfaces
- White, does not discolour tiles
- Minimises stress on tiles

**N1020001 - 10 Ltr**

**N1020003 - 5 Ltr**

**N1020005 - 2 Ltr**

**N1929996 - 1 Ltr**

Exceeds the performance BS EN 12004 and BS 5980.

## Nicobond Waterproof Tile Cement Cement



A white, ready to use, waterproof acrylic emulsion based, ammonia free, thin bed adhesive for tiling wall areas subjected to constant splashing or running water.

**Features**

- Waterproof
- Ready mixed for immediate use
- Ideal for power showers
- White, does not discolour tiles
- Ammonia free
- Excellent adhesion to clean sound surfaces.

**N1040001 - 10 Ltr**

**N1040003 - 5 Ltr**

**N1040005 - 2 Ltr**

**N1040006 - 1 Ltr**

Exceeds the performance BS EN 12004 and BS 5980.

## Nicobond Tile Adhesive/Grout



A ready to use, waterproof, acrylic emulsion based thin-bed adhesive and grout.

### Features

- Ready mixed for immediate use
- Suitable for use in interior or exterior situations
- Excellent adhesion to clean, sound surfaces
- Dries to super white finish
- High water resistance
- Excellent adhesion to the porous or glazed edge of tiles
- Compressible.

N1260002 - 8 Ltr  
 N1260004 - 4 Ltr  
 N1260005 - 2 Ltr  
 N1260006 - 1 Ltr  
 N1260007 - 0.5 Ltr

Exceeds the performance BS EN 12004 and BS 5980.

## Nicobond Tile To Timber



A ready mixed, waterproof, beige coloured acrylic emulsion based adhesive for interior tiling direct onto timber surfaces.

### Features

- Highly flexible
- Class AA performance
- Very high bond strength
- Versatile
- Waterproof
- Ready mixed
- Easy to apply and spread
- Tile direct to T & G boards
- No need to prime.

N1201065 - 15 kg

Exceeds the performance BS EN 12004 and BS 5980.

## Nicobond Floor & Wall Adhesive



A thin or thick-bed, waterproof, cement based adhesive. For the interior or exterior bonding of ceramic wall and floor tiles, mosaic, slip brick, marble, granite and other natural stones.

### Features

- Non Slip
- Ready for use immediately after mixing
- Supplied in Grey or White
- Suitable for tiling swimming pools.

### White

N1120050 - 20 kg  
 N1120051 - 10 kg  
 N1120052 - 5 kg

### Grey

N1140050 - 20 kg  
 N1140051 - 20 kg  
 N1140052 - 20 kg

Exceeds the performance BS EN 12004 and BS 5980.

## Nicobond Xtra



A thin or thick-bed, high build, waterproof, fast setting cement based adhesive with additional resins for superior performance. Use in interior or exterior situations for bonding ceramic wall and floor tiles, mosaic, slip brick, marble, granite and other natural stones.

### Features

- High build with no slump
- Traditional mortar 'feel'
- Specially suited to heavier floor tiles and pavements
- Supplied in White and Grey
- Suitable for use in swimming pools
- Ready for use immediately after mixing | Rapid body strength development

N1150050 - White 20 kg  
N1150150 - Grey 20 kg

Exceeds the performance BS EN 12004 and BS 5980.

## Nicobond Fast Floor and Wall Adhesive



A grey, thin or thick-bed, waterproof, cement based adhesive. For Bonding ceramic wall and floor tiles, mosaic, slip bricks, marble, granite and natural stones.

### Features

- Suitable for use in interior or exterior situations
- Sets in less than 1 hour
- Suitable for tiling swimming pools
- Excellent initial grab
- Non-Slip
- Ready for use immediately after mixing

N1160050 - 20kg  
N1160051 - 10kg  
N1160052 - 5 kg

Exceeds the performance BS EN 12004 and BS 5980.

## Nicobond Rapidflex



A single part, rapid setting, thin or thick-bed flexible adhesive for fixing ceramic wall and floor tiles, mosaic and natural stones in interior or exterior situations where a resilient bond is required.

### Features

- Resilient when set
- Water resistant
- Rapid bond strength development
- Sets in 2-3 hours
- Grout after 3 hours
- Excellent initial grab
- Non-slip | Ready for use immediately after mixing.

Grey  
N1150250 - 20 kg  
White  
N1150450 - 20 kg

Exceeds the performance BS EN 12004 and BS 5980.

## Nicobond Unique

A brilliant white, quick setting, thin or thick-bed adhesive in powder form for fixing most types of rigid cladding materials to gypsum plaster in interior applications.

### Features

- Unique - the only powder adhesive recommended for direct bonding to gypsum plaster
- Fast setting - grout after approx. 1 hour
- Brilliant white colour
- Does not cause ettringite failure
- Cement-free, environment and user friendly
- Non-slip
- Exceptionally high grab with large format tiles
- Easy to mix and apply
- Ready for use immediately after mixing
- Versatile - thin or thick bed applications  
Priming plaster not required.

N1160265 - 15 kg

Exceeds the performance BS EN 12004 and BS 5980.



## Nicobond Flexible Adhesive

A grey two part adhesive consisting of a compounded, cementitious, polymer based powder and a latex based liquid. For use in interior and exterior situations. Thin or thick-bed application for bonding ceramic wall and floor tiles and mosaic.

### Features

- Designed for situations where vibration or slight background movement is likely
- Supplied in two pre-measured units for ease of mixing
- Resilient when set
- Water resistant
- Excellent bond strength.

N1200058 - 7 kg

N1200003 - 5 Ltr

Exceeds the performance BS EN 12004 and BS 5980.



## Nicobond Marble & Granite Adhesive

A thin or thick-bed, waterproof, white cement based adhesive for the fixing of natural stone tiles or cladding in interior and exterior situations. Bonds marble, granite, slate, limestone and other natural stone materials.

### Features

- White colour, will not stain lightly coloured marble
- suitable for tiling swimming pools
- Suitable for walls and floors
- Ready to use immediately after mixing.

N1170050 - 20 kg

Exceeds the performance BS EN 12004 and BS 5980.



## Nicobond Mosaic Adhesive And Grout



A cement based, waterproof adhesive and grout for use in interior or exterior Fixing of ceramics, mosaics and natural stone.

**Features**

- Dual Purpose - Adhesive and Grout
- Suitable for tiling swimming pools
- Time saving
- Ready for use immediately after mixing
- Rapid grouting capability
- Non-Slip
- Suitable for use in interior or exterior situations.

**Super White**

N1175050 - 20 kg

**Grey**

N1175550 - 20 kg

**Flint**

N1176050 - 20 kg

Exceeds the performance BS EN 12004 and BS 5980.

## Nicobond Tilers Grout



A cement based, waterproof grouting material suitable for interior and exterior applications.

**Features**

- Good adhesion to the porous or glazed edges of tiles
- Compressible
- Suitable for walls and floors
- Supplied in White, Grey and an attractive range of factory blended colours
- Formulated specifically for tiling contractors
- Ready blended, just add to water
- Ready for use immediately after mixing.

**White**

N1300050 -20 kg

N1300051 -10 kg

N1300052 - 5 kg

N1300053 -2.5 kg

N1300054 -1.5 kg

N1300055 -500 g

**Grey**

N1301050 -20 kg

N1301051 -10 kg

N1301052 - 5 kg

N1301053 -2.5 kg

**Ivory**

N1302053 -2.5 kg

**Limestone**

N1301063 -2.5 kg

**Mid-Brown**

N1301553 -2.5 kg

**Dark Chocolate**

N1304553 -2.5 kg

Exceeds the performance BS EN 12004 and BS 5980.

## Nicobond Floor Tile Grout



A cement based, water repellent floor grouting compound for ceramic floor tiles, quarries, pavers and natural stones. Suitable for interior and exterior applications.

**Features**

- Hard abrasion resistant finish
- Easy to mix, apply and clean from tile surface
- Good adhesion to the porous edges of tiles
- Water repellent but vapour permeable
- Ready for use immediately after mixing
- Low porosity resists water and dirt penetration
- Available in Brown, Flint, Black, Grey and Sandstone.

**Grey**

N1381550 - 20 kg

N1381551 - 10 kg

**Brown**

N1381050 - 20 kg

N1381051 - 10 kg

**Sandstone**

N1381650 - 20 kg

N1381651 - 10 kg

Exceeds the performance BS EN 12004 and BS 5980.



## Nicobond Pointing Mortar Wide Joint Grout

A cement based, water repellent, grouting material for wide joint grouting or pointing of ceramic tiles, slip bricks and natural stones in interior or exterior applications.

### Features

- Suitable for walls and floors
- Water repellent but vapour permeable
- Good adhesion to porous edges of tiles
- Compressible
- Available in Super-White, Off-White, Grey, Flint, Brown and a wide range of custom colours.

### Super White

N1361050 - 20 kg

### Off-White

N1360050 - 20 kg

### Grey

N1360550 - 20 kg

Exceeds the performance BS EN 12004 and BS 5980.



## Nicobond Enhancer 2002

A highly modified acrylic resin emulsion which improves the properties of Nicobond cementitious adhesives and grouts under demanding conditions.

### Features

- Increases adhesive and grout adhesion, cohesive strength and elasticity
- Compatible with the range of Nicobond cementitious adhesives and grouts
- Easy to use
- Water based
- Non-flammable
- Reduces the water permeability of the finished product
- Reduces efflorescence in exterior applications
- Versatile - one product for all requirements.

N1440020 - 120 Ltr

N1440011 - 25 Ltr

N1440004 - 4Ltr

N1440006 - 1 Ltr



## Nicobond Easiclean Epoxide

A 3 part kit for grouting and bonding ceramics in interior and exterior situations, for joint widths 2mm to 12mm. very economical and easy to use.

### Features

- Increased compressive, tensile and adhesive strengths
- Improved resistance to dilute chemicals and stains
- Available in White, Grey
- Factory-measured kit for consistent results
- Easy to use
- Gives improved chemical and physical properties compared to conventional cement-based grouts but retains their ease of use

### White

N1350061 - 10 kg

### Grey

N1350161 - 10 kg

Exceeds the performance BS EN 12004 and BS 5980.



## Nicobond Trueepoxy

A fast setting, exceptionally easy to use, two-part epoxy resin based, new generation wall and floor tile adhesive and grout for interior and exterior applications.

### Features

- Easy to apply to walls: no slump
- Easy to apply to floors: rapid spread
- Easy to clean off - with only water
- Will adhere to most surfaces excluding plastic and fibreglass.

### Grey

N1331060 - 4 kg

N1331062 - 1 kg

### White

N1330060 - 4 kg

N1330062 - 1 kg

### Ivory

N1332060 - 4 kg

N1332062 - 1 kg

Exceeds the performance BS EN 12004 and BS 5980.



## Nicobond Colour Blend

A range of high strength coloured powder pigments for mixing with cementitious adhesives and grout.

### Features

- High strength undiluted pigments
- Versatile - can be blended with both cementitious and epoxy resin grout
- Highest permanence rating
- Easy to blend | Available in Red, Yellow, Green, Blue, Brown and Black
- All colours intermixable, individual sachets containing 25g (small) or 200g (large).

### Red

N1420065 - 25 gm

### Yellow

N1420565 - 25 gm

### Green

N1421565 - 25 gm

### Blue

N1421065 - 25 gm

### Brown

N1422565 - 25 gm

### Black

N1422065 - 25 gm



## Nicobond Water Screed (Protein Free)

A high quality polymer modified cementitious powder smoothing compound for interior use prior to laying decorative floor coverings on sand and cement floors. Grey when set.

### Features

- Protein free - inhibits the growth of bacteria
- Self-smoothing
- Very easy to use
- Only requires water for mixing
- Possesses a self curing property which assists in retaining moisture in the compound and eliminates the need for damping down
- Cures very hard.

N1480050 - 20 kg

Exceeds the performance BS EN 12004 and BS 5980.



## Nicobond Latex Screed

A versatile, two part, smoothing compound for interior use when a flexible type of underlayment is required.

### Features

- Provides a more flexible underlayment than water mixed screeds
- Versatile, suitable for surfacing most types of floors
- Can be laid to a feather-edge
- Quick setting and easy handling properties
- Self-smoothing
- MSA approved for ships decking
- Good adhesion to a wide range of surfaces.

N1500050 - 20 kg

N1500004 - 4 Ltr



## Nicobond Multiflo Screed (Protein Free)

A unique, protein free, self-levelling, self-smoothing, fast setting underlayment. Cementitious powder, light grey when set. Feather edge to 35mm and over

### Features

- Versatile, pourable alternative to sand/cement screeds
- Mix with water only - self-smoothing and self-levelling
- Very rapid setting (about 2 hours) reduces installation time
- Early, high load-bearing capacity
- Very smooth surface finish
- Protein free - inhibits the growth of bacteria
- Suitable for environmentally sensitive areas
- Shrinkage compensated
- One product for single application from feather edge to 35mm or more
- Accepts all known flooring adhesives and floor paints.

N1570050 - 20 kg



## Nicobond Acrylic Screed (Protein Free)

A heavy duty system consisting of a cementitious powder and a modified acrylic emulsion suitable for use as an indoor or outdoor smoothing compound or as a hard, tough wearing surface for industrial floors. Grey when set.

### Features

- Protein free - inhibits the growth of bacteria
- Can be laid to feather - edge
- A more flexible underlayment than Nicobond Water Mix Screed but harder than Nicobond Latex Screed
- Self-smoothing
- Will accept floor paints | Compared with a sand/cement mix, gives the following increases: Flexural strength - + 83% Compressive strength - + 27%, Abrasion resistance - 11.7 times.

N1520050 - 20 kg

N1520004 - 4 Ltr



## Nicobond Speedset Cement



A low-alkalinity cementitious powder replacement for the production of fast setting, fast drying, shrinkage compensated interior floor screeds.

**Features**

- Versatile - replaces cement in bonded, unbonded and floating floor screeds
- Rapid setting - takes foot traffic after 3 hours at 23°C
- Rapid drying - ceramics and "soft" floor coverings can normally be fixed after 24 hours
- Rapid strength development - after 24 hours, compressive and tensile strengths exceed conventional screeds at 28 days
- Shrinkage compensated - produces low shrinkage screeds.

**N1510058 - 25 kg**

## Nicobond Granite Chips



Clean, dry graded basaltic chippings.

**Features**

- Increases the bulk and strength of Nicobond Water Mix Screed, Nicobond Latex Screed and Nicobond Acrylic Screed when these products are applied at bed thicknesses over 5mm or in the case of Nicobond Multiflo over 10mm and up to 20mm.
- Greatly improves the abrasion resistance and durability of Nicobond Acrylic Screed when used as a wearing surface.
- Low dust content.

**N1620058 - 25 kg**

## Nicobond Granite Chips



A white granular, crystalline, medium alkalinity detergent containing a high proportion of special surfactants. For removing dirt, fats, grease, oils, polish from all types of sub-floors, including things that would be attacked by solvent-based cleaners, prior to the application of Nicobond Screed products.

**Features**

- Readily soluble in water
- Does not contain caustic soda
- Safe for use on asphalt
- High detergent content.

**N1600075 - 8 kg**

## Nicobond Screed Pitch

An all liquid, cold curing two-component pitch modified epoxy resin system. Black and shiny when cured. Produces a tough seamless membrane on cementitious floors subject to capillary rising damp.

### Features

- Tough, water resisting membrane for most floors
- Easy to use
- Effective against capillary rising damp
- Rapid curing
- Suitable for use in food preparation areas
- Compatible with Nicobond Latex Screed, Nicobond Acrylic Screed and Nicobond Multiflo screed.

N1580071 - 10 sq m kit



## Nicobond Primer

An off white acrylic emulsion-based liquid for use prior to application of Nicobond ceramic tile adhesives and floor surfacing compounds.

### Features

- Interior and exterior use
- Increases adhesion of cement-based ceramic tile adhesive and surfacing compounds
- Water-based and non-flammable
- Dries almost transparent, will not stain
- Reduces porosity of surfaces.

N1460003 - 5 Ltr

N1460006 - 1 Ltr



## Nicobond Kwikset

A rapid setting, versatile, cement based repair product. For repairing paths, steps, walls. Can be used for pointing brickwork, rendering sills, fixing gate posts, brackets and catches. Underwater repairs may be carried out with this material. Fish ponds require special treatment before stocking with fish (as normal practice for aquatic structures).

### Features

- Quick setting
- Dark grey when set
- Can be used for underwater repairs
- For most concrete repair jobs
- Sand can be added to mixture.

N1780080 - 6 kg

N1780081 - 3 kg



## Nicobond Universal Bonding Agent and Sealer (UBAS)

A specialised PVA emulsion suitable for most building site jobs and general repairs.

### Features

- Excellent aid to bonding
- Seals porous surfaces
- Non-staining and non-flammable
- Easy to use
- Exceeds requirements of British Standards 5270: 1976 for PVA bonding agents
- White as liquid but dries to an almost transparent film.

N1760011 - 25 Ltr

N1760003 - 5 Ltr

N1760005 - 2.5 Ltr

N1760006 - 1 Ltr Polytin

N1760506 - 1 Ltr Squeezy

Conforms to BS 5270.





## Nicobond Render Improver



White liquid, blend of acrylic and other polymer emulsions for improving the bond of key-coats and strengths of renders.

### Features

- Suitable for interior and exterior use
- Superior bonding-agent additive for key-coating renders to new or old concrete
- Ideal for use with spatterdash
- Improves workability of renders, even those containing harsh sands
- As admixture, improves tensile, flexural and compressive strength of renders
- Lowers water demand, reduces mortar shrinkage
- Reduces water penetration, improves freeze/thaw resistance
- Chloride free
- One product - multiple applications.

N1910020 - 200 Ltr

N1910008 - 25 Ltr

N1910003 - 5 Ltr



## Nicobond M.R. Glue Woodworking Adhesive



A high performance water resistant wood adhesive for inside and outside use.

### Features

- Ready mixed for immediate use
- Suitable for interior and exterior use
- High ultimate bond strength - normally stronger than wood
- Rapid development of bond strength
- Good water resistance when set
- Resists staining by tannin (e.g. oak)
- Water based, non-flammable and non-toxic in normal use
- White when wet - dries to an almost transparent film.

N1820011 - 25 Ltr

N1820004 - 4 Ltr

N1820006 - 1 Ltr

N1820007 - 0.5 Ltr

## Nicobond Silicone Sealant



One pack, ready to use, high modulus, acetoxo silicone rubber paste.

### Features

- Fungus resistant sealant
- Ready mixed for immediate use
- Colour stable White and Clear
- Suitable for use in both interior and exterior applications
- Resists mildew, heat, moisture, UV radiation, steam, ozone etc
- Hygienic
- Durable, permanently elastic
- Non-slump, rapid cure
- Service temperature range:- 400C to + 1600C.

N1720015 - White 310 ml

N1720515 - Clear 310 ml

**Nicobond Tool and Accessories**



Nicobond

Tiling Tools and Accessories

- N2500000 - Notched Trowel 6mm. Square Notch Trowel with Wooden Handle
- N2520185 - Bucket Trowel Large Format 7" x 4 1/2"
- N2500500 - Grouter, Squeegee 200mm Long with Wooden Handle
- N2501500 - Float Grouter (Rubber faced), Deluxe Float Grout with Wooden Handle
- N2520150 - Epoxy Float Grouter (Green) with Green Base, used for Epoxy Grouts
- N2520180 - Grout Remover - Professional, A Professional Grout Removal Tool with Plastic Handle
- N2511000 - Skeleton Gun 400ml Suitable for All Sealant Cartridges
- N2520145 - Mitreright (for Perfect Angles on PVC Trim)
- N2512000 - Sponge, used for General Cleaning Procedures
- N2520155 - Pro-Sponge, Professional Hydro Cleaning Sponge
- N2519000 - Gunit (15 Units Per Pack ) Empty Sealant Cases used in Co-ordination with Epoxy Grouts
- N2520190 - Tile Cutting Professional Nipper 8". Nippers for a Professional Job
- N2520000 - Tile Cutting Quarry Nipper 10". Heavy Duty Professional Nippers
- N2520010 - Tile Cutting Parrott Nipper 8". Nippers used for the Cutting out of Circles
- N2520015 - Tile Scriber/Grout Finisher. Dual Purpose Tool for Scribing Tiles and Smoothing Grout
- N2520020 - 2 in 1 Tile Scriber/Breaker. Dual Purpose Tool for the Scribing and Snapping of Tiles
- N2520025 - Tile Combination Saw 12". Professional Tile Saw with Adjustable Handle
- N2520030 - Tile Cutting Machine 400mm Economy
- N2520035 - Wall Tile Spacers X Type 2mm (500 Per Pack)
- N2520040 - Wall/Floor Tile Spacers X Type 3mm (250 Per Pack)
- N2520045 - Wall/Floor Tile Spacers X Type 3mm (500 Per Pack)
- N2520050 - Floor Tile Spacers X Type 4mm (250 Per Pack)
- N2520060 - Floor Tile Spacers X Type 5mm (250 Per Pack)
- N2520065 - Wall Tile Spacers Peg Type (500 Per Pack)
- N2520070 - Plastic Handle Adhesive Comb 6mm. Economy Hand Held Spreader with 6mm Notches
- N2520075 - Gauging Trowel 7". Wooden Handle Trowel
- N2520080 - Circular Tile Cutter 20mm - 94mm. Professional Hole Cutter with Alan key
- N2520085 - Rubber Mallet 65mm
- N2520090 - Chalk Line, to Allow Straight Lines for Tiling
- N2520100 - Tiling Hammer
- N2520105 - Tiling Chisel
- N2520110 - Knee Pads
- N2520115 - Tile Lifting Suction Pad, to Allow Safe Lifting of Longer Tiles
- N2520120 - Mixing Whisk 30", for correct mixing of Nicobond Adhesives
- N2520125 - Tile Drill Twin Pack 6mm & 12mm, for Use with Ceramic Tiles
- N2520165 - Washset - (Professional Box Contents: 22 ltr Bucket; 4 Castors; 2 Rollers; 1 Hydro Sponge; 1 Grout Float)
- N2520170 - Replacement Washset Hydro Sponge
- N2520175 - Replacement Washset Grout Float
- N2520200 - Nicobond Angle Grinder (Supplied with Dry Cutting Wheel 600 Watts 115mm Cutting Depth)
- N2520205 - Dry Cutting Continuous Diamond Wheel (for above - 115mm)
- N2520210 - Nicobond Wet Wheel Tile Cutter (500 Watts 118mm Wheel Diameter)
- N2520215 - Spare Diamond Blade (for above)
- N2520220 - Nicobond Grout Emulsifying Set (1 Gripper+1 Fine Pad +1 Coarse Pad)
- N2520225 - Nicobond Fine Emulsifying Pad (White)
- N2520230 - Nicobond Coarse Emulsifying Pad (Black)
- N2520240 - Nicobond Laser Level (Complete with Tripod and Case)
- N2520245 - Nicobond Triangular Tile Hole Cutter (2-73mm For Ceramic and Porcelain Tiles)

£

## Rubi Professional Tile Cutters



Rubi provides a range of manual tile cutters that enables you to make cuts without the need of electrical machinery on materials such as Quarry Tiles, Porcelain, Ceramic Tiles, etc.

- High performance single-point breaker
- Lateral stop for making repetitive cuts.
- Ergonomic shaped and reinforced base
- Special mounting for the breaking system lever
- Supplied with case and a complete set of tools

**N4000500 - TS 30 Cutter, Maximum Cutting Length 360mm**

**N4001000 - TS 40 Cutter, Maximum Cutting Length 430mm**

**N4001250 - TS 50 Cutter, Maximum Cutting Length 570mm**

**N4001500 - TS 60 Cutter, Maximum Cutting Length 660mm**

### SPARE WHEELS FOR MANUAL TILE CUTTERS

**N4016000 - Rubi 6mm Width, Scoring Wheel 01945, for Regular Files**

**N4016030 - Rubi 8mm Width, Scoring Wheel 01958, for Standard Tiles and Stoneware**

**N4016500 - Rubi 10mm Width, Scoring Wheel 01946, for Stoneware**

In addition to the Rubi manual tile cutters we are also able to supply:

- Electric cutting and mitring saws
- Diamond blades
- Other manual tile cutters
- Other manual tiles, stoneware, marble, granite, etc.

## Nicobond PVC Trims and Seals

### PVC TRIM REGULAR



A Standard regular Tile Trim for use with wall and floor tiles

**N3020001** - ETR608 6mm White Tile Trim 2.5m  
**N3025001** - ETR808 8mm White Tile Trim 2.5m  
**N3026001** - ETR108 10mm White Tile Trim 2.5m

\* Other Colours Available

### PVC TRIM PLUS

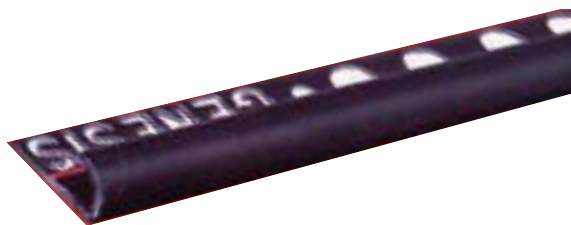

A Tile Trim that has a peelable red strip, to allow better fitting trim and cut tiles.

**N3030001** - ETR608 6.4mm White Tile Trim 2.5m  
**N3035001** - ETR908 9mm White Tile Trim 2.5m  
**N3036001** - ETR120 12mm White Tile Trim 2.5m

\* Other Colours Available

### PVC TILE TRIM



Extruded bath seal trim designed to bridge reasonable gaps

**N3110001** - STS180 White Tile Seal 1.8

\* Other Colours Available

### PVC INTERNAL TRIM PLUS



Internal trim generally used with ceramic tiles, providing cover for rough cut edges on horizontal or vertical edge.

**N3113000** - ETIO60 White Internal Trim 2.5m

\* Other Colours Available

### PVC SEAL PLUS/ SEAL SELF ADHESIVE

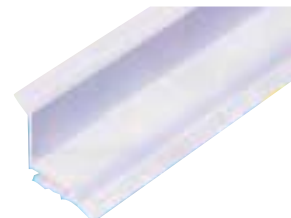

**N3120001** - White Extruded Bath Seal Designed to be Fixed with Silicone 1.8m

**N3120001** - White Extruded Bath Seal in Coprating Self Adhesive type 1.8m

\* Other Colours Available

## Nicobond Metal Trims and Seals

### ALUMINIUM ROUND EDGE TRIM

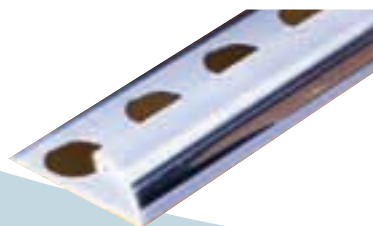

A Semi Quadrant face offers a pleasing finish to wall and floor tiles

**N3310001** - ERA060 Finish 80 Aluminium Mill Finish 2.8m  
**N3312001** - ERA060 Finish 81 Aluminium Matt Silver Finish 2.5m  
**N3310020** - ERA060 Finish 91 Aluminium Bright Silver Finish 2.5m  
**N3310002** - ERA080 Finish 80 Aluminium Mill Finish 2.5m  
**N3312002** - ERA080 Finish 81 Aluminium Matt Silver Finish 2.5m  
**N3310022** - ERA100 Finish 91 Aluminium Bright Silver Finish 2.5m

\* Other Colours and Sizes Available

### ALUMINIUM SQUARE EDGE TRIM

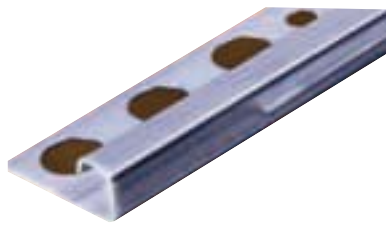

A Robust L-angled profile for finishing off and protecting the edge of materials.

**N3314001** - ESA060 Finish 80 Aluminium Mill Finish 2.8m  
**N3313001** - ESA060 Finish 81 Aluminium Matt Silver Finish 2.5m  
**N3311030** - ESA060 Finish 91 Aluminium Bright Silver Finish 2.5m  
**N3311002** - ESA080 Finish 80 Aluminium Mill Finish 2.5m  
**N3313002** - ESA080 Finish 81 Aluminium Matt Silver Finish 2.5m  
**N3311032** - ESA100 Finish 91 Aluminium Bright Silver Finish 2.5m

\* Other Colours and Sizes Available

### STAINLESS STEEL STRAIGHT EDGE TRIM

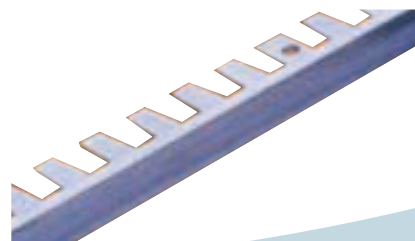

A rolled stainless steel profile with clutch bead head. Being stainless steel, ideal where high levels of hygiene are required.

**N3338002** - 6mm Trim 2.5m Stainless Steel Finish  
**N3338004** - 8mm Trim 2.5m Stainless Steel Finish  
**N3311030** - 6mm Trim 2.5m Aluminium Bright Silver finish  
**N3311002** - 8mm Trim 2.5m Aluminium Mill Finish 2.5m  
**N3313002** - 8mm Trim 2.5m Aluminium Matt Finish 2.5m



## Nicobond Transition Strips

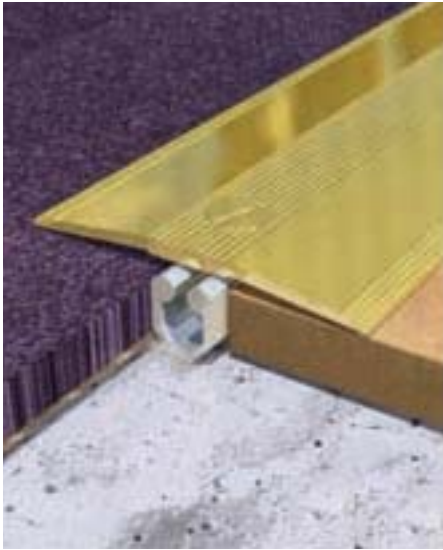

### ALUMINIUM TILE TO CARPET COVER

- N3080020 - TCA 250 Tile to Carpet/Cover  
2.5 Silver 91 Small 25mm x 2mm
- N3080022 - TCA 250 Tile to Carpet/Cover  
2.5 Brass 87 Small 25mm x 2mm
- N3080014 - TCA 350 Tile to Carpet/Cover  
2.5 Silver 91 Small 40mm x 5.5mm
- N3080018 - TCA 350 Tile to Carpet/Cover  
2.5 Brass 87 Small 40mm x 5.5mm
- N3080012 - TCA 400 Tile to Carpet/Cover  
2.5 Silver 91 Small 22mm x 5mm
- N3080016 - TCA 400 Tile to Carpet/Cover  
2.5 Brass 91 Small 22mm x 5mm

### ALUMINIUM TILE TO CARPET BASE

- N3080010 - TBA 250 Tile to Carpet Base  
2.5mm Aluminium

\* Many other Transition Strips Available

## Nicobond Movement Joints

### PVC MOVEMENT JOINT LIGHT DUTY



Light duty movement joints should be selected for areas that are primarily used by pedestrian traffic. Typical usage would be Hotel Reception Areas, Restaurants, Retail Outlets, Leisure Centres and Domestic applications.

- N3200184 - MLD080 Light Duty Movement Joint Black Finish 16 8mm x 25m
- N3200185 - MLD105 Light Duty Movement Joint Black Finish 16 10.5mm x 2.5m

\* Many other Transition Strips Available. Colours available

### ALUMINIUM MOVEMENT JOINT MEDIUM DUTY POLYURETHANE INFILL



Medium duty loading joints should be selected when impact from rolling loads and heavy point loading is anticipated. The medium duty joints are suitable for such locations as Supermarkets, Shopping Malls, Car Showrooms, Airport Concourses, and Railway Stations.

- N3200187 - MMA 100 Aluminium Movement Joint Medium Duty with Black Polythene Infill 10mm x 2.5m
- N3200188 - MMA 150 Aluminium Movement Joint Medium Duty with Black Polythene Infill 15mm x 2.5m

\* Many other Transition Strips Available

\* THERE ARE MANY OTHER COLOUR/SIZE COMBINATIONS AVAILABLE

\* MANY OTHER TRIMS AND SEALS AVAILABLE FROM STOCK OR SPECIAL ORDER, THESE INCLUDE:  
STAIR NOSINGS, EDGE PROTECTION, RAMPS, METAL TRIMS, LISTELLOS, SEALS, TRANSITIONS, SKIRTINGS,  
COVERS, PVC TRIMS ETC.



## Aquapanel Plus

Aquapanel a durable building board with exceptional wet strength performance. This board is suitable as a tile backer and floor underlayment in wet or humid areas such as kitchens and bathrooms.

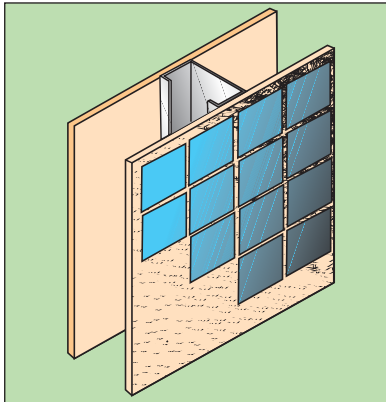

### TILE BACKING BOARD

Aquapanel Plus is ideal for use in wet and high humidity situations. One side is prepared as a key for adhesive, the other side is fair faced. Long term performance is not dependent on grouting or finishing. Aquapanel Plus can be used to support tiling for splashbacks, bath surrounds and shower enclosures.

- D8003008 - 1200 x 900 x 12.5mm
- D8003010 - 1200 x 2400 x 12.5mm
- D8003004 - 40mm Screws (100 per pack)

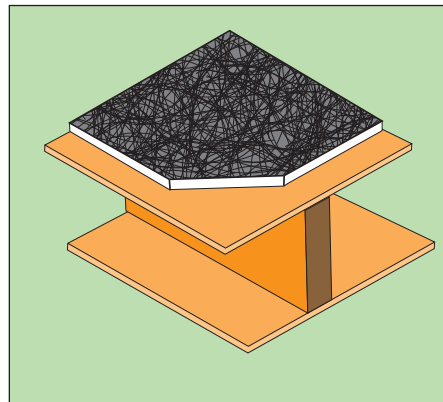

### FLOOR UNDERLAY

Aquapanel Plus is ideal for use in wet and high humidity situations. One side is prepared as a key for adhesive, the other side is fair faced. Long term performance is not dependent on grouting or finishing. Aquapanel Plus can be used to support tiling for splashbacks, bath surrounds and shower enclosures.

## Warmup Undertile Heating

Warmup's Undertile Heating System is the perfect add-on product for tile, conservatory, bathroom and kitchen sales.

The heater is simply taped to the subfloor before tiling. The 2mm wire will not raise floor levels and can be fitted into any shaped room regardless of fixtures.

The BEAB approved Warmup heating element is fully screened and comes with a 10 year guarantee.

The heaters are controlled by Warmup's 16 amp programmable timer/thermostat (TSTAT). Each thermostat comes with a remote floor probe for accurate control of floor temperature.

### FOUR SIMPLE STEPS TO LUXURIOUS WARMTH



1 Paint subfloor with Primer



2 Lay out heating element



3 Connect Warmup Thermostat



4 Apply adhesive & tile over

### TYPICAL INSTALLATION

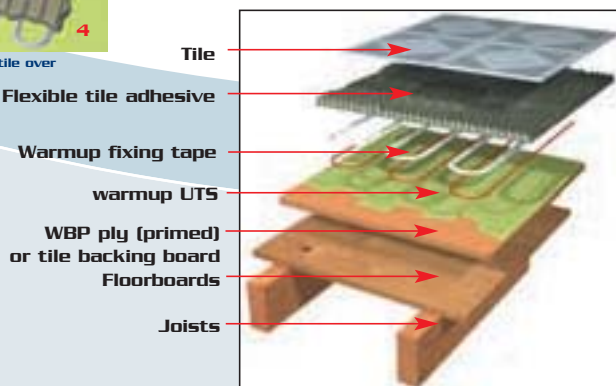

- N2539006 - UTS300 - 300 Watt Undertile Heater
- N2539003 - UTS400 - 400 Watt Undertile Heater
- N2539004 - UTS800 - 800 Watt Undertile Heater
- N2539007 - Programmable Timer/Thermostat with Floor Probe
- N2539005 - 16 amp Electronic Thermostat with Floor Probe

Net Area To be Heated (m <sup>2</sup> )	kw	Heaters and Therostats Required
1.5 - 2.4	0.3	1 x UTS300 Warmup Undertile Heater 1 x Thermostat
2.5 - 3.4	0.4	1 x UTS400 Warmup Undertile Heater 1 x Thermostat
3.5 - 4.4	0.6	2 x UTS300 Warmup Undertile Heater 1 x Thermostat
4.5 - 6.9	0.8	1 x UTS800 Warmup Undertile Heater 1 x Thermostat
7.0 - 8.3	1.2	1 x UTS400 Warmup Undertile Heater 1 x UTS800 Warmup Undertile Heater 1 x Thermostat
8.4 - 11.0	1.6	2 x UTS800 Warmup Undertile Heater 1 x Thermostat
11.1 - 13.7	2.0	1 x UTS400 Warmup Undertile Heater 2 x UTS800 Warmup Undertile Heater 1 x Thermostat
13.8 - 18.0	2.4	3 x UTS800 Warmup Undertile Heater 1 x Thermostat
18.1 - 20.7	2.8	1 x UTS400 Warmup Undertile Heater 3 x UTS800 Warmup Undertile Heater 1 x Thermostat
20.8 - 25.0	3.2	4 x UTS800 Warmup Undertile Heater 1 x Thermostat
25.1 - 27.7	3.6	1 x UTS400 Warmup Undertile Heater 4 x UTS800 Warmup Undertile Heater 2 x Thermostat
27.8 - 32.0	4.0	5 x UTS800 Warmup Undertile Heater 2 x Thermostat

## Nicobond Epsom Range



The Nicobond Epsom Range of real wood flooring creates a floor that provides timeless elegance and creates beauty and warmth with durability easy maintenance and healthy living.

This attractive floor made from 100% natural materials can be chosen with confidence as Nicobond Epsom has the smoothest finish available due to the near perfect fit created from a precision milling process. The quality of the manufacturing and drying process gives a 3 ply parquet excellent dimensional geometric stability and provides good sound installation when installed with Nicobond cell foam underlay.

- Tough and durable
- 4mm solid hardwood surface
- Restorable if required
- Easy to install
- Precision engineering
- Warm and beautiful

# Wood Flooring

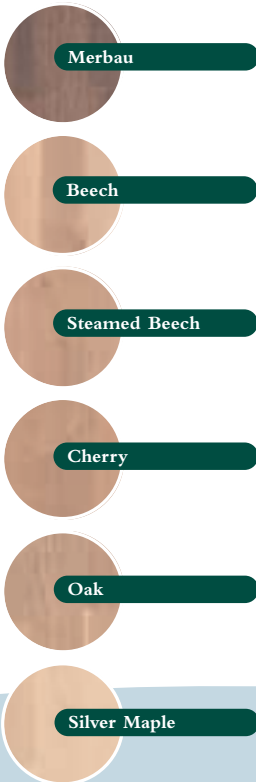

### EPSOM 3 STRIP HARDWOOD FLOORING

A 3 Strip Solid hardwood Surface 4mm thick with laquered finish.

- F1690200 - Beech
- F1690202 - Oak
- F1690204 - Steamed Beech
- F1690206 - Silver Maple
- F1690208 - Merbau

### EPSOM OILED 3 STRIP HARDWOOD FLOORING

All the benefits of the 3 strip flooring but the oiled version has a more natural or rustic appearance. The Soft natural Sheen combines perfectly with other aged materials/finishings.

- F1690230 - Beech
- F1690232 - Steamed Beech
- F1690234 - Oak

### EPSOM PLANK HARDWOOD FLOORING

plank effect hardwood flooring consists of a single piece hardwood top, laquered for a tough and durable finish.

- F1690216 - Beech
- F1690214 - Steamed Beech
- F1690212 - Oak

### EPSOM SOLID TIMBER & REAL WOOD VENEER SKIRTING 2.7 METRES

- F1690302 - Beech
- F1690304 - Oak
- F1690300 - Maple
- F1690308 - Merbau
- F1690306 - Cherry



### EPSOM HARDWOOD PIPEWORK COVERS

- F1690320 - Beech
- F1690322 - Oak
- F1690324 - Maple

### EPSOM HARDWOOD STRIP (T-THRESHOLD)

- F1690330 - Beech
- F1690332 - Maple
- F1690334 - Oak

### EPSOM SQUARE FRONT EDGING 2.1 METRE LENGTHS

- F1690340 - Beech
- F1690342 - Maple
- F1690344 - Oak

### NICOBOND CELLFOAM UNDERLAY 25M X 1100MM = 27.5 M<sup>2</sup>

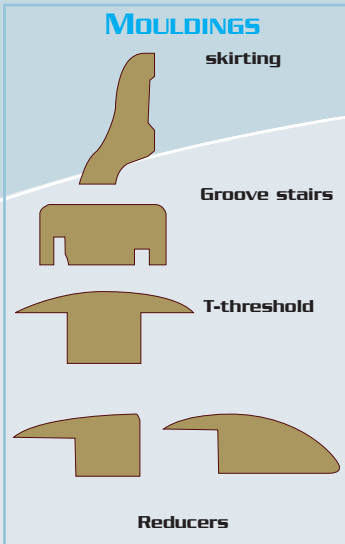

- 2200 x 205 x 15mm • Wear Layer 4mm • 8 Boards per Pack • 30 Packs per pallet = 108m<sup>2</sup>

Guaranteed for 20 years from date of delivery. The Guarantee is limited to faults that have been caused during manufacturing.

For more information go to [www.barbourproductsearch.info](http://www.barbourproductsearch.info)

**N&C Express Collect**

SANITARYWARE ● IRONMONGERY ● KITCHENS ● TILES AND DECORATING ● PHLEXICARE

**PHONE/FAX: 020 7247 0333**

**No Queues ● Don't wait for it ● Express Collect**

- ALL PHONE/FAX ORDERS READY FOR COLLECTION IN ONE HOUR
- PLACE YOUR ORDER BY 4.30PM READY FOR COLLECTION BY 8.00AM
- OVER 40,000 PRODUCT LINES IN STOCK
- EXPERT HELP ON HAND
- LARGE CAR PARK
- FREE TEA/COFFEE
- FREE DELIVERY SERVICE ALSO AVAILABLE

# Express Collect

3-10 Shoreditch High Street, London E1 6PE

Phone/fax: 020 7247 0333

FREE DELIVERY ● FREE CAR PARK ● FREE DELIVERY ● FREE CAR PARK ● FREE DELIVERY



N&C Locations

N&C

Nicholls & Clarke  
Group of Companies

N&C  
Building Materials



41-51 Freshwater Road, Chadwell Heath  
Romford, Essex RM8 1SP  
Tel: 020 8586 4600 Fax: 020 8586 4646

N&C  
Glass



N&C Glass London, Unit 27, Gemini Business  
Park, Hornes Way, Beckton, London E8 7FF  
Tel: 020 7473 0999 Fax: 020 7476 1017

28 Barnes Wallis Road  
Fareham, Hampshire PO15 5TT  
Tel: 01489 589858 Fax: 01489 574474

N&C  
Nicobond

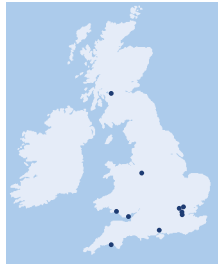

Units B1-B3  
Sneyd Trading Estate, Sneyd Hill, Burslem  
Stoke-on-Trent ST6 2PA  
Tel: 01782 575727 Fax: 01782 575641

41-51 Freshwater Road, Chadwell Heath  
Romford, Essex RM8 1SP  
Tel: 020 8586 4600 Fax: 020 8586 4646

325-327 Penarth Road  
Cardiff CF11 8TT  
Tel: 029 2039 0146 Fax: 029 2022 4356

Unit 5, Tower Court,  
St. David's Road  
Swansea Enterprise Park,  
Swansea SA6 8QL  
Tel: 01792 797337 Fax: 01792 774019

Unit 4, Waterloo Industrial Estate  
Flanders Road Hedge End  
Southampton SO30 2QT  
Tel: 01489 779700 Fax: 01489 779701

Unit C1, Cothill Industrial Estate  
Plympton, Plymouth PL7 1SR  
Tel: 01752 339724 Fax: 01752 342746

26 Colquhoun Avenue  
Hillington Industrial Estate  
Hillington, Glasgow G52 4BN  
Tel: 0141 880 1200 Fax: 0141 880 1212

Unit 14, Meridian Trading Estate,  
Bugsby Way, Charlton, London SE7 7SJ  
Tel: 020 8269 5960 Fax: 020 8269 5961

Unit 8, Ascent Park  
Edinburgh Way, Harlow, Essex CM20 2HW  
Tel: 01279 621980 Fax: 01279 621981

Units 1 A/B  
Alexander Place, Lower Park Road  
New Southgate, London N11 1ST  
Tel: 020 8361 6050 Fax: 020 8361 4757

Amicable Street  
Burslem, Stoke-on-Trent ST6 3BJ  
Tel: 01782 833330 Fax: 01782 834225

N&C  
Tile Style



Unit 14, Meridian Trading Estate,  
Bugsby Way, Charlton, London SE7 7SJ  
Tel: 020 8269 5960 Fax: 020 8269 5961

Unit 8, Ascent Park  
Edinburgh Way, Harlow, Essex CM20 2HW  
Tel: 01279 621980 Fax: 01279 621981

Units 1 A/B  
Alexander Place, Lower Park Road  
New Southgate, London N11 1ST  
Tel: 020 8361 6050 Fax: 020 8361 4757

41-51 Freshwater Road, Chadwell Heath  
Romford, Essex RM8 1SP  
Tel: 020 8586 4600 Fax: 020 8586 4646

325-327 Penarth Road  
Cardiff CF11 8TT  
Tel: 029 2039 0146 Fax: 029 2022 4356

Unit 5, Tower Court,  
St. David's Road  
Swansea Enterprise Park,  
Swansea SA6 8QL  
Tel: 01792 797337 Fax: 01792 774019

Unit 4, Waterloo Industrial Estate  
Flanders Road Hedge End  
Southampton SO30 2QT  
Tel: 01489 779700 Fax: 01489 779701

Unit C1, Cothill Industrial Estate  
Plympton, Plymouth PL7 1SR  
Tel: 01752 339724 Fax: 01752 342746

Unit 10 Centre, Motherwell  
Way, West Thurrock, Essex. RM20 3LE  
Tel: 01708 680180 Fax: 01708 680181

Unit 16, Arlington Business Park,  
Whittle Way, Stevenage, Herts. SG1 2BD  
Tel: 01438 315400

N&C  
Moderna



41-51 Freshwater Road, Chadwell Heath  
Romford, Essex RM8 1SP  
Tel: 020 8586 4600 Fax: 020 8586 4646

**Other Publications**

If you would like any other publication from the N&C Group of Companies please contact the Sales and Marketing Department on:  
**Tel: 020 7247 5432**  
**Fax: 020 7247 7738**  
[www.nichollsandclarke.com](http://www.nichollsandclarke.com)

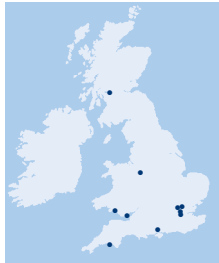

3-10 Shoreditch High Street  
 London E1 6PE  
 Tel: 020 7247 5432 Fax: 020 7247 7738

Units B1-B3  
 Sneyd Trading Estate, Sneyd Hill, Burslem  
 Stoke-on-Trent ST6 2PA  
 Tel: 01782 575727 Fax: 01782 575641

Unit 5, Tower Court,  
 St. David's Road  
 Swansea Enterprise Park,  
 Swansea SA6 8QL  
 Tel: 01792 797337 Fax: 01792 774019

325-327 Penarth Road  
 Cardiff CF11 8TT  
 Tel: 029 2039 0146 Fax: 029 2022 4356

Unit 4, Waterloo Industrial Estate  
 Flanders Road Hedge End  
 Southampton SO30 2GT  
 Tel: 01489 779700 Fax: 01489 779701

Unit C1, Cothill Industrial Estate  
 Plympton, Plymouth PL7 1SR  
 Tel: 01752 339724 Fax: 01752 342746

Unit B, Ascent Park  
 Edinburgh Way, Harlow, Essex CM20 2HW  
 Tel: 01279 621980 Fax: 01279 621981

Unit 14, Meridian Trading Estate,  
 Bugsby Way, Charlton, London SE7 7SJ  
 Tel: 020 8269 5960 Fax: 020 8269 5961

Units 1 A/B  
 Alexander Place, Lower Park Road  
 New Southgate, London N11 1ST  
 Tel: 020 8361 6050 Fax: 020 8361 4757

1 Piccadilly Street, Glasgow G3 8DR  
 Tel: 0141 248 5355 Fax: 0141 221 9274

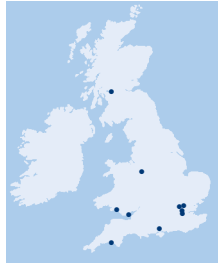

Unit C1, Cothill Industrial Estate  
 Plympton, Plymouth PL7 1SR  
 Tel: 01752 339724 Fax: 01752 342746

Unit 5, Tower Court,  
 St. David's Road  
 Swansea Enterprise Park,  
 Swansea SA6 8QL  
 Tel: 01792 797337 Fax: 01792 774019

Units B1-B3  
 Sneyd Trading Estate, Sneyd Hill, Burslem  
 Stoke-on-Trent ST6 2PA  
 Tel: 01782 575727 Fax: 01782 575641

325-327 Penarth Road  
 Cardiff CF11 8TT  
 Tel: 029 2039 0146 Fax: 029 2022 4356

Units 1 A/B  
 Alexander Place, Lower Park Road  
 New Southgate, London N11 1ST  
 Tel: 020 8361 6050 Fax: 020 8361 4757

Unit 4, Waterloo Industrial Estate  
 Flanders Road Hedge End  
 Southampton SO30 2GT  
 Tel: 01489 779700 Fax: 01489 779701

1 Piccadilly Street, Glasgow G3 8DR  
 Tel: 0141 248 5355 Fax: 0141 221 9274

Unit B, Ascent Park  
 Edinburgh Way, Harlow, Essex CM20 2HW  
 Tel: 01279 621980 Fax: 01279 621981

Unit 14, Meridian Trading Estate,  
 Bugsby Way, Charlton, London SE7 7SJ  
 Tel: 020 8269 5960 Fax: 020 8269 5961

3-10 Shoreditch High Street  
 London E1 6PE  
 Tel: 020 7247 5432 Fax: 020 7247 7738



**N&C Group of Companies**



## Sanitaryware, Kitchens and Castings

Air Admittance Valves	313	Duo Range	66	Gutter Brackets	296, 297
Air Bag Stopper	237	Fairline Range	179	Hand Driers	52, 224
Anti Vandal Toilet Roll Holder	224	Jade Range	54	Harmer Drains	292
Anti-Vandal Taps	183	Jetline Range	181	Heated Towel Rails	238, 239
Appliances		Kingston Range	182	Hemp	236
Baumatic	277	Marbles Range	63	In Wall Flushing Systems	148, 149
Candy	274, 275	Nova Diamante Range	58	Isolating Valves	231
Electrolux	276	Nova Palma Range	57	Janitorial Unit	250
Neff	277	Nova Simplicity Range	59	Jubilee Clips	236
Phlexicare	128	Novalever Range	60	Kitchen Accessories	281
Rosieres	277	Novaturn Range	61, 62	Kitchen Furniture	
Audio Visual Alarm	52	Pelican Range	65	Broadgate City Range	256, 257
B.S.S. Sanitaryware	138, 140	Victorian Range	180	Country Range	258
Baby Changing	109	Waterways Range	182	Highland Range	260
Back Plate Elbow	231	Bronze & Silver Specification	262, 263	Lakeland Range	261
Ball Floats	231	Bucket Sinks	41, 194, 249	Moorland Range	259
Bar Sinks	253	C.A.D Design Service	269	Opera Range	265
Basin		Caraflo Roof Outlets	313	Phlexicare	116, 127
Adjustable Height	47, 106	Cast Iron		Kalvodos Range	264
Beaumonde	47	Ensign Soil and Drain	305, 308	Scope Maple Range	264
Brackets and Stands	141	Rainwater and Gutter	293, 296	Scope Montana Range	265
Corner	20, 37, 38	Timesaver Soil and Drain	297, 304	Solway Range	266
Inset	20, 146	Catering Sinks	252	Kitchen Lighting	280
Range Form	244	Catering Tables	253	Lead Flashing	313
Shampoo	46	Channel Gratings	291, 292	Legs and Bearers	41, 194
Stainless Steel	244, 245	Check Valves	230, 231	Level Dec Showering	89, 90
Under Counter	22, 147	Childrens Cubicles	176	Lever Conversion Kits	62
Wall Hung	21, 25, 34, 36, 37, 45, 145	Cisterniser	192	Lifting and Handling	131, 132
Bath Panels		Cisterns Concealed	26, 144	Manhole Covers and Frames	284, 287
Acrylic	16, 137	Cisterns Exposed	143	Manhole Grease	287
Hardboard	137	Cleaners Sink	41, 194, 249	Manhole Lifting Keys	287, 288
Solid Wood	137	Cleaning Rods	237	Mini Kitchens	278, 279
Bath Screens	203	Coal Plates and Frames	313	Mirrors	314
Bath Seats	74	Cold Caulking	313	Multikwiks	152
Bathroom Accessories		Copper Fittings	232, 234	Nappy Disposal Machine	251
Aqua Range	217	Copper Tube	232	Non, Concussive Taps	183
Astoni Range	214	Dispensers		P.T.F.E. Tape	236
Ceramic Range	221	Automatic	224	Pet Cock	231
Economy Range	219, 220	Soap	52, 224, 225	Phlexiscreen	93
New Wave Range	216	Stainless Steel	226	Plastic Pipe and Fittings	
Sienna Range	218	Tissue	52, 225	Terrain Overflow	311, 312
Urban Spa Range	215	Towel	52, 225	Terrain Rainwater	312, 313
Bathroom Cabinets	223	Document 'M'	48-51	Terrain Soil	308, 310
Bathroom Furniture	165, 166	Drain Testers	237	Terrain Waste	310, 311
Bathroom Suites		Drain Testing Plug	237	Plastic Push Fit Tube and Fittings	235
Broadgate Range	31, 34	Drinking Fountains	187, 250	Pressalit Multi System	100, 105
Designer Range	27, 30	Duofix	148, 149	Pressflo Basin Waste	107
Duchess Range	160	Electrathern	94	Pumped Waste Systems	90, 92
Modern Range	17, 22	Flexible Connectors	236	Ropox	129, 130
Princess Range	160	Flexible Couplings	313	Rubber Plungers	237
Reflections Range	158, 159	Flexible Plumbing Kit	107	Salt Tablets	237
Sandringham Range	164	Float Valves	152, 231	Saniflo	188, 189
Space Range	161, 163	Flush Fit Showering	85, 88	Sanitary Towel Dispenser	251
Studio Range	156, 157	Flush Pipes and Cones	151	Sash Weights	292
Wall Hung Range	23, 26	Flux	234, 236	Scale Reducer	237
Baths		Folding Grab Rails	114, 115	Sealing Plates and Frames	290
Acrylic	5, 9	Force Cups	237	Sensorflow	184, 186
Cast Iron	136	Fresh Air Inlet	313	Shelf Sink	194
Luxury Acrylic	10, 15	Full Bore Crystals	236	Shower Accessories	213
Phlexicare	68, 73	Gate Valves	230, 234	Shower Bench	98
Steel	135, 136	Glass Bowls	168, 169	Shower Chairs	99
Belfast Sinks	41, 194	Glass	314	Shower Curtains	211
Bending Springs	236	Gold Specification	267	Shower Doors Phlexicare	82, 84
Bib Taps	180, 230	Grab Rails		Shower Enclosures	
Block Paviours	287	Astral	111, 113	Calista Range	199, 202
Blow Lamp	236	Nova	111, 113	Chiara Range	198
Brassware		Pressalit	110, 111	Phlexicare	75, 78
Athena Range	55, 56	Safegrip	110	Star Range	196, 197
Club Range	179	Titan	111, 113	Shower Kits	208
Cross Head Range	180	Gully Gratings and Frames	288, 290	Shower Loo	150
Duet Range	64		291, 292	Shower Pumps	205, 208

## Sanitaryware, Kitchens and Castings

Shower Seats	96, 98	Surface Boxes	290, 291	W.C. Connectors	152
Shower Trays		Tap Wrench	237	W.C. Pan	
Acrylic	195	Taps and Mixers	54, 66, 179, 186	Asian	42
Fireclay	195	Tarred Gaskin	236	Raised Height	44, 45
Phlexicare	75, 81, 85, 90	Thermostatic Valves and Mixers	106, 183	Turned Trap	142
Resin Stone	195	Throne Grab Rail	45	Two Piece	142
Showers		Toilet Cubicles	170, 178	Back to Wall	36, 142, 19
Commercial	210	Toilet Seats Phlexicare	108	Childrens	42, 142
Electric	204, 205	Toilet Seats	153, 154	Stainless Steel	246
Healthcare	205	Trapeze Lifts	74	Wall Hung	24, 142
Manual Mix	207, 208	Traps	229	Wash Troughs	250
Phlexicare	93, 95	Tube Cutters	236	Washers	236
Thermostatic	207, 209	Turbo Syphon	152	Washing Machine Valves	230
Sink Tops		Urinal Bowls	38, 39, 40	Washroom Systems	170, 178
Ceramic	273	Urinal Fittings	193	Waste Cleaners	237
Granite	273	Urinal Pipes and Spreaders	192, 193	Wastes	228
Phlexicare	129	Urinal Syphons	193	Water Heaters	240, 241
Stainless Steel	270, 272	Urinal Treads	192	Water Softeners	237
Solder Wire	234	Urinals		Water Tanks	242
Spatulate Lever	52	Fireclay	191	Wire Balloons	313
Stainless Steel Bowls	249	GRP	191	Wire Wool	234
Stainless Steel Tube	232	Stainless Steel	247, 248	Worktop Jointing Strips	268
Step Irons	287	Waterless	190	Worktops	268
Stop Cocks	230, 234	Utility Sinks	249		
Strap on Boss	313	Vanity Units	167		

## Ironmongery

Acorn Sash Stops	484	Centre Door Knobs	319, 333, 344	Dust Excluding Sockets	464
Adjustable Shelving	502, 503	Chain Link Fencing	528, 529	Dustbins	520
Air Bricks	528	Chains & Fittings	530	Ear Protectors	525
Anti Ligature Furniture	398	Chalk Lines	524	Electric Strikes	447
Arris Rail Brackets	529	Check Chains	411	Electric Window Openers	489
Ashtrays	533	China Door Furniture	341	Emergency Door Stops	463
Assaflex Window Stays	482	Chisels	523	Endless Cord	483
Automatic Door Openers	386, 387	Chubb	421	Escape Deadlocks	470
Axle Pullies	485	Cleat Hooks	329, 483	Escutcheons	319, 333, 339, 342, 362, 364, 367, 370, 372, 373, 374, 379, 415
Ball Bearing Hinges	385	Clothes Airers	531	Euro Profile Cylinders	383, 423
Ball Catches	416	Coach Bolts	510	Euro Profile Locks	383
Banjo Shelf Studs	506	Coach Screws	509	Extension Ladders	526
Barbed Wire	529	Collinge Hinge	452	Facility Indicator Bolt	467
Barrel Bolts	327, 334, 343, 464, 466	Concealed Hinge	492	Falling Butt Hinges	449
Barrier Systems	518	Continuous Hinge	450	Fanlight Catch	326, 483
Bathroom Bolts	328, 336	Corner Braces	516	Fanlight Openers	483
Bathroom Locks	347, 348, 382, 418, 420	Corner Protectors	403	Fencing & Fittings	528, 529
Beclawat Sash Balances	487	Counter Flap Catches	450	Field Gate Hinge	452
Bell Pushes	320, 333, 342	Counter Flap Hinge	385, 449	Field Gate Latch	452
Bicycle Racks	533	Cubicle Fittings	491	Finger Plates	322, 341, 343, 371, 372, 373, 375, 379, 403, 379, 403
Bicycle Shelters	533	Cup Hooks	515	Finger Pull	485
Bird Ban	518	Cupboard Catch	329, 335, 417	Finprotect	501
Black Antique Furniture	342, 343, 344, 345	Cupboard Knobs	341, 353, 371, 376, 408	Fire Blanket	479
Blind Cord	486	Cupboard Locks	415	Fire Brigade Locks	445
Block Connectors	516	Curtain Hooks	490	Fire Bucket	479
Bollards	532, 533	Curtain Rails & Fittings	490	Fire Door Controls	471
Bolt Plates	464	Curtain Wire	490	Fire Extinguishers	479
Bolt Sockets	454, 464, 466	Cylinder Pull	320, 333, 339, 371	Fischer Fixings	511, 512, 513, 514
Bolts & Nuts	510	Dead Locks	348, 382, 383, 384, 418, 420, 421, 423	Floor Springs	463
Bookcase Strip	506	Dexion Shelving	508	Flush Bolts	371, 372, 373, 376, 381, 465
Brentons Pad Bolts	466	Dictator Door Check	457	Flush Handles	408, 409
Budget Locks	415	Digital Locks	442, 443	Flush Lifts	485
Butt Hinges	448, 449, 450, 451	Door Bells	407	Flush Mounts	516
Cabin Hooks	329, 335, 344, 411	Door Bolts	327, 343	Flymesh	414
Cabinet Connectors	492	Door Catches	326	Forks	524
Cabinet Fittings	353, 354, 408	Door Chains	329, 335	Foundation Bolts	510
Cabinet Locks	415	Door Closers	457, 458, 459, 460, 461, 462	Frame Fixings	511
Cable Locks	438	Door Holders	410	Friction Stays	482
Cable Ties	516	Door Knockers	320, 333, 343	Garage Door Bolts	453, 454
Card Frames	408	Door Pivots	463	Garage Door Fittings	453
Casement Bolts	358	Door Springs	457	Garage Door Holders	453
Casement Fasteners	324, 334, 340, 345, 355, 481	Door Stops	329, 335, 339, 371, 376, 381, 410	Garage Doors	455
Casement Stays	325, 334, 340, 345, 355, 480	Door Viewers	333, 433, 434	Gate Catches	453
Castors	517	Draught Excluders	499, 500, 501	Gate Closer	456
Cavity Fixings	511	Drawer Pulls	335, 354, 408		
Cellar Flap Hinge	452	Drawer Runners	492		
		Drywall Screws	509		

Ironmongery	
Gate Catches	453
Gate Closer	456
Gate Fittings	453
Gate Posts	456
Gate Springs	453
Gate Stop	453
Gates	456
Gibraltar Door Spring	457
Glass Shelves	506
Gloves	525
Hammers	523
Handrail	537
Handrail Brackets	323, 413
Hanging Basket Bracket	507
Hanging Rail	352
Hasps & Staples	440, 441
Hat & Coat Hooks	323, 335, 339, 344, 371, 376, 381, 412, 413
Hawgoods Spring Hinge	457
Hewi	400
Hinge Bolts	432, 433
Hinge Front	345
Hinges	344, 345, 349, 350, 351, 385
Hook & Ride Hinges	452
Horizontal Mortice Lock	418, 423
Indicator Bolts	328, 336, 339, 344, 370, 467
Intercom Systems	446, 447
Intumescent Materials	478
Kee Klamp Fittings	536, 537
Key Blanks	346, 429
Key Boxes	479
Key Cabinets	406
Key In Knob Set	444
Key Tags	406
Kicking Plates	371, 372, 373, 376, 403
Knives	523
Knob Furniture	319, 332, 338, 341, 377, 398
Ladder Bracket	507
Ladders	526, 527
Latch Handle	345
Letter Plates	321, 333, 340, 343, 376, 404
Letter Tidy	321, 333, 404
Lever Furniture	316, 317, 318, 330, 331, 332, 337, 338, 342, 360, 361, 363, 365, 366, 368, 370, 372, 373, 374, 377, 378, 397, 398, 421, 422
Lifting Platforms	393
Line Posts	531
Line Pullies	531
Lockable Fasteners	355
Lockable Stays	355
Locker Systems	521
Locking Bars	440, 441
Loft Ladders	527
Magnetic Catches	416
Magnetic Door Holders	471
Magnetic Locks	447
Mailsafes	388
Matting	519
Matwell Frames	519
Meakins Sash Opener	487
Measuring Tapes	524
Medicine Cabinets	406
Melamine Board	506
Microwave Brackets	507
Mirror Plates	515
Mirror Screws	509
Module 1200	424, 425, 426, 427
Mortice Dead Locks	348, 382, 383, 384, 418, 420, 421, 423
Mortice Latch	382, 417, 420, 421
Mortice Locking Latch	421, 422
Mortice Locks	348, 382, 383, 384, 418, 420, 421, 422
Mortice Nightlatch	383, 419
Mortice Sash Locks	348, 382, 383, 384, 418, 420, 423
Moulding Hooks	515
Multipoint Locks	441
Nails	510
Normbau	400
Notice Boards	518
Numerals	320, 333, 344, 407
Oval Profile Cylinders	384, 419, 423
Oval Profile Locks	384, 419
Overalls	525
Padbolts	466
Padlock Bars	440, 441
Padlocks	437, 438, 439
Panel Pins	510
Panic Bolts & Latches	468, 469
Parking Posts	534
Parliament Hinges	448, 449
Perko Door Closers	457
Piano Hinge	450
Pictograms	381, 474
Picture Hooks	515
Picture Wire	515
Pivot Hinges	482
Plasterboard Fixings	511
Pliers	523
Pole Hooks	483
Ponte Gulio	391
Portable Ramps	392, 393
Postal Boxes	405
Postal Knockers	321, 333, 343, 404
Power Supplies	447
Projection Hinges	385
Pull Handles	322, 335, 340, 343, 371, 372, 373, 375, 380, 399, 402
Quadilent Stays	482
Radar Locks	390
Radiator Grilles	357
Rail Fittings	352
Ramp Systems	394
Rebate Kits	382, 384
Redlam Bolt	470
Repair Plates	516
Resin Fixings	514
Restrictor Stays	434, 482
Reversible Hinges	451
Rim Cylinders	346, 429
Rim Dead Lock	428
Rim Latch	347, 428
Rim Lock	347, 428
Rim Nightlatches	346, 428, 429, 431
Rising Butt Hinges	448, 449
Roller Bolt Catch	347
Roller Catches	416
Safety Equipment	525
Safety Goggles	525
Safety Helmets	525
Safety Spectacles	525
Sash Pivots	484
Sash Chains	486
Sash Cord	486
Sash Eye	484
Sash Fasteners	326, 334, 340, 484
Sash Handle	485
Sash Lifts	326, 334, 335, 340, 484
Sash Locks	348, 382, 383, 384, 418, 420, 423
Sash Roller	484
Sash Screw	484
Sash Stops	484
Saws	524
Screw Caps	515
Screw Cups & Sockets	515
Screw Hooks	515
Screwdrivers	524
Screws	509
Security Bolts	328, 336, 432
Security Chain	438
Security Fittings	432, 433, 434, 435, 436
Security Mirrors	535
Shelf Brackets	504, 505
Shield Anchor Bolts	513
Shovels	524
Signs	472, 473, 474, 475, 476, 477
Sleeve Anchors	513
Sliding Door Gear	494, 495, 496, 497, 498
Sliding Door Lock	418, 418, 420, 423, 492
Sliding Door Track	493
Smoke Alarms	479
Snowguard	528
Soss Hinges	450
Speed Ramps	535
Spindles	398
Spiral Sash Balances	487
Spirit Levels	524
Spring Hinges	385
Spur Shelving	502, 503
Squash Court Handle	409
Steel Anchors	512
Stepladders	527
Strap Hinges	451
Table Plates	516
Tee Hinges	451
Television Brackets	507
Tell Tales	524
Toggle Fixings	511
Tool Hooks	507
Tools	522, 523, 524, 525
Tree Grilles	532
Trestle Joints	449
Tubular Latches	347
Turn & Release	362, 364, 370, 372, 373, 374, 379
Union Locks	418, 419
Vent-A-Matic	414
Ventilators	356, 414
Video Bracket	507
Wallplugs	511
Wardrobe Rail	352
Water Butts	520
Wheel Clamps	535
Window Winding Gear	488
Wire Netting	529
Wooden Dowels	492
Wooden Poles	483
Worktop Clamps	492

**Decorating Products, Nicobond Tiles and Adhesives**

Adhesives		Metal Finishes	547, 548	Stabilising Solution	
Evode	578	Mops	575	Macphersons	544
Laybond	578	Natural Stones	583	Sandtex	545
Nicobond	594	Paint & Varnish Removers	557	Step Ladders	568
Brick Cleaner	572	Paint Brushes		String	567
Brooms	574	Hamilton	563	Sugar Soap	571
Brush Restorer	556	N&C	563	Surface Sealers	562
Brushmate	566	Paint Kettles & Scuttles	566	Tapes	567, 568
Buckets	567	Paint Rollers	564	Tapes, Anti Slip	562
Cements	593	Paints, Anti Climb	546	Tarpaulins	568
Chemicals	573	Paints, Exterior & Masonry		Thinners	
Cleaning Crystals	592	Crown	542	Coovar	546
Construction & Repair Products	561	Dulux	541	Hammerite	547
Decorating Tools	565	Rustins	553	Rustins	556
Decorators Filler	576, 577	Sandtex	545	Tile Adhesive & Grout	585
Degreasers	562	Paints, Flame Retardant	543	Tile Adhesive & Grout Additives	589
Detergents	572	Paints, Interior		Tile Adhesives	584, 585, 586
Dust Sheets		Crown	541, 542	587, 588, 589	
Polythene	567	Dulux	540	Tile Backing Boards	599
Twill	567	Hammerite	547, 548	Tile Cutters	596
Enamels	547	Macpherson	544	Tile Heating Systems	599
Enhancer	589	Rustins	553	Tile Trims, Seals & Joints	597, 598
Epoxy Grout	589, 590	Pitch Screed	593	Tiles	
Fillers		Pointing Mortar	589	Easicare	583
Dulux	541	Polishes	554	Porcelain	583
Nicobond	577	Polythene Builders Film	568	Wall	582, 583
Sandtex	545	Primers		Floor	583
Tetrion	570	Coovar	546	Tiling Tools	595
Fitches	563	Crown	543	Undertile Heating	599
Flexible Tile Adhesive	586, 587	Dulux	540	Varnishes	
Floor Paints		Hammerite	547	Ronseal	550, 551, 552
Anglo	561	Macpherson	544	Rustins	555, 556
Coovar	546	Nicobond	593	Wallpaper Adhesives	569
Flooring, Wooden	600	Rustins	553	Waterproofing	
Foam Filler	578	Sandtex	545	Ruberoïd	559
Fungicidal Solution		Zinsser	547	Aquaseal	558, 560
Crown	542	Putty	578	Thompsons	559
Dulux	541	PVA	593	Wax	556
Sandtex	545	Refuse Sacks	568	White Spirit	566
Gap Filler / Adhesive	577	Render Improver	594	Window Cleaning Supplies	575
Glasspaper	569	Road Line Paint	546	Wire Brushes	564
Granite Chippings	592	Rollers, Sleeves & Trays	564	Wood Polishes & Oils	555
Grout Dyes	590	Roof Repair		Wood Preservers, Dyes & Treatments	
Grouts	589, 590	Anglo	562	Ronseal	551, 552
Hammerite	547, 548	Aquaseal	559	Rustins	554
Hand Cleaners	572	Rubble Sacks	568	Saddolin	549
Hydrochloric Acid	572	Screeds	590, 591	Sikkens	550
Janitorial Supplies	571, 572, 573, 574, 575	Sealants		Wooden Flooring	600
Lining Paper	569	Dow Corning	576, 577	Woodfiller	556
Louvre Blades	579	Nicobond	594	Woodworking Adhesives	
Louvre Accessories	580	Sealant Remover	577	Evode	578
Lubricants		Skeleton Gun	577	Nicobond	594
3 In One	572	Solar Reflective Coatings			
WD40	572	Coovar	546		
Marble & Granite Adhesive	587	Thompsons	559		
Masking Tape	567	Sponges	571		



## Terms & Conditions of Sale for N&C Group of Companies

Acceptance by us of your order is conditional upon acceptance by you of the following conditions, which over-ride all other terms and conditions inconsistent herewith. No variation to these conditions shall be binding upon us unless accepted by us in writing.

### 1. Prices

- Prices charged will be those ruling at date of despatch.
- In the event of your cancelling a part of the order in accordance with the provisions of Condition 3 hereof we reserve the right to revise the price or prices quoted.

### 2. Orders and Quotations

When ordering please quote catalogue references, quantities, size and finish. Samples submitted or illustrations or descriptions given in catalogues, trade literature or quotations must be considered as showing type or class only without warranty as to substance, performance, colour, size or shape.

Quotations which comprise an invitation to treat may be withdrawn at any time before receipt of your offer to purchase and shall be deemed to be withdrawn if such is not received within 30 days from the date of quotation.

Quotations are based upon prices applicable to quantities specified. In the event your order is for a lesser quantity we shall be entitled to adjust the price of the goods as ordered to take account of the variation in quantity.

### 3. Cancellations

No cancellation of the whole or any part of any order is permitted except where expressly agreed by us in writing. In the event of such agreed cancellation you shall indemnify us fully against all expenses incurred as a result of such cancellation. In any case in which we are required to place a deposit with a manufacturer or supplier in respect of your order then we may require you to reimburse us with this sum in the event of your cancellation of the order or any part thereof. Where cancellation involves goods designed, made or ordered specially for you then you will be liable for any costs incurred by us in respect of such cancellation. Any goods returned to us for credit shall be accepted by us only if the same are in good condition.

### 4. Packages

Where chargeable packages are returnable they will be credited if returned to us carriage paid and in good condition within 60 days. Identification should be attached and advice sent to Head Office. After a lapse of 90 days from date of invoice no credit will be allowed.

### 5. Export

Special prices and conditions are quoted for all export orders.

### 6. Terms Strictly Nett Cash

- Credit accounts which are strictly due within 30 days following the month of delivery may be opened at our discretion and subject to satisfactory trade references and to the observance by the customer of the credit terms. In the event of non-payment in accordance with the credit terms or if accounts exceed credit limits the whole price for goods delivered shall immediately become due and payable and we reserve the right to withhold deliveries or cancel outstanding orders. We reserve the right to charge interest on overdue accounts at 2% above our clearing bank base lending rate.
- We reserve the right at any time at our sole discretion to demand security for payment before continuing with or delivery of goods in satisfaction of any orders notwithstanding any subsisting agreement to provide credit to you.
- You shall reimburse to us the entire cost of re-presenting any cheque or other instrument delivered to us in payment of any sum due.

### 7. Delivery

- Although every effort will be made to keep delivery commitments, neither in the case of breakage in transit nor delay in delivery can we accept any responsibility or liability. Damage or shortages must be noted on the drivers delivery sheet and confirmed in writing within 3 days. We reserve the right to make an additional charge for delivery if not effected by our own transport.
- Non Arrival. Goods sent by rail or public transport will be advised at the time of despatch. Non arrival should be reported immediately in writing after a three day interval in the case of passenger trains and seven days for goods sent by rail. The report should be sent to your station or depot and to us.
- Breakages. Goods received by rail or carrier should be examined as soon as possible and a report of any damages or breakages should be sent to the station or depot and to us within three days of receipt. Unless the above condition is adhered to neither the carriers nor ourselves will accept liability.
- Our liability for delivery ends on the tailboard of our vehicle. Drivers have instructions to deliver any items they can carry to site or ground floor entrance of a building, but extra labour should be provided by customers free of charge to assist our drivers to unload heavy or bulk loads. Orders are accepted on this understanding.
- We reserve the right to make delivery by instalments and to tender separate invoices in respect of each instalment.  
In the event of any goods or any packing or container being delivered and deposited whether on the public highway or elsewhere you shall be responsible for compliance with all regulations and for all steps which need to be taken for the protection of persons or property in relation to such goods, packing or container and shall indemnify us in respect of all or any costs claims losses or expenses which we may incur as a result of such delivery.

### 8. Liability on Site

- When delivery to site necessitates a vehicle leaving a public road, the customer shall be liable for any resultant accident or damage and fully indemnify us in respect of all or any costs claims or expenses which we may incur. The price we have quoted covers delivery to the site or the ground floor entrances of the building. If the goods are required to be delivered into the building or to an upper or lower floor, express notice of that requirement must be given with the order, and arrangements made to have adequate and prompt assistance available at the time of actual delivery. If our driver has to return to the depot without completing delivery through lack of assistance, or if additional staff have to accompany the driver, an appropriate additional charge may be made. Where delivery is of palletised loads, it is the buyers responsibility to have available on the site cranes or fork lift trucks of suitable design to deal with unloading, if our driver has to return without unloading or the lorry is detained through lack of mechanical assistance, we reserve the right to make an additional charge.
- If delivery times are restricted by local traffic regulations, it is the responsibility of the buyer to advise us of the details of the restriction and to have assistance available for unloading at the agreed time. If the delivery has to be made outside our normal hours of business, we reserve the right to make an extra charge.

### 9. Liability

- No representation or warranty is given as to the suitability or fitness of the goods for any or any particular purpose and you shall satisfy yourself in this respect and shall be totally responsible therefor.
- In the event that a defect is discovered in any article sold by us and reported to us in writing during the period of 3 days from the date of delivery of the goods which defect was caused by faulty design or manufacture we will at our option either repair that article at our own expense, replace the article or refund the purchase price of the article subject in all cases to the return of the article to us at your expense.
- Save as set out above all warranties or other terms implied by statute or otherwise will not apply to this order including but not limited to those implied by the Sale of Goods Act 1979, the Supply of Goods and Services Act 1982 and the Consumer Protection Act 1987.
- We shall not be liable for any consequential or indirect loss suffered by you or any third party in relation to this order and you shall indemnify us in respect of any claim of any person in respect of any such consequential or indirect loss.
- The above clauses constitute our entire liability under this order which, in any event, shall

not exceed the contract price of this order save in respect of any liability for death of personal injury resulting from negligence.

- You shall indemnify us against any liability that we may incur as a result of a claim against us under the Consumer Protection Act 1987 in respect of the alleged defect in the goods.
- Where manufacturers of goods or materials have limited or excluded their liability in respect thereof including in respect of any consequential liability the same limitation or exclusion shall apply to our liability on the sale of those goods. Details of the Terms and Conditions upon which the manufacturers supply goods to us are available on request.

### 10. Force Majeure

We shall not be liable for any failure to deliver or delay in delivery of the goods arising from circumstances outside our control including but not limited to lock-outs, fire, accidents, defective materials, delays in receipt of raw materials or bought goods or components.

### 11. Returns

Requests for the return of goods must be made to Head Office and any credit agreed will be subject to a minimum 35% deduction for re-stocking. Drivers have orders not to accept goods without prior instructions. In no circumstances can we accept back goods which have been specially procured from works or made by us to special instructions or which have deteriorated. Nothing in this clause shall oblige us to accept the return of goods and it will be entirely within our sole and absolute discretion as to whether or not the return of goods is to be accepted and under what circumstances.

### 12. Installers

Where an installer of the goods is recommended by us such recommendation is made in good faith and without responsibility and we give no warranty as to the ability of the installer nor is any such warranty to be implied by reason of such recommendation. In no circumstances shall we be liable for any loss, damage, or expense suffered by you or any third party by reason of any acts, defaults, omissions, or delays of the installer, his servants, agents or subcontractors, whether due to his negligence or otherwise. It is declared and understood that the installer is not our agent and that he has no authority to pledge our credit or bind us in any way whatsoever.

### 13. Title and Risk

- Risk in the Goods shall pass to you when the Goods are delivered.
- The ownership of the Goods shall remain with us until you have paid all liquidated sums owed by you to us whether in respect of this order or otherwise.
- The Goods shall be stored separately from any other goods and identification marks or serial numbers on the Goods will not be interfered with.
- You are licensed to use or agree to sell the Goods subject to the express conditions that:
  - the entire proceeds of any sale or insurance proceeds received in respect of the Goods are held in trust for us and not mixed with other monies or paid into an overdrawn bank account and shall at all times be identifiable as our money.
  - notification of our claim to title of the goods is given to purchasers of the goods.
  - we are notified of any term in any contract for sale of the goods contrary to our interest in the title to the goods.
- We may at any time recover and re-sell goods in which title shall not have passed to you. We by our servants and agents shall be entitled to access to your premises or those to which you have a right of access where the goods or some of them are stored or thought to be stored for the purpose of re-possession at any time.
- You shall indemnify us against any costs, expenses or losses incurred or sustained by us in exercise of our rights under this clause.

### 14. Insolvency and Breach of Contract

We shall have the option (without prejudice to any other rights against you) to rescind the contract or to suspend deliveries and all sums payable to us shall become due and payable forthwith and we shall be entitled to exercise our right to recover goods under Clause 13E above on the following events:-

- Should any sum owing by you to us be overdue.
- Should you be in breach of any term of the contract.
- If you being a company compound or enter into any composition or arrangement with your creditors or a proposal is made for a Voluntary Arrangement with your creditors; have a Petition presented for the appointment of an Administrator or for your winding up or an Administrator is appointed or a Winding Up Order made; have a Receiver or Manager or Administrative Receiver appointed over all or any part of your assets; are unable to pay your debts within the meaning of Section 123 of the Insolvency Act 1986; pass a resolution for your voluntary winding-up save for the purpose of amalgamation or reconstruction or enters Voluntary Liquidation; are removed for any reason from the Register of Companies.
- If you are an individual and enter a Deed of Arrangement or make any assignment for the benefit of or enter into any arrangement voluntary or otherwise with your creditors either by composition or otherwise; make or have an application made for an Interim Order in connection with a proposal to creditors for a Voluntary Arrangement; have a Petition presented for your Bankruptcy or are made Bankrupt.
- If we have bona fide doubts as to your solvency.

### 15. Jurisdiction

Every contract to which these conditions apply shall be construed and operate as an English contract and in accordance with English law. Disputes shall be submitted to the jurisdiction of the English courts.

In addition to the conditions above the following conditions apply to all contracts for Glass and Glazing:-

- Quotations are based on the cost of materials and labour and transport at the time of the quotation. We shall be entitled to adjust the prices to be charged by such amounts as may be necessary to cover any direct or indirect price increases sustained by us after the date of the quotation.
- All necessary equipment for the glazing to be supplied by you. You shall indemnify us and our employees in respect of all or any costs, claims, losses or expenses which may be suffered as a result of the use of such equipment.
- Temporary shopfronts and repairs should be removed by you to prepare shopfronts ready for glazing.
- Any variation of work or materials to be charged extra and allowed for.
- Reglazing to roofs will be carried out in a workmanlike manner, but where existing bars have been straightened and reglazed, a watertight job cannot be guaranteed.
- An estimate is based on the understanding that provision on site will be made free of charge to us of all equipment and facilities to enable us to fulfill statutory requirements.
- The glazing of squares less than 0.10 metres super will be charged for a 0.10 metres super.
- If glass is placed in position full glazing or replacement charges will be made.
- Unless specifically stated, prices do not provide for making templates for shaped or bent plates or glazing for boats, swings or ladders, and for other special work.
- Unless otherwise stated, prices quoted are for glazing in wood sashes in linseed oil putty. Any other type of glazing will be charged according to the work required.
- Glazing does not include the cleaning of the glass.
- Our liability for damage to the glass shall cease as soon as the glass is glazed and you shall indemnify us in respect of all or any costs, claims, losses or expenses which may be suffered by us as a result of damage to the glass thereafter.