

Fixfast Fastener Selector Guide

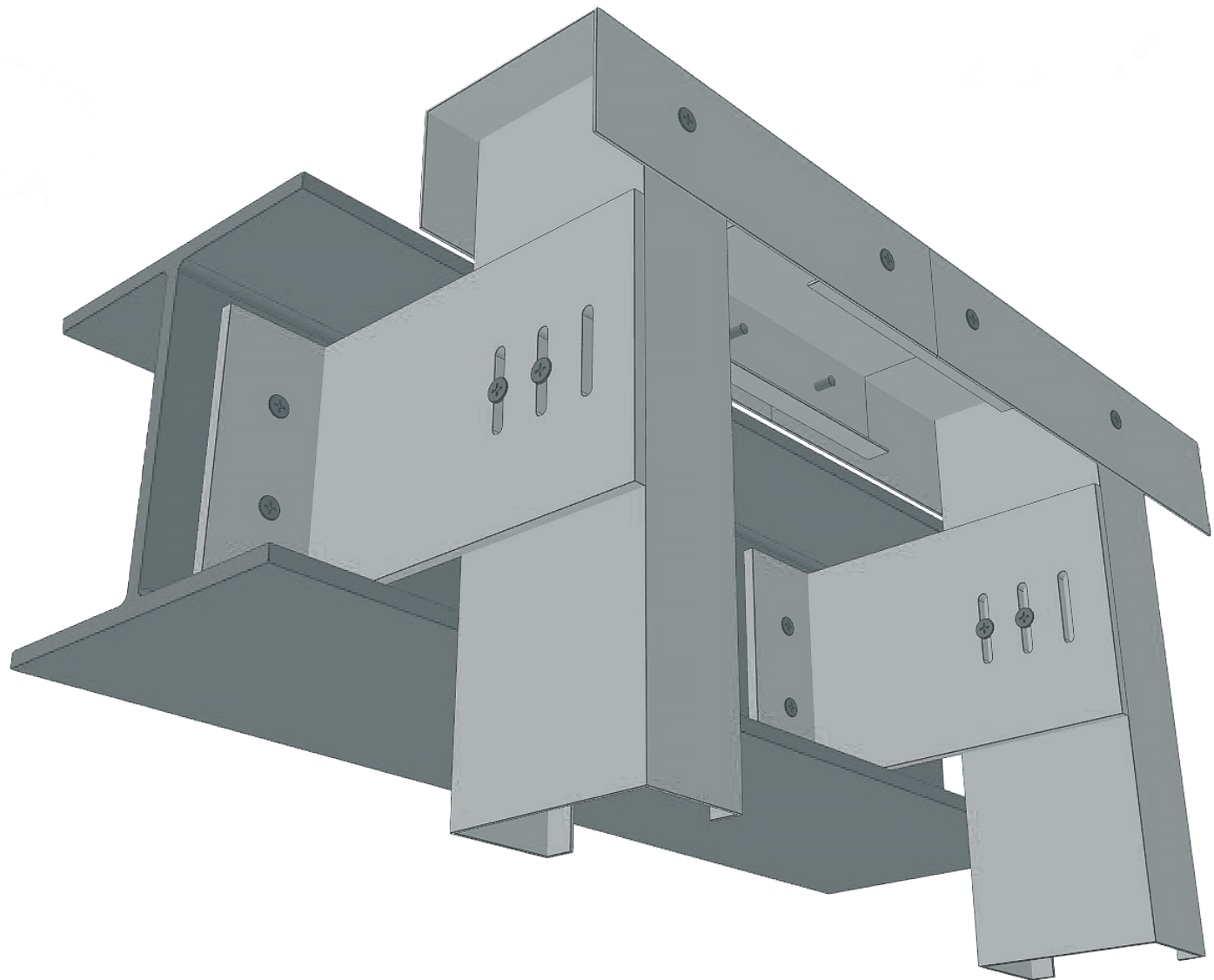

Light Gauge Steel Framing

For use with



by voestalpine

Light gauge steel framing fastener selector guide

TABLE 1 - GENERAL FRAMING FIXINGS







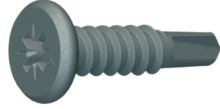

Code	Application	Description	Picture	Fixfast Code
G1	General framing screw fixing studs/joists/runners and bracing sections 1.2-1.5mm to 1.2-1.5mm steel	5.5mm diameter pan head screw		DF3-CF-5.5 x 22
	General framing screw fixing studs/joists/runners and bracing sections 1.2-3.0mm to 1.2-3.0mm max steel	5.5mm diameter hex head screw		DF3-5.5 x 25
G2	General framing screw fixing studs/joists/runners and bracing sections. 1.2-3.0mm max to 3.0-12.5mm max steel	5.5mm diameter low profile head screw		DF12-CF-5.5 x 38
		5.5mm diameter hex head screw		DF12-5.5 x 38

TABLE 2 - FIXINGS TO CONCRETE BLOCK

Code	Application	Description	Picture	Fixfast Code
C1	Fixing 1.2-3.0mm steel to concrete	Concrete screw anchor - hex head		HTF-6.3 x 32
C2	Fixing 3.0-15.0mm steel to concrete	Concrete screw anchor - hex head		HTF-6.3 x 45
C3	Fixing 1.2-15.0mm steel to concrete	Large diameter concrete screw anchor - hex head		FBS-8 x 55 - FBS-14 x 150
		Chemical / Adhesive anchors		RM resin capsule and RGM-8/110 - RGM-30/380
		Stud Anchors		FAZ-II-8/10 - 24/60

Light gauge steel framing fastener selector guide

TABLE 3 - FIXING INSULATION TO STEEL



Application	Description	Picture	Fixfast Code
Fixing 50mm insulation to 1.2mm steel	Large washer with stainless oval head screw		SF-70-D SF-RS-SSA4-4.8 x 80
Fixing 50mm insulation to 1.2-3.0mm steel	Large washer with stainless hex head screw		SF-70-D DF3-SS-HT-5.5 x 85
Fixing 50mm insulation to 3.0-6.0mm steel	Large washer with stainless hex head screw		SF-70-D DF12-SS-HT-5.5 x 95

TABLE 4 - FIXING BRICK TIE CHANNELS TO STEEL







Application	Description	Picture	Fixfast Code
Fixing BTC via 50mm insulation to 1.2-3.0mm steel	5.5mm diameter stainless hex head screw with EPDM sealing washer		DF3-SS- HT-A15-5.5 x 85
Fixing BTC via 50mm insulation to 3.0-6.0mm steel	5.5mm diameter stainless hex head screw with EPDM sealing washer		DF12-SS- HT-A15-5.5 x 95

TABLE 5 - FIXING SHEATHING BOARDS AND TIMBER TO STEEL

Application	Description	Picture	Fixfast Code
Fixing to 1.5-3.0mm steel. Board thickness 6-19mm	4.8mm diameter wafer/CSK ribbed head wing tipped screw		DF3-W-4.8 x 38
Fixing to 1.5-3.0mm steel. Board thickness 13-29mm	5.5mm diameter wafer/CSK ribbed head wing tipped screw		DF3-W-5.5 x 50
Fixing to 1.5-3.0mm steel. Board thickness 25-60mm	5.5mm diameter wafer/CSK ribbed head wing tipped screw		DF3-W-5.5 x 80
Fixing to 1.5-3.0mm steel. Board thickness 85-100mm	5.5mm diameter wafer/CSK ribbed head wing tipped screw		DF3-W-5.5 x 120
Fixing to 3.0-6.0mm steel. Board thickness 10-24mm	5.5mm diameter wafer/CSK ribbed head wing tipped screw		DF12-W-5.5 x 60

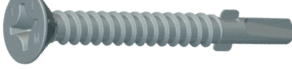

Merlin House
Seven Mile Lane
Borough Green
Sevenoaks
Kent
TN15 8QY

Enquiries
0800 304 7616

International
+44 (0) 1732 882387

Fax
0845 450 7486

Email
info@fixfast.com



Certificate number 10905
ISO 9001, ISO 14001
OHSAS 18001