

Innovation | Manufacturer | Design | Solution

**MS 500 FIRE**



# Delta's Fire Retardant Waterproofing Membrane



# CONTENTS

---

OVERVIEW	03
A DELTA SOLUTION	04
SERVICES	05
MS FIRE RETARDANT	06
FIRE RETARDANT	07
FIRE RATINGS	08
TYPES AND GRADES OF WATERPROOFING	09
BRITISH STANDARDS	010
BS8102:2009 DESIGN PHILOSOPHY	011
MEANS OF ESCAPE	013
DEFINITIONS	014
MS 500 FIRE	016
FIRE RETARDANT TAPE	017
PT ULTRA FIX PLUGS	018
SYSTEM COMPONENTS	020
TECHNICAL DRAWINGS	023
GUARANTEES	027

# OVERVIEW

---

## MS 500 Fire Retardant

Innovation is a pulse at Delta, we thrive on making the impossible, possible.

As with all Delta products, no one knows protection like we know protection. We've learnt how to protect buildings from the most extreme conditions imaginable all over the world. Quality is consistent because of our unparalleled manufacturing and quality control processes.

Delta's new innovative fire retardant MS 500 membrane gives a unique opportunity to the structural waterproofing sector for Type C systems to be used in reducing the spread of fire or where installation has not previously been possible for fire safety reasons.

Delta MS 500 Fire offers a B-S2, d0 Euroclass fire rating (EN 13501-1:2018) whilst maintaining its strength, durability, functionality and workability.

Delta's new fire retardant Type C Cavity Drainage System provides architectural freedom and allows systems to be used in not only deep basements but where national Building Regulations Euroclass B or C are required, meeting building requirements of today, but also that of tomorrow.

## Surface Quality and Appearance

Delta MS 500 Fire offers a B-S2, d0 Euroclass fire rating (EN 13501-1:2018) whilst maintaining its strength, durability, functionality and workability.

The first and most important element of a Type C membrane is keeping structures dry. Water ingress will potentially result in a corrosive environment, with structures having a reduced life service. Delta MS 500 Fire Retardant has been manufactured using DELTASAFE, compared to the traditional MS 500 membranes. In terms of appearance, Delta MS 500 Fire Retardant has the same physical properties to MS 500, a membrane designed from High-Density Polyethylene with 8mm stud. What happens during a fire Delta MS 500 fire retardant enhances a structure's fire performance. MS 500 fire retardant not only slows down but will reduce the intensity of a fire, limiting damage to a build's structure and its contents

# Delta's New Fire Retardant Waterproofing Membrane



# A DELTA SOLUTION

BS 8102:2009 (Code of Practice for Protection of Below Ground Structures Against Water from the Ground) recommends that every Design Team should incorporate a Waterproofing Design Specialist.

Delta Membrane Systems Limited has a dedicated team of Waterproofing Design Specialists. Our trusted Technical Team offer knowledge and experience and are able to provide expertise in structural waterproofing. As a Waterproofing Specialist Manufacturer, we work with architects, surveyors, contractors and engineers alike to provide a design service which complies with BS 8102:2009 and offers the highest level of technical expertise and assurance.



## BELOW GROUND WATERPROOFING SOLUTIONS FOR:

- Residential Buildings
- Commercial Buildings
- Retail Units and Warehouses
- Leisure Facilities
- Archives/Libraries/Vaults
- Hospitals
- Schools
- Underground Rail Stations and Tunnelling
- Underground Car Parking areas
- Listed Buildings
- Heritage Buildings
- Insulated Formwork Construction (ICF)



# SERVICES

Delta Membrane Systems Limited provides a full range of waterproofing solutions suitable for all new, retrofit and refurbishment construction. With over 125 years of manufacturing experience Delta is an impeccable partner on every project. Our skills have been mastered through experience in the waterproofing industry. Delta's trusted Technical Team will offer assistance from concept to completion. Our hands on approach and knowledge is what sets us apart.



## DESIGN SUPPORT

- Architecture knowledge
- Concept and waterproofing solutions
- Advice on design and best practice
- Custom solutions, as each project is unique requirements
- Qualified CSSW staff (named on the Waterproofing Design Register)

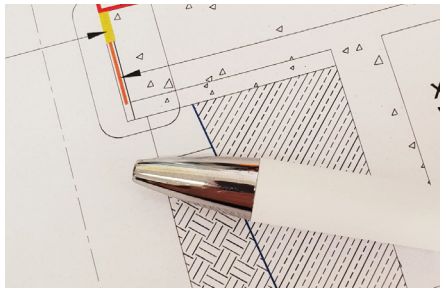

## SPECIFICATION SUPPORT

- Detailed drawings including CAD
- Watertight and locking down structure concepts
- Specifications
- BIM
- NBS Plus
- RIBA Product Selector

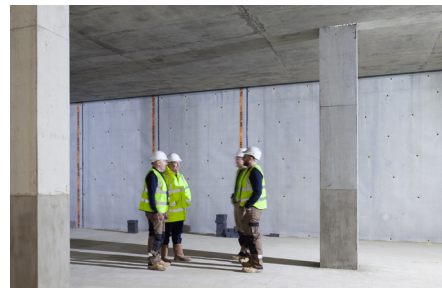

## SITE SUPPORT

- Training and guidance offered at every step
- Technical Team attendance at site meetings
- Knowledge and experience
- Troubleshooting solutions



# MS FIRE RETARDANT



# FIRE RETARDANT

---

## What is a Fire Retardant?

A fire retardant is a substance that is used to slow down or stop the spread of fire or reduce its intensity. This is commonly accomplished by chemical reactions that reduce the flammability of fuels or delay their combustion.

The Delta Fire Retardant range has been manufactured with DELTASAFE, a new innovative fire-retardant property which enables our MS 500 membrane to achieve a Euroclass rating of B-S2, d0 in accordance with EN 13501-1:2018.

Fire retardant Type C Cavity Drainage Membranes can considerably improve the reaction to fire of normal Type C Cavity Drainage Membranes.

## What is the Difference Between Fire Retardant and Flame Retardant?

Fire retardant and flame retardant both work to prevent fires, in occurrence of fires to stop the spread and help to reduce the amount of damage caused by flames. Both are invaluable to protecting homes and structures and provide extra time to for residents to safely evacuate a building if a fire does occur.

## Specialist manufacturer of Class B-S2, d0 Fire Retardant Type C Waterproofing Systems

Designing a waterproofing scheme is no simple matter. Our technical teams operate on a nationwide basis, helping to identify project requirements and ensuring the right technical expertise is applied with a broad spectrum of communication and thinking styles to ensure your projects comply with the latest Building Regulations.

Our relationships are based on trust, and each and every one of our customers use Delta by choice.

Please call us on 01992 523 523 and we will be happy to assist you or email to [info@deltamembranes.com](mailto:info@deltamembranes.com). To learn more about our extensive range of structural waterproofing solutions please visit our website [www.deltamembranes.com](http://www.deltamembranes.com).



# FIRE RATINGS

## Euroclass Fire Ratings

Reaction to fire, often called the Euroclass system gives building products a classification. The 'Reaction to fire' classes test three properties of the building material: spread of fire, smoke intensity and burning droplets. Most building materials sold on the European market must be assigned a file indicating its fire resistance based on a Euroclass rating system. There are 7 Euroclasses of reaction to fire performance for construction products which extend from A1 to F.

### Euroclasses and the target safety level

Euro-class	Target safety level
A1	No contribution to fire even under fully developed fire conditions
A2	Only negligible contribution to fire even under fully developed fire conditions; no spread of fire from the area of the primary fire in the fire development phase
B	In the fire development phase, no spread of fire from the area of the primary and very limited contribution to the fire
C	Under the conditions of a fire in the development phases, very limited spread of fire and limited energy release and ignitability
D	Under the conditions of a fire in the development phases, limited spread of fire and acceptable energy release and ignitability
E	In the case of a very small fire (match flame) acceptable reaction to fire (ignitability, flame spread)
F	No requirements concerning the reaction to fire

### Additional assessment classes for smoke development and burning droplets/particles

Smoke development	s3 (there are no restrictions regarding smoke development) s2 (the fully released amount of smoke, and the rise in smoke development are restricted) s1 (stricter criteria than for s2 must be fulfilled)
Burning droplets/particles	d2 (there are no restrictions) d1 (burning droplets not longer than the defined time) d0 (dripping fire debris is not permitted)





# GRADES AND TYPES OF WATERPROOFING

There are many different approaches to structural waterproofing. The construction methods will in part contribute to the specification of types of waterproofing systems and may also determine the overall structural waterproofing strategy.

## Structural waterproofing falls into 3 categories:

Type A – Barrier Protection

Type B - Structurally Integral Protection

Type C – Drained Protection

## With 3 grades:

Grade 1 – Some water seepage and damp are tolerable depending on the intended use

Grade 2 – No water penetration is acceptable

Grade 3 – No dampness or water penetration is acceptable and dehumidification

Residential/Commercial Basements



Car Parks



Museums and Heritage



Hospitals



Schools



Hotels



Infrastructure Projects



Railway and Tunnelling



Libraries

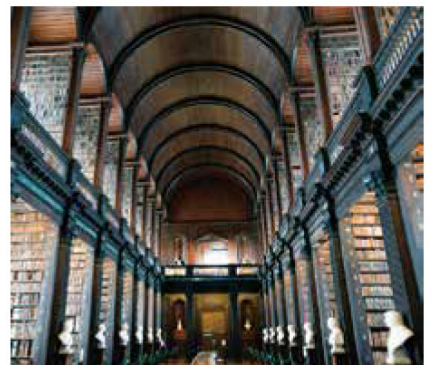

# BRITISH STANDARDS

## BRITISH STANDARDS

Established in 1901 the BSI Group (formerly the Engineering Standards Committee), sought to standardise the types of steel manufactured in Great Britain in order to assist with competitiveness and efficiency.

Over decades these standards have been developed to cover numerous aspects of the engineering/building sector including engineering methodologies, quality, safety, systems and security.

### BS 8102:2009

British Standard 8102 'Code of practice for protection of below ground structures against water from the ground' was first publicised in 1990 with the second edition being publicised in November 2009. BS 8102:2009 supersedes BS 8102:1990 and CP102.

BS 8102 is a standard designed to protect the consumer. BS 8102 has been formulated to ensure the correct waterproofing solution has been selected and adhered to during the build process.

### BS 8102 covers (but is not limited to):

- Cavity drain
- Cut-off wall
- Damp area
- Embedded retainer wall
- Ground barrier
- Loading coat
- Perched water table
- Seepage
- Tanking
- Barrier protection
- Vapour
- Waterproofing
- Waterproofing barrier
- Waterproofing system
- Water resistance
- Waterstop
- Water vapour
- Water vapour resistance



### NHBC CHAPTER 5.4 OFFERS A CHOICE OF STRATEGIES:

- Design Standards
- Statutory Requirements
- Load-bearing Structure
- Principles of Design
- Structural Deck
- Thermal Insulation and Vapour Control Layers
- Waterproofing and surface finishes
- Rainwater Drainage
- Guarding to Balconies
- Access for Maintenance
- Provision of Information

# BS8102:2009 DESIGN PHILOSOPHY

---

## Fire Resistant Design Considerations in Basements/Below Ground Structures

Important considerations should be given when designing a basement or below ground structure on how it will behave during the event of fire. Whilst a basement is not counted when assessing the numbers of storeys of a property for fire resistance and means of escape, it should be factored into design and be a key consideration. Typically, 30 minutes fire resistance is required for a two-storey house over a basement, which increases to 60 minutes where the number of storeys is four or more.

Designers should consult the relevant approved documents to check requirements related to their specific design and for other housing types.

Fire separation between a basement and upper storeys is required if the height of the top floor is more than 4.5 metres above the lowest external ground level. This situation is only likely to occur in two-storey dwellings if the basement floor level is less than 1.2m below the external ground level or located on a very sloping site.

The walls and floor between garages and houses also require 30 minutes fire separation which also applies if located in a basement.

Ground floor flats or maisonettes with a basement level and direct main entrances require no fire separation over and above typical fire separation between apartments.



# BS8102:2009 DESIGN PHILOSOPHY

There are many different design challenges experienced when designing a suitable, maintainable and capable waterproofing system. From existing basements to multi-level basements, basements which will encompass high water tables to basements constructed against adjacent properties, no one size fits all, there are many different challenges which make every basement and below ground structure unique.

To design a robust waterproofing solution for protecting a structure, BS8102:2009 Code of Practice for the protection of below ground structures against water from the ground, brings guidance on the methods which should be adopted to deal with and prevent the entry of water and water vapour from the ground into a structure.

A Type C Cavity Drainage System is a maintainable basement waterproofing solution suitable for new-build basements, refurbishment and retrofit projects. The Type C System comprises of a Cavity Drain Membrane, Drainage system, Submersible Package Pump and Control System. This type of system is designed to combat water ingress and can be used to habitable grades 1-3 in according to BS 8102:2009.

The Delta Fire Retardant Type C Cavity Drainage System is the safest form of waterproofing system available, offering complete protection from water or water vapour and fire retardant protection.

Our Design and Build Philosophy is quality driven, working with architects and trades alike, putting at the forefront construction considerations to ensure buildability, functionality, and maintainability. The result of this single approach is a consistent, complete, and quality design that is hard to equal.

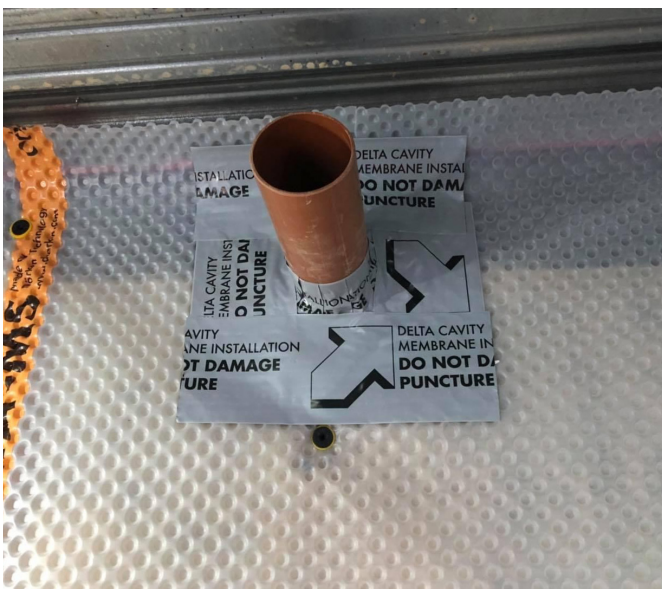

# MEANS OF ESCAPE

---

Building regulations ensure that new buildings, renovations, extensions and conversions both in domestic and/or commercial structures are going to be safe, healthy and high-performing. Regulations also cover specific topics within the built sector: structural integrity, fire protection, accessibility, gas safety, electrical, energy performance, acoustic performance and protection against falls.

Standards which are particularly aimed at basements and below ground structures are: protection against the ingress of water, protection against contamination (including methane, carbon dioxide, volatile organic compounds (VOCs) and radon gas), ventilation, drains, along with others.

Building regulation approval is required for the construction, adaptation and extension of all basements and below ground structures.

## **Fire Safety –The Importance of Fire-Resistant Construction Materials**

It is essential for building products to meet a variety of performance requirements. Depending on the type of material and its intended application, specific fire performance properties are tested.

The Building Research Establishment (BRE) offer a wide range of fire resistance testing (from British to European fire test standards) for construction industries for the purpose of complying to UK Building Regulations or for European Classification and CE Marking.

## **Means of escape**

Habitable rooms in basements require a safe means of escape. The maximum distance that people must travel, from any point in a building to a place of safety, is usually termed the "travel distance". A safe means of escape from a basement could be provided by the main staircase of a structure, provided it is protected and connected to a final exit. Alternatively, escape can be provided by an additional stair offering an alternative final exit. Escape through windows is permissible if designed to permit escape as defined by the building regulations.

It is worth noting that non-habitable rooms in basements, such as kitchens, utility rooms and bathrooms can be classed as inner-rooms and depending upon the layout of the structure may not require separate means of escape.

It is permissible to exit into gardens or courtyards, provided they have an exit to a place of safety or are greater in area than the height of the structure.

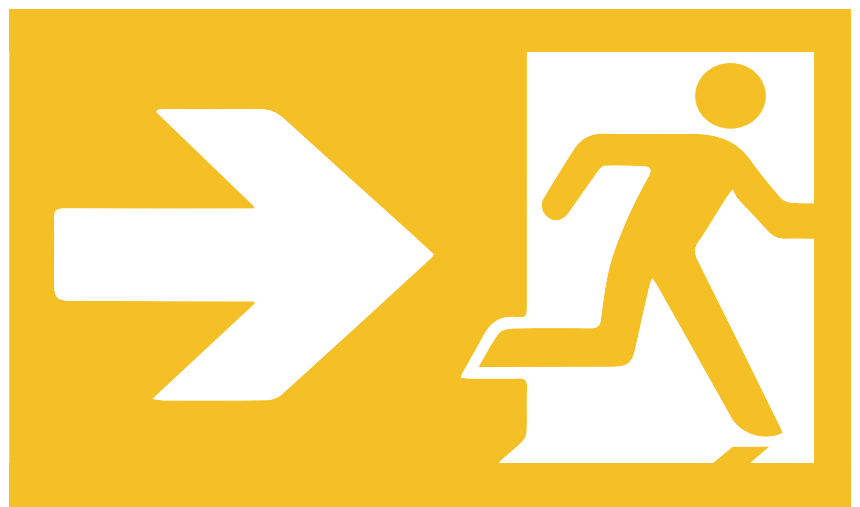

# DEFINITIONS

---

## **Ancillary Product**

Allowing for application of the Type C Cavity Drainage System on different substrates and surfaces both sealing the membranes and detailing with any provisions whilst preventing condensation.

## **Aquaduct**

Delta Aquaduct is a drainage pipe which acts as a perimeter conduit which is bedded into a preformed opening at the floor/wall junction.

## **Basement Drainage**

'Basement drainage' is a broad term that refers to the removal of water either as a part of or to assist with the waterproofing of the basement.

## **Battery Backup**

A backup battery provides power to a basement drainage system when the primary source of power is unavailable.

## **Cavity Drain System**

In principle a cavity drain membrane system allows moisture or running water to travel behind the membrane within a controlled drainage system. A cavity drain system requires minimal preparation and disturbance to an existing substrate.

## **Fire Protection**

The duty of the fire protection system may be to extinguish the fire, control the fire, or provide exposure protection to prevent domino effects.

## **Fire Retardant**

A fire retardant is a substance that is used to slow down or stop the spread of fire or reduce its intensity. This is commonly accomplished by chemical reactions that reduce the flammability of fuels or delay their combustion.

## **Foul Water**

Wastewater from the kitchens and bathrooms of buildings, which discharges into the drainage system to be carried to treatment plants.

## **Free Lime**

When new concrete is introduced to structures, there is a risk of excess free lime leaching out during the curing process in the form of calcium hydroxide, this free lime, if untreated, can enter the Cavity Drainage System which can impede the flow of water and cause sump pump failure.

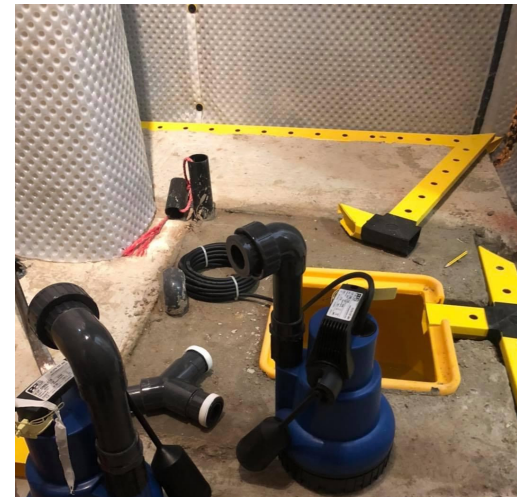

# DEFINITIONS

---

## **Groundwater**

Groundwater is the water found underground in cracks and spaces in soil, sand and rock. It is stored in and moves slowly through geologic formations of soil, sand and rocks.

## **High Water Level Alarm**

Designed to detect high water levels within sump pump chambers.

## **Modular Drainage**

As an alternative to the Delta Perimeter Drainage Channel, a Modular Drainage System may be considered using 110mm standard underground drainage pipe. As with all drainage systems it must be maintainable. We recommend contacting a member of Delta's Technical Team when utilising this method.

## **Negative Side Waterproofing**

An internal waterproofing system.

## **Perimeter Drainage**

Perimeter Drainage Channel is used as part of a Type C Waterproofing Solution. The perimeter drainage channel is a piping system engineered specifically to collect water at the bottom of a cavity drainage membrane.

## **Positive Side Waterproofing**

An external waterproofing system.

## **Service Penetrations**

Service penetrations are created using a cast-in-place sleeve, in a wall or floor assembly, for the purpose of accommodating the passage of a mechanical, electrical or structural service.

## **Surface Water**

Any body of water above ground, including streams, rivers, lakes, wetlands, reservoirs, and creeks.

## **Sump Pump**

A sump pump is a pump used to remove water from basements of homes.

## **Type C Cavity Drainage Membrane**

A Type C (drainage) system is a water management system in which a cavity drain membrane is used to control water ingress in a structure or building. This type of system is designed to combat water ingress and can be used to grades 1-3, according to BS 8102:2009.

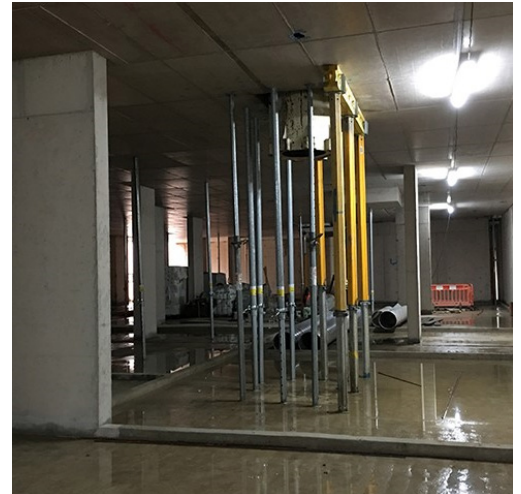

# MS 500 FIRE

Delta MS 500 Fire Retardant is a new 8mm studded Type C, Cavity Drainage Membrane that has been manufactured with DELTASAFE, a new innovative fire-retardant property which enables Delta MS 500 Fire Retardant to achieve a Euroclass rating of **B-S2, d0** in accordance with EN 13501-1:2018.

This Fire-retardant High-Density Polyethylene (HDPE) cavity drainage membrane has an 8mm studded clear profile. Suitable for use on the internal faces of walls and floors as a water management system for the protection of below ground structures against the potentially adverse effects of ground water ingress.

Table 1: 30s Surface Exposure

Temperature: 22.6°C      Relative Humidity: 51.2%      Air Velocity: 0.67 m/s  
 Exposure Condition: Surface    Flame Application Time: 30 s    Operator: C. A. Rock  
 Number of Test Runs: 6      Deviations from Test Standard: None

Run No.	Occurrence of Ignition Y/N	Time of Ignition (s)	Duration of Flaming (s)*	Flame Spread to 150 mm (Y/N)	Time to Reach 150 mm	Maximum Flame Spread	Ignition of Filter Paper
1	Yes	11	19	No	N/A	45	No
2	Yes	12	15	No	N/A	52	No
3	Yes	9	15	No	N/A	65	No
4	Yes	12	16	No	N/A	47	No
5	Yes	11	16	No	N/A	65	No
6	Yes	11	15	No	N/A	64	No

N/A Not Applicable      \*Measured to end of 60 s test duration

Table 2: 30s Edge Exposure

Temperature: 18.0 °C      Relative Humidity: 51.5%      Air Velocity: 0.69 m/s  
 Exposure Condition: Edge    Flame Application Time: 30 s    Operator: C. A. Rock  
 Number of Test Runs: 7      Deviations from Test Standard: None

Run No.	Occurrence of Ignition Y/N	Time of Ignition (s)	Duration of Flaming (s)*	Flame Spread to 150 mm (Y/N)	Time to Reach 150mm	Maximum Flame Spread	Ignition of Filter Paper
1F	Yes	1	10	No	N/A	25	No
2P	Yes	1	11	No	N/A	70	No
3P	Yes	1, 25	13, 5	No	N/A	65	No
4P	Yes	1	20	No	N/A	70	No
5P	Yes	2	17	No	N/A	70	No
6P	Yes	2	10	No	N/A	70	No
7P	Yes	1	10	No	N/A	70	No

N/A Not Applicable      \*Measured to end of 60 s test duration F Planar flat edge      P Profiled Edge

## SPECIFICATIONS

- Type C Drained Protection in accordance with BS 8102:2009
- NBS J40 (clause 290) flexible sheet tanking/damp proofing
- EN-13501-1:2018 Classification of reaction of fire performance





# MS 500 FIRE

## TECHNICAL DATA

Material	High Density Polyethylene (HDPE)
Sheet Thickness	0.5mm
Stud Height	8mm
Roll Size	2.4m x 20m
Compressive Strength	>250 kN/M <sup>2</sup>
Drainage Capacity	2.25 L/S M 135 L/MIN M 8 100 L/H M
Air Volume Between Studs	5.3 L/M <sup>2</sup>
Temperature Resistance	-30°C to +80°C
Reaction to Fire	EN 13501-1:2018 Class B-S2, do
R Value	0.12 M <sup>2</sup> K/W

Test method & test number	Parameter	No. test runs	Results	
EN 13823 Q101176-1001 Tested: 07/10/2020 24/11/2020 E12946 & E13187	FIGRA 0.2MJ FIGRA 0.4MJ LFS THR 600s	3	Continuous papameter mean (m)  110.6g W/s 110.6g W/s (-) 4.16 MJ	Compliance with parameters criterion/ compliance status B-s2, do  < 120 W/s Compliant -/- < edge of specimen compliant < 7.5 MJ/Compliant
	SMOGRA TSP 600s		35.12 m2/s2 83.73 m2	< 180 m2/s2/Compliant < 200m2/Compliant
	Flaming droplets/particles < 10s Flaming droplets/particles > 10s		Not Observed Not Observed	Flaming < 10s/Compliant Flaming > 10s/Compliant
EN ISO 11925-2 30s Surface Q101176-1000 Tested: 14/09/2020 E12945	Fs Flaming droplets/particles	6	Not Observed Not Observed	< 150mm within 60s/Compliant No ignition of paper/Compliant
EN ISO 11925-2 30s Edge Q101176-1000 Tested: 30/11/2020 E13187	Fs Flaming droplets/particles	7	Not Observed Not Observed	< 150mm within 60s/Compliant No ignition of paper/Compliant

# FIRE RETARDANT FLEECE TAPE

Delta Fire Retardant Fleece Tape is a high-performance fleece-backed butyl waterproof sealing tape for butt joints and overlapping of membranes. This flexible, self-adhesive tape enables the sealing of membranes together, join or where overlapping is required.

**Surface preparation:** All surfaces should be clean, dry and free from frost, grease and loose materials.

**Application:** Remove the release paper and apply the tape to the substrates to be joined. Take care to avoid rucks in the tape. Roll the tape with a small roller to ensure good adhesion along the whole length of the tape.

## TECHNICAL DATA

Colour of strip	Black
Roll	100mm x 20m
Application Temperature	+5 °C/+40 °C
Shelf Life	24 months when stored flat in original packaging in cool, dry conditions
Storage Temperature	15 to 25 °C

- Suitable for use with Delta MS 500 Fire Retardant Membrane
- Excellent adhesion to a wide range of substrates
- **B-S2, d0** fire rating in accordance with EN 13501-1:2018
- Good sealing properties
- Remains flexible throughout its service life
- Designed for use on walls and floors
- Easy to apply
- Can be used for overlapping of membranes
- Can be used for butt joints
- Can be plastered or rendered over straight away
- Independent Third Party Testing

## SPECIFICATIONS

- Type C Drained Protection in accordance with BS 8102:2009

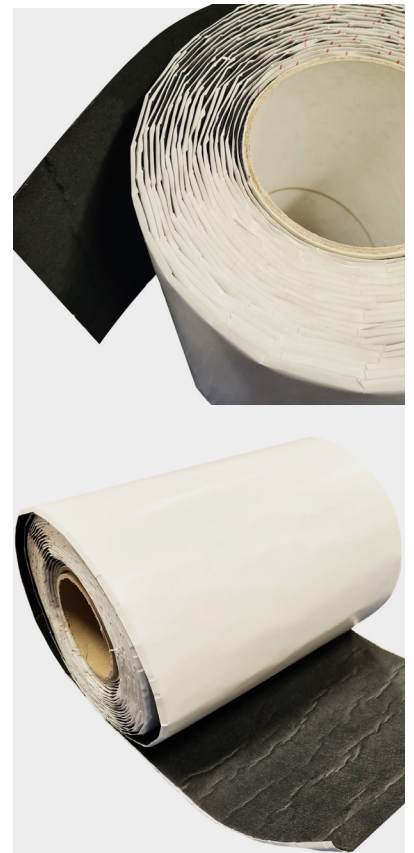

# DELTA ULTRA FIX PLUGS

Delta Ultra Fix plugs are specifically designed to fix and secure our Delta MS 500 Fire Retardant Membrane. Delta Ultra Fix plugs offer a tailor-made maximum hold for ease of installation.

Delta's new innovative fire-retardant MS 500 membrane gives a unique opportunity to the structural waterproofing sector for Type C systems to be used in reducing the spread of fire or where installation has not previously been possible for fire safety reasons.

## SPECIFICATIONS

- Type C Drained Protection in accordance with BS 8102:2009

## TECHNICAL DATA

Size	9mm shank/52mm
Contents	Box of 200
DMS Code	DMS051
Drill hole size for fixing in wall	60mm x 90mm

- Fire Retardant fixing plug
- Suitable for use with Delta MS 500 Fire Retardant Membrane
- **B-S2, d0** fire rating in accordance with EN 13501-1:2018
- Developed to provide a good key for plasters and renders
- Has a centrally located internal shank which can accommodate a 5.5mm diameter/size 12 screw for installation of pipe clips, cable tracks and lining systems
- Provides a watertight seal



ULTRA FIX PLUG

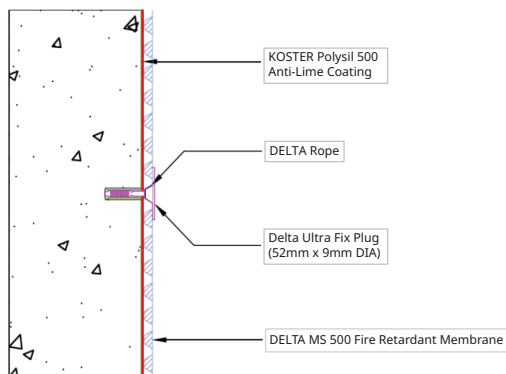

ULTRA FIX PLUG FIXING DETAILS

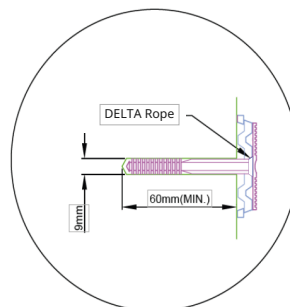

# SYSTEM COMPONENTS

---



## KOSTER POLYSIL TG500

Product Code: DMS170

Polysil TG 500 anti-lime – is a deeply penetrating primer for damp, salt-containing substrates and an anti-lime treatment for new concrete which also acts as a liquid hardener for sealing slurries.

Koster Polysil TG 500 is an 'anti lime' coating product specially blended with Polymers and silicates which is applied by brush or spray application. Applying Polysil-TG 500 will not only reduce the amount of free lime leaching into the Cavity Drainage System but will also improve the water resistance of the basement structure by absorption into the structure and locking in the free lime.

## KOSTER NB 1 GREY

Product Code: DMS178

Koster NB 1 Grey is a mineral coating containing crystallising and capillary-plugging agents. This waterproofing slurry system can be used for sealing against pressurized water (> 13 bar). Koster NB 1 has a Euroclass rating of A1 and can be used for waterproofing against ground moisture, and for non-pressurized and pressurized water.

NB 1 Grey is characterized by excellent resistance to pressure and abrasion as well as chemical and sulphate resistance. Due to its penetration into the structure, the slurry develops an intense bond to the substrate and capillaries are plugged. Besides the hydraulic curing of the sealing slurry, crystallizing reactions are activated in the slurry which can lead to a self-healing effect.



## KOSTER KB FLEX 200

Product Code: DMS237

Permanently plastic, damp and waterproof sealing compound for waterproofing against pressurized water

Koster KB-Flex 200 is a permanent plastic sealing compound ideal for sealing pipe and cable penetrations, cavities and for custom detail waterproofing solutions against moisture and pressurized water.



# SYSTEM COMPONENTS



## DELTA CORNER STRIP

Product Code: DMS020

Delta Corner Strip is a waterproof, firm and lasting single-sided sealing tape, applied to seal wall to floor junctions. Delta Corner Strip creates a vapour seal, an ideal solution for patch repairs and detailing around service penetrations (150mm x 20 m).

## DELTA CHANNEL

DMS 207 (With Upstand), DMS 208 (Without Upstand)

Delta Channel is a component part used within a Type C Cavity Drainage System. Delta Channel is a distinctive yellow, PVC drainage conduit designed to manage water ingress and hydrostatic water pressure in basements and below ground structures.

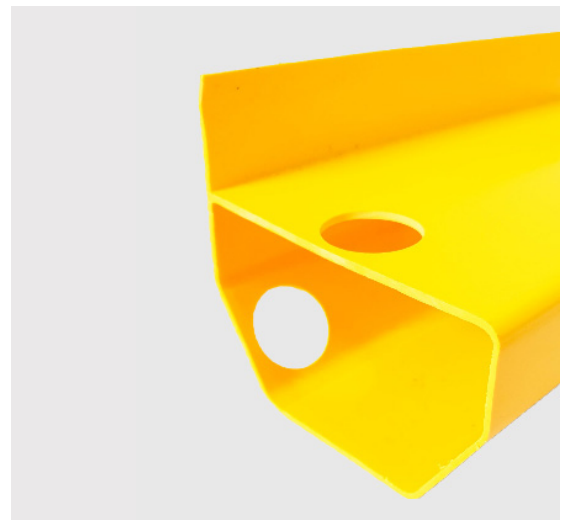

## MS20 ACCESS PORT

Product Code: DMS124

Access ports allow for inspection of the drainage system and a suitable access for flushing (using a suitable lime solution). The MS20 Access ports are supplied pre fixed into a rectangular piece of Delta MS20 which can be linked and sealed in the standard manner for our MS20 membranes.

# SYSTEM COMPONENTS



## PACKAGED PUMP SYSTEMS

Product Code: DMS164

The concept of a Drained Cavity System is to collect and manage any group water which breaches the integrity of a structure by managing, collecting and discharging such free water via a suitable evacuation point such as a Delta Package Pump Station.

Delta offer a comprehensive range of Package Pump Stations which are suitable for the evacuation of Ground water, Surface water, Foul water and Flood water. In addition we offer bespoke chambers for larger properties. Delta's sump pumps offer complete peace of mind.

## ALARMS & CONTROL PANEL

Product Code: DMS298 and DMS299

High level water alarms or high level alarms are used to provide a warning. The high level alarm has been designed to detect high water or if there is an increase in volume of water entering a property. The purpose of the high level alarm system is to monitor and send an audible and visual alarm to property owners.



## BATTERY BACK UP

Product Code: DMS281-1

With a Battery Back-up, peace of mind is a standard. Our reliable Battery Back-up will keep your pumps running during power failure, ensuring your package pump station remains working. Our Battery Back-ups are leading the industry in performance.

- Specifically designed for sump pump application
- During power failure will automatically run the sump pump station
- Able to sit in standby mode
- Free standing and can be installed in any dry ventilated area
- Fitted in the power line meaning no additional electrical spurs are required
- Can operate as a standby unit or can be used in conjunction with the AlertMaxx2



# TECHNICAL DRAWINGS

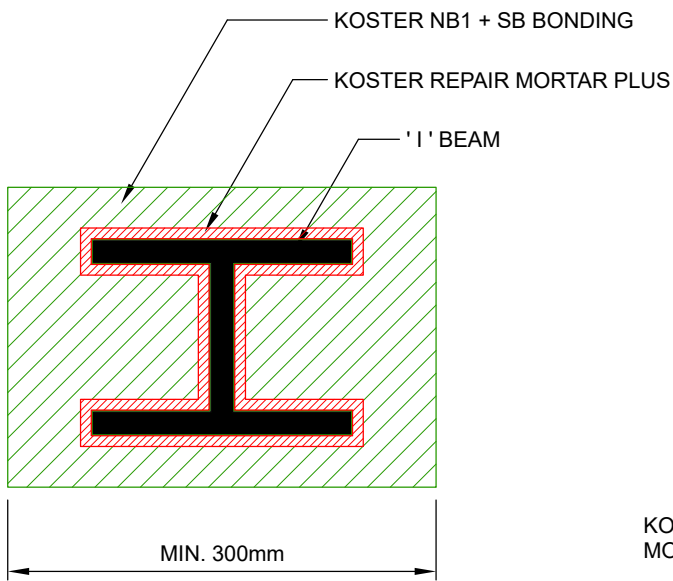

WATERPROOFING TO EXISTING STEEL BEAM END  
KOSTER DETAIL ONLY

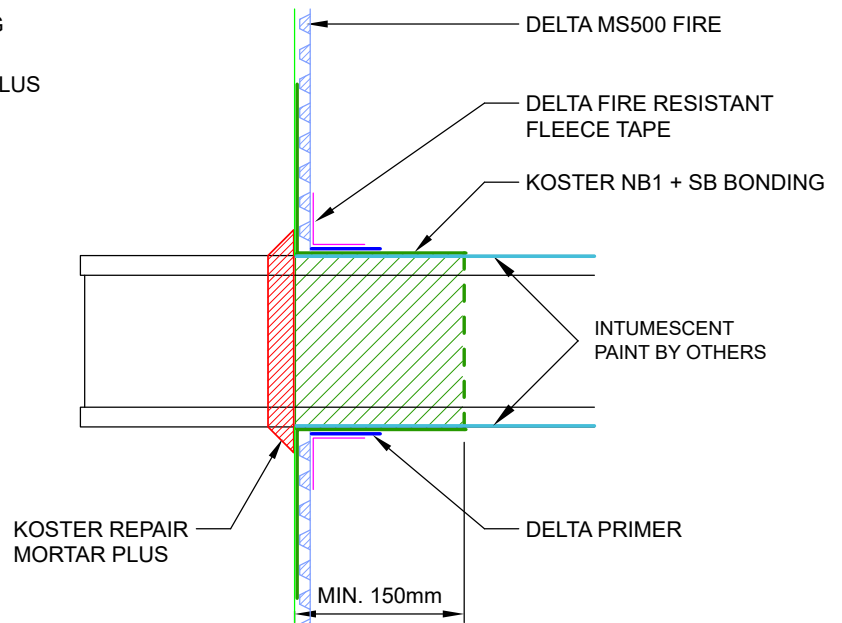

KOSTER + DELTA MS DETAIL

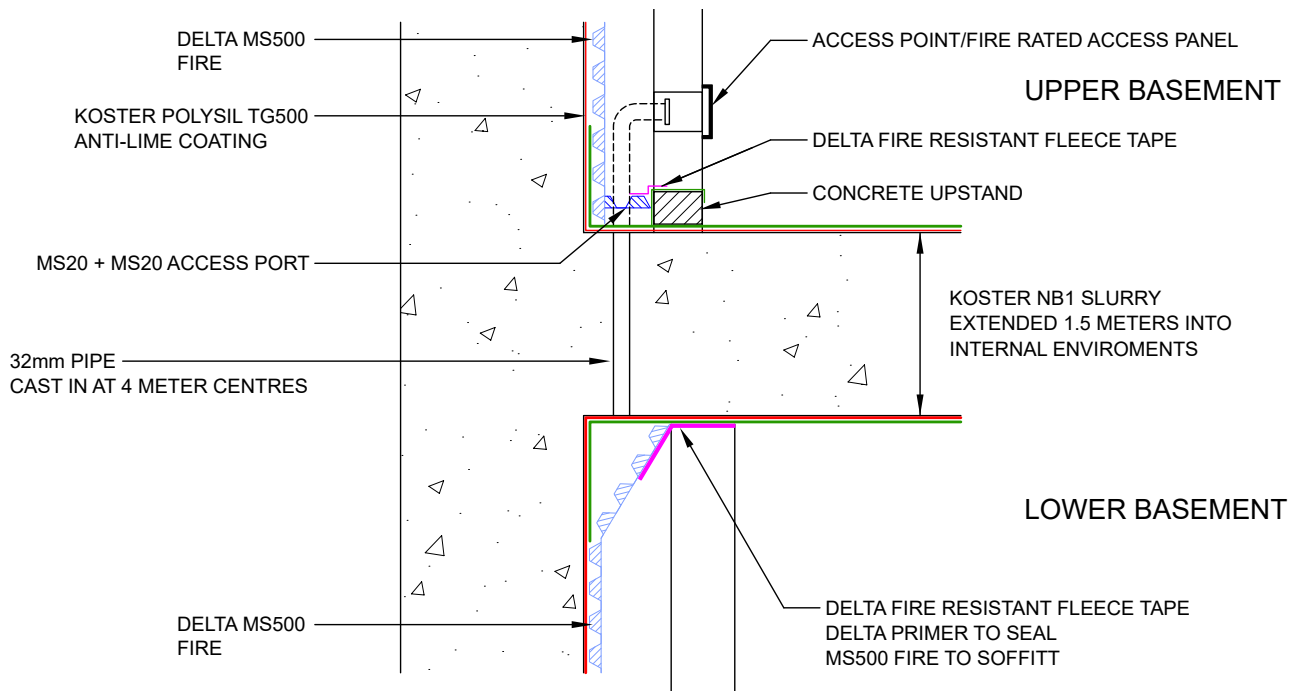

\*DELTA MS500 FIRE FIXED TO WALL WITH DELTA ULTRA FIX PLUGS

INTERMEDIATE SLAB DRAINAGE DETAIL

# TECHNICAL DRAWINGS

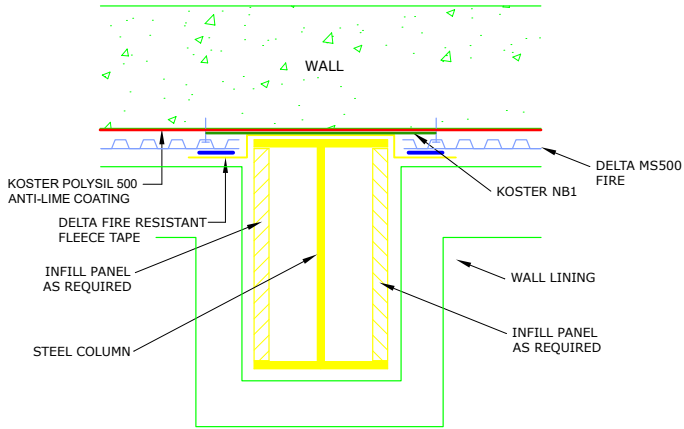

STEEL BEAM DETAIL  
(lapped DPC joint)

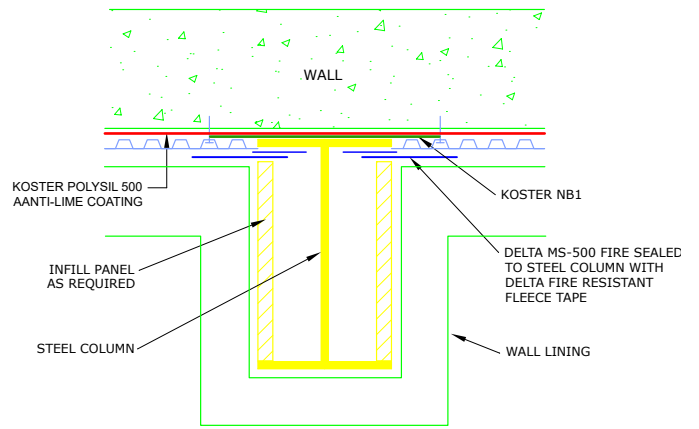

STEEL BEAM DETAIL  
(sealed to steel beam)

## DELTA MS500 FIRE / DELTA BOOT TO STEEL BEAM END

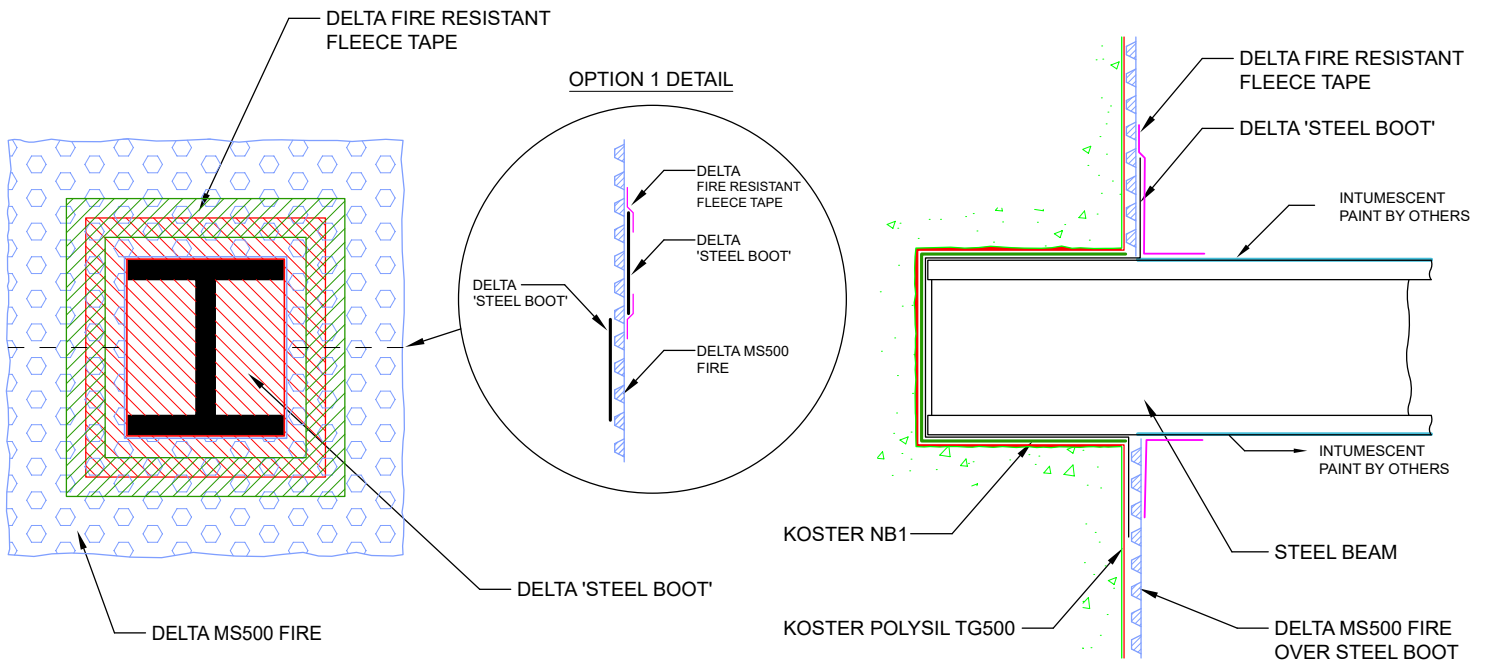



# TECHNICAL DRAWINGS

## DELTA MS500 FIRE - ISOLATING WALL / FIRECHECK

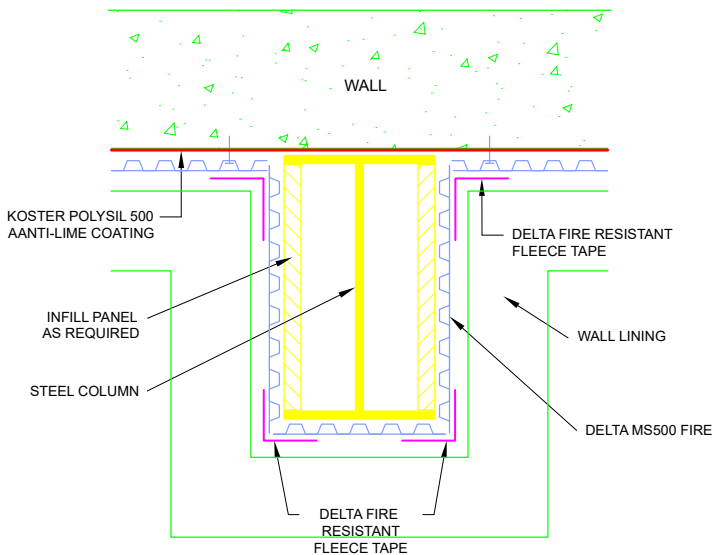
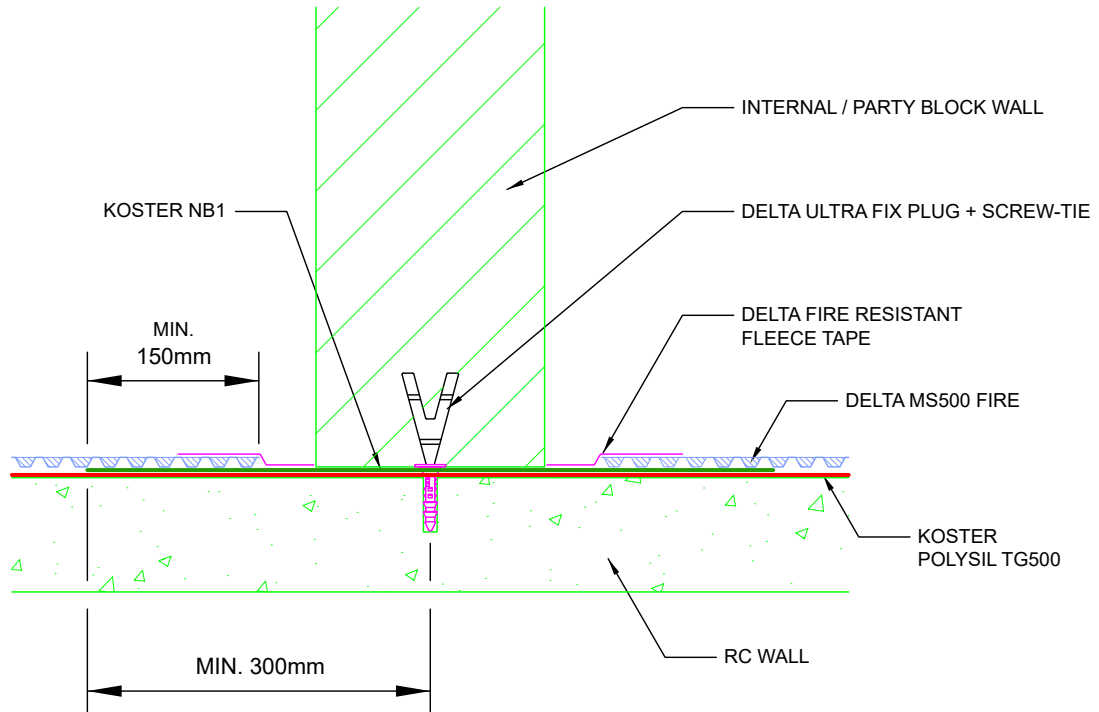

**STEEL BEAM DETAIL  
(taped corners)**

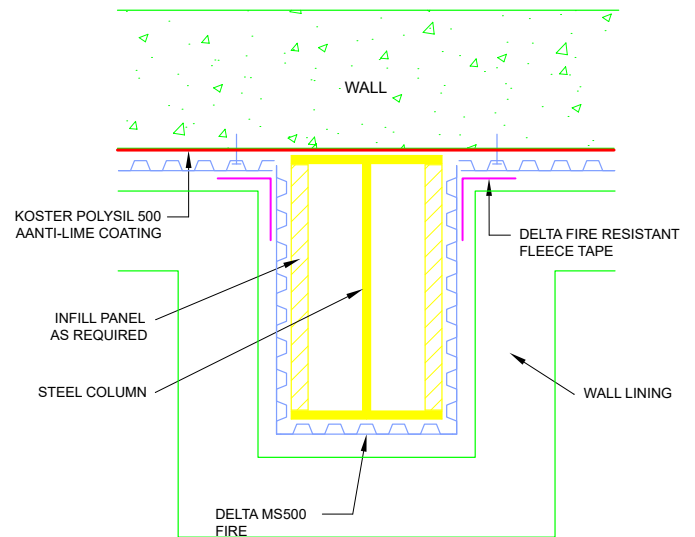

**STEEL BEAM DETAIL  
(continuous membrane)**

# TECHNICAL DRAWINGS

## DELTA - MS FIRE SEALING TO STEEL COLUMN BASE

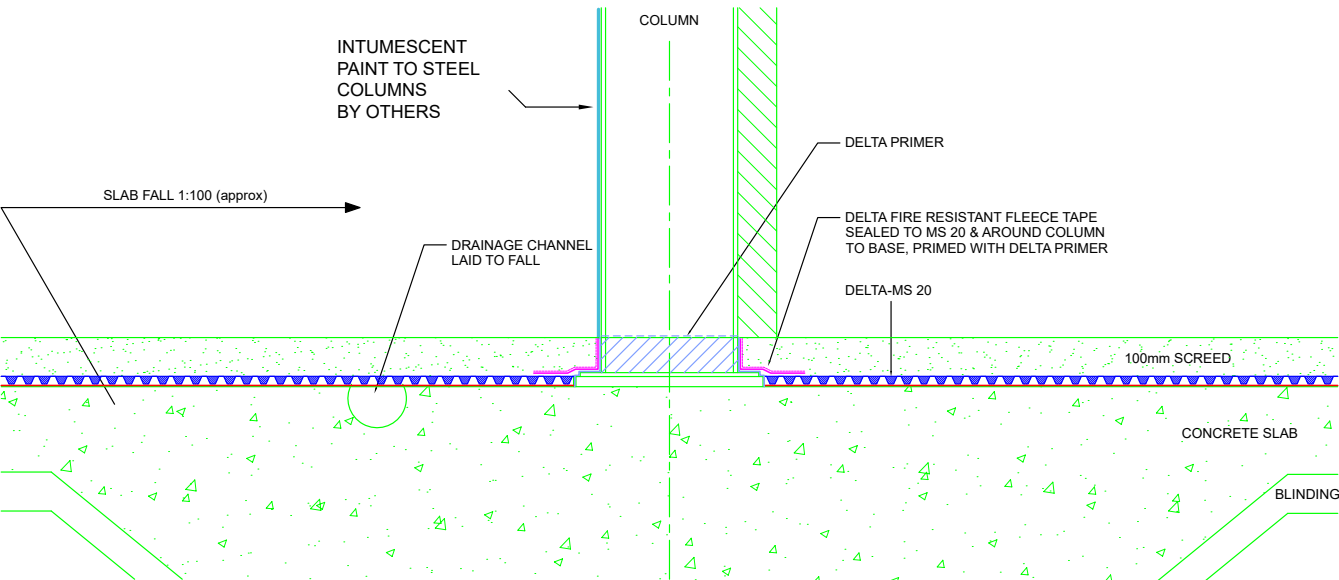

# GUARANTEES

## GUARANTEES

Delta Membrane Systems Limited offer a 30 year Product Guarantee on membranes, seals and fixings when a Delta Cavity Drain System has been installed by a Delta Registered Installer.

## STRUCTURAL WARRANTY PROVIDERS

Delta products are well known and accepted by the NHBC, Premier Guarantee and LABC (to name but a few) and follow the guidance required to ensure a robust design is achieved. Delta Membrane Systems Limited assisted with the writing of the NHBC new Chapter 5.4 and have CSSW qualified staff on hand to assist in all aspects of the design process. A Waterproofing Design Specialist should carry appropriate Professional Indemnity Insurance to cover the design.

## FLOOD TESTING

A requirement for any project before installing a Cavity Drain System below ground is to Flood Test the structure. This is a huge benefit with a Type C form of waterproofing system.

## ADDITIONAL INFORMATION

For additional information or assistance, please contact: Delta Membrane Systems Ltd.  
Tel: 01992 523523 Email: [info@deltamembranes.com](mailto:info@deltamembranes.com)

## AVAILABLE FROM DELTA MEMBRANES

- Installation Guides
- Technical Guidance Literature
- Product Data sheets
- BBA Approval/Third Party Accreditation
- BIM Objects
- CAD Drawings
- CE Marking Certificates
- Delta Training Courses
- RIBA Approved CPD Seminars
- Case Studies
- Design Assistance

