

Uniclass L5367	EPIC E482
Cl/SfB (71.3)	

ACO Water Management: Urban + Landscape

ACO Universal Channel Gully

- ✓ Provides fast and simple connection for all ACO channels up to 200mm bore width
- ✓ Modular system
- ✓ Trapped outlet connection for 150mm supersleeve and 160mm UPVC pipe
- ✓ Access, outfall and silt management function
- ✓ Optional connector for Ø450mm gullies
- ✓ Manufactured from recycled materials
- ✓ D 400 and F 900 options available to BS EN 1433



ACO Universal Channel Gully

High strength modular gully system for access, outfall and silt management

The ACO Universal Gully provides fast and simple connection between any channel size up to 200mm bore width in the ACO channel drainage range.

The high capacity system can be used for silt management and also as an outlet for the drainage system.

The ACO Universal Gully is manufactured from recycled plastic and available with either load class D 400 or F 900 ductile iron gratings and frames compliant to BS EN 1433:2002.

Typical applications

- ▶ Airports
- ▶ Distribution yards
- ▶ Industrial estates
- ▶ Parking areas
- ▶ Ports and docks
- ▶ Retail developments

ACO Universal Channel Gully

Features

- 1 Gully top includes frame, grating and intermediate channel connection unit
- 2 Silt bucket
- 3 Gully base including roddable foul air trap



Ductile iron frame and slotted grating available in Load Class D 400 and F 900 to BS EN 1433:2002

Cutting guide to suit all ACO channels up to 200mm bore

Removable plastic silt bucket

Manufactured from recycled polypropylene

Plain UPVC 150mm - 160mm super sleeve pipe connection



ACO Universal Gully units - D 400 assemblies

Product code	Description	Length (m)	Width overall (m)	Depth overall (mm)	Invert (mm)	Slot width (mm)	Invert type	Weight (kg)
33401	Gully assembly and bucket 601D	440	440	1315	870	10	1	52.5
33402	Gully assembly no bucket 602D	440	440	1315	870	10	1	51
33407	Gully top assembly only 607D	440	440	655	-	10	1	45
44355	Grating and frame 600D	400*	564††	100	-	10	1	40

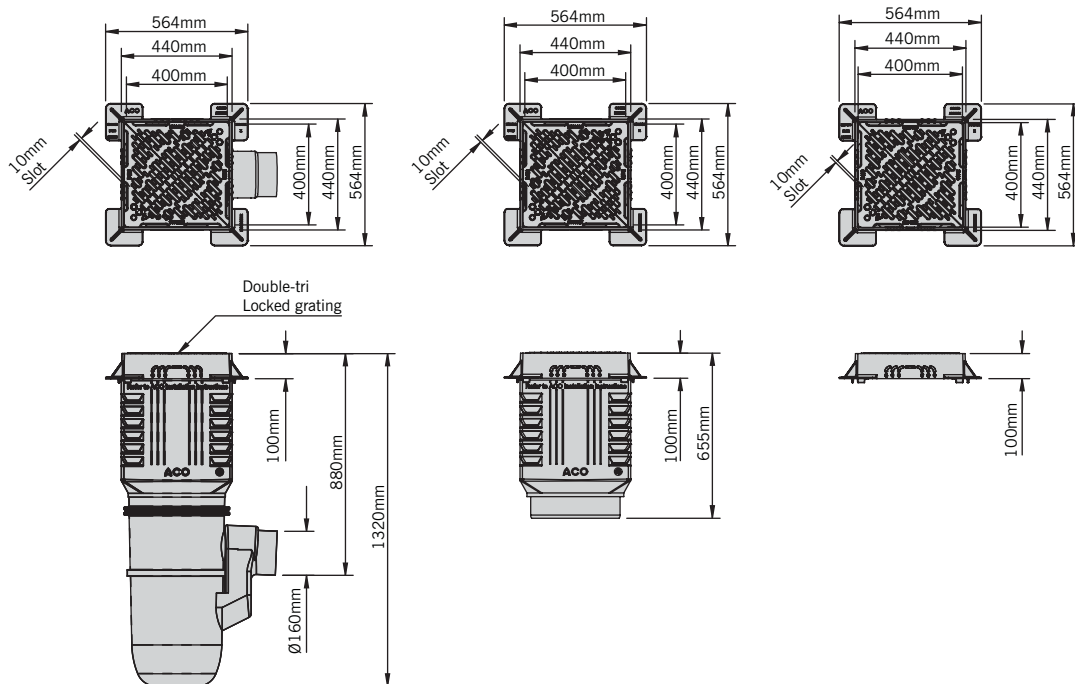

Product code: 33401 and 33402

Product code: 33407

Product code: 44355

* Clear opening size
†† Over frame size

ACO Universal Channel Gully

ACO Universal Gully units - F 900 assemblies

Product code	Description	Length (m)	Width overall (m)	Depth overall (mm)	Invert (mm)	Slot width (mm)	Invert type	Weight (kg)
33601	Gully assembly and bucket 601F	440	440	1315	870	19	1	78.8
33602	Gully assembly no bucket 602F	440	440	1315	870	19	1	77.4
33607	Gully top assembly only 607F	440	440	655	-	19	1	73.1
33604	Grating and frame 604F	400*	660††	100	-	19	1	69.5

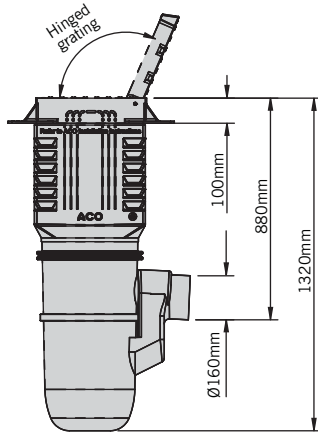
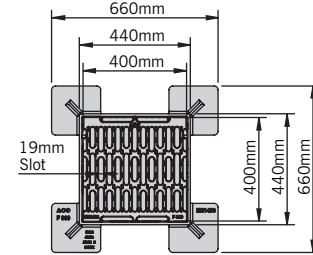
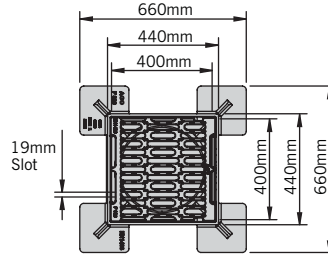
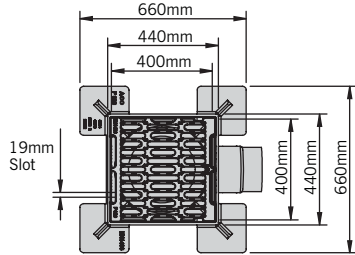

Product code: 33601 and 33602

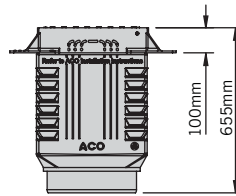

Product code: 33607

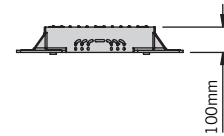

Product code: 33604

ACO Universal Gully components

Product code	Description	Length (m)	Width overall (m)	Depth overall (mm)	Invert (mm)	Invert type	Weight (kg)
7060	Gully connector 615	500	Ø500	40	-	1	7.0
33603	Gully intermediate unit 603	440	440	555	-	1	5.1
33605	Gully base unit 605	-	Ø375	750	310	1	4.3
33606	Bucket polyethylene 606	-	Ø275	245	-	1	1.4

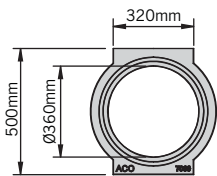

Product code: 7060

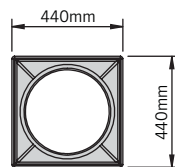

Product code: 33603

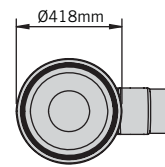

Product code: 33605

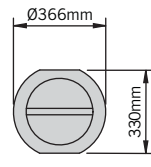

Product code: 33606

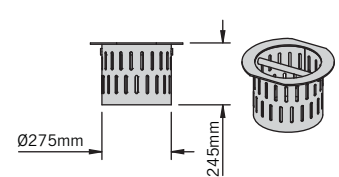
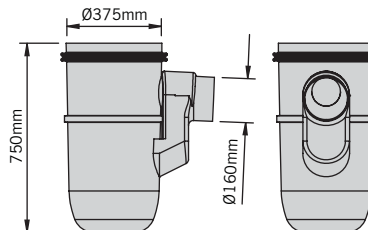
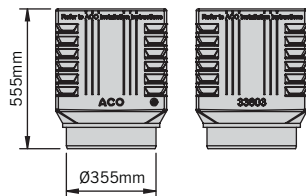
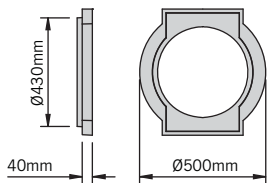

* Clear opening size
†† Over frame size

ACO Universal Channel Gully

Installation details

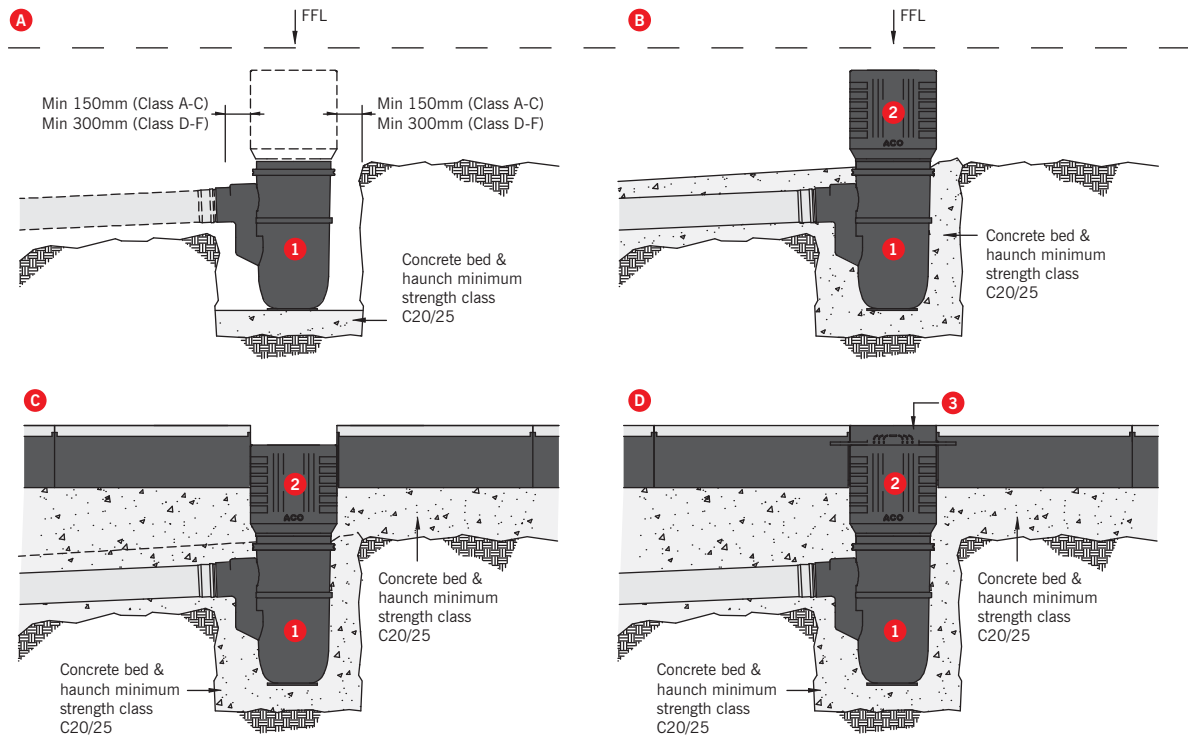

Installation Notes:

- (A): Excavate a 150mm-300mm bed and surround dependent on load class, blind where necessary. Form concrete* bed for base unit **1** and set on mortar (or similar) levelling bed. Make pipe connections (PVCu or Supersleeve) as appropriate.
- (B): Concrete* surround base unit **1** and pipes if required. Position gully intermediate unit **2** to level.
- (C): Concrete* bed for channels allowing levelling mortar bed if required. Extend concrete bed around unit **2** (see fig 1). Install channels (see separate channel installation recommendations) with taped external joints at junction of unit **2** and end of channels.

- (D): Complete concrete* surround to unit **2** allowing for frame levelling bed. Cut out knockouts on gully frame **3** and cut profile of the channel from inside of unit **2**. Install gully and haunch concrete* to the sides of channels as recommended in separate channel installation recommendations.

DESCRIPTIONS:

- 1** - Gully Base Unit. Polyethylene supplied by ACO or base by others
 - 2** - Gully Intermediate Unit. Polyethylene
 - 3** - Gully Top. Comprising of Frame and Grating.
- * - Concrete Bed & Haunch Minimum Strength Class C20/25

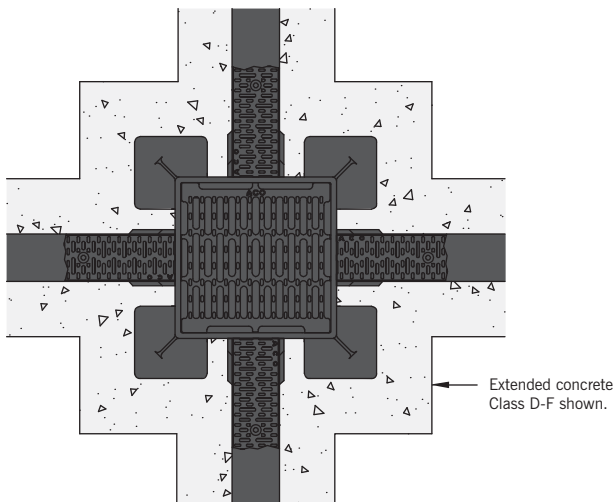
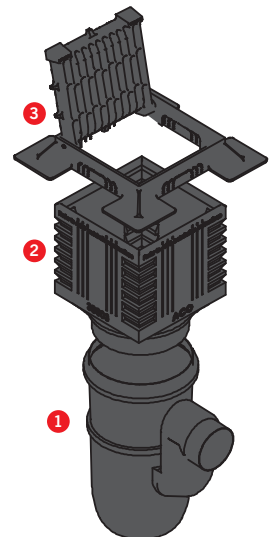

Fig 1:
Shutter around gully top **2** 300mm (Class D-F) or 150mm (Class A-C). Concrete* the supporting surround for the gully frame **3**

ACO Universal Channel Gully

Installation details

1.0 GROUND CONDITIONS:

The long term performance of a gully installation to sustain vertical and lateral wheel loads depends upon a) ground conditions b) stability of the adjacent pavement and c) a durable concrete bed and surround. NOTE that the stability of the gully/concrete surround to resist lateral loads from manoeuvring vehicles should be checked. The dimensions shown on ACO channel installation sketches are those of the laboratory test block and customers should ensure that these minimum dimensions are suitable for the existing ground and service loading conditions. Engineering advice may be necessary.

2.0 BLOCK PAVEMENTS:

THE GULLY MUST BE SUPPORTED LATERALLY if carrying vehicular traffic and therefore blocks laid directly against a gully must be restrained from movement by bedding securely on the concrete haunch e.g. by using an Epoxy or a Polymer Modified Mortar for bed and perpendicular joints (for example RONAFIX Mortar Mix C from Ronacrete: Tel 01279 638700) or similar. Engineering advice may be required. Blocks or slabs bedded on sand remote from the channel should be set at a higher level to compensate for any possible settlement of the paving in service.

3.0 SURFACE CRACKS:

Alternate crack control and movement joints transversely within an exposed concrete bed and haunch may reduce unsightly surface cracking. As the design and layout of such joints is a function of the concrete mix design, the concrete curing regime and the contractor's programme (daywork joints for example) then engineering/contractor advice may be required.

4.0 JOINT SEALANT:

Where ACO channel joints/fittings and channel/concrete/pavement interfaces are to be sealed (where used in foul water or chemical applications for instance) contact a sealant specialist for guidance on the appropriate compound. It should be noted that the preparation of ACO resin concrete channels to receive a sealant does not vary from that required of cement concrete. Guidance on the necessary surface preparation and/or priming should be sought from the sealant manufacturer.

5.0 SURFACE PROTECTION:

With asphalt pavements avoid contact between compaction equipment and gully/grating. This may be achieved by ensuring that the finished surface level lies above the grating level (by at least 3mm). Stones should be removed from grating prior to laying/rolling wearing course. Covering or protecting the grating, before concreting the haunch or laying asphalt, removes the time, and cost, of cleaning the channel and grating of cement/asphalt material and embedded stones.

6.0 MOVEMENT JOINTS:

The gully must be isolated from lateral loads resulting from thermal movement of concrete slabs. A joint may be positioned up to 1.0/1.5m from the gully (UK external installations). In internal applications where temperatures are controlled, possibly within a low range of extremes, joints may not be required. Engineering advice may be necessary. If joints are dowelled then it is imperative that the dowels are aligned correctly in relation to the joint in both vertical and horizontal planes; that they are effectively debonded (with a proprietary sleeve and capping). Cutting of the joint material (to allow dowel fixing for example) must be made good to prevent the passage of concrete through a joint.

7.0 TEMPORARY INSTALLATION:

A gully installation is not complete until the final surfacing is laid. In any temporary condition, i.e. with the gully walls projecting above an asphalt base course or concrete sub-base, site traffic SHOULD NOT CROSS THE GULLY. LOOSE BOARDS; STONE FILL OR COVER PLATES WILL NOT PROTECT THE GULLY WALLS OR GRATING. A temporary crossing should be formed by raising the asphalt base course locally, to 3 - 5mm above grating level, either side of a gully for a distance of 750 to 1000mm, to form ramps. Concrete ramps should be formed in other pavements. NOTE that the gully LOAD CLASS should be adequate to carry the site traffic.

8.0 FURTHER ADVICE:

Refer to ACO Technical and Installation Manuals for further information and advice concerning a) Handling b) Health and Safety c) Maintenance and d) Detailed installation guidance etc., etc. Advice, on any aspect of ACO channel systems, may also be obtained from ACO Water Management Design Services Team.

9.0 BEST PRACTICE AND WORKMANSHIP:

ACO can give guidance with respect to the most suitable methods of installation for each of the products in the ACO range. ACO Universal Gully should be installed using acceptable levels of workmanship and according to the National Code of Practice (UK: BS8000: Part 14: 1989) in keeping with BS EN 1433: 2002 (Drainage channels for vehicular and pedestrian areas). Detailed installation statements and methodologies will vary for all sites as each will have different aspects deserving particular consideration, consequently the relevant approvals should be sought from the consulting engineer and/or the installer.

ACO Technologies plc

ACO Business Park, Hitchin Road, Shefford, Bedfordshire SG17 5TE

Tel: 01462 816666 Fax: 01462 815895

e-mail: technologies@aco.co.uk website: www.aco.co.uk